



Ophthalmic Instrument Catalog



Elevating The Quality Of Care In Ophtha



CONTENTS

Ophthalmic Instrument Catalog

- A** *Section A: Contents Pages*
- B** *Section B: About Rhein Medical & Catalog Information*
- 1.00** *Section 1: Autoclaves & Sterilization Accessories*
- 2.00** *Section 2: Blade Holders*
- 3.00** *Section 3: Stainless Steel Blades*
- 4.00** *Section 4: Calipers, Rulers & Gauges*
- 5.00** *Section 5: Reusable Cannulas*
- 6.00** *Section 6: Single-Use Cannulas & Sterile Products*
- 7.00** *Section 7: Choppers, Non-Irrigating*
- 8.00** *Section 8: Choppers, Irrigating*
- 9.00** *Section 9: Spatulas*
- 10.00** *Section 10: Diamond Knives*
- 11.00** *Section 11: Reusable Knives*
- 12.00** *Section 12: Dilators*
- 13.00** *Section 13: Forceps*
- 14.00** *Section 14: Globe Fixation Instruments*



ELEVATING THE QUALITY OF CARE IN OPHTHALMOLOGY
800-637-4346



CONTENTS

Ophthalmic Instrument Catalog

Section 15:	<i>Hooks & Manipulators</i>	15.00
Section 16:	<i>I/A & Bi-Manual Handpieces & I/A Tips</i>	16.00
Section 17:	<i>INTACS Instruments</i>	17.00
Section 18:	<i>LASEK Instruments</i>	18.00
Section 19:	<i>Manual Lens Fragmentation</i>	19.00
Section 20:	<i>Miscellaneous Instruments</i>	20.00
Section 21:	<i>Needle Holders</i>	21.00
Section 22:	<i>PRK & LASIK & Intralase Instruments</i>	22.00
Section 23:	<i>Retractors</i>	23.00
Section 24:	<i>RK, AK, LRI, CK & Corneal Markers</i>	24.00
Section 25:	<i>Scissors</i>	25.00
Section 26:	<i>Speculums</i>	26.00
Section 27:	<i>Sterilization Trays</i>	27.00
Section 28:	<i>Trephines</i>	28.00
Section 29:	<i>Vitreotomy Instruments</i>	29.00
Section 30:	<i>Numerical Index</i>	30.00



ELEVATING THE QUALITY



1-800-263-3557



CONTENTS

Ophthalmic Instrument Catalog

31.00 *Section 31: Alphabetical Index*



ELEVATING THE QUALITY OF CARE IN OPHTHALMOLOGY
800-637-4346



1-800-263-3557

CONTENTS

Notes

A



ELEVATING THE QUALITY



ACOR

1-800-263-3557







ABOUT RHEIN MEDICAL

About the Catalog

B.00

About the Catalog

All photographs, illustrations, and text in this catalog are the property of Rhein® Medical, Inc. They are copyrighted, and may not be reproduced without the written permission of Rhein Medical.

-  Specifications and prices are subject to change with out notice.
-  All photographs, illustrations, and text in this catalog are the property of Rhein® Medical
-  Rhein Medical and Rhein 3-D Diamond Blade® are registered trademarks of Rhein Medical, Inc.
-  All Rhein® Products Within This Catalog Meet The Requirements Established Within The European Union
-  Background image: The David – Michelangelo, photographed by Richard Radice

All instruments are presented in stainless steel unless otherwise noted. In general, stainless product numbers start with "8," "85," "91," or "99." Titanium product numbers start with "05" except when noted.

Most of our proprietary instruments are offered with a complimentary instructional videotape or videodisc. Should a video be available, the instrument will be accompanied by a videotape symbol next to it.



ELEVATING THE QUALITY OF CARE IN OPHTHALMOLOGY
800-637-4346



Mission Statement

Rhein Medical is dedicated to the design, development, manufacture, and worldwide distribution of unique, innovative and specialized hand-held ophthalmic surgical instruments of the highest quality.

We are one of the very few ophthalmic companies in our industry that directly controls its own manufacturing. We own and operate two manufacturing plants, and are committed to producing and consistently offering only the highest quality products that carry an unconditional lifetime guarantee*. We are devoted to offering the highest degree of customer service in the industry, while continuing our instrument development efforts to elevate the quality of care in ophthalmology. We offer to all surgeons the opportunity to evaluate our products in surgery without obligation, and most of our proprietary instruments carry complimentary instructional videotapes or videodiscs. All Rhein Medical products meet or exceed the requirements established in the European Union and the FDA, and Rhein Medical has passed all U.S. and European regulations and requirements to market its products throughout the world. This is your assurance of the highest in product quality. Our factories are GMP compliant, and ISO certified.

Licenses & Patents

Many of our collaborating surgeons own patents protecting some of the instruments in our Ophthalmic Instrument Catalog, and the rights to those instruments have been licensed to Rhein Medical for distribution. In addition, Rhein Medical also owns certain patents covering instruments and products in this catalog.

***The Rhein Guarantee**

All surgical instruments offered by Rhein Medical are unconditionally guaranteed for life against defects in material and craftsmanship. All irregularities will be repaired or replaced at no cost to our customers.

B.01



ELEVATING THE QUALITY

1-800-263-3557

ABOUT RHEIN MEDICAL

General Company Information

B.02

General Company Information

ORDERS

We employ people at Rhein Medical, not answering machines. When you call us during our normal business hours, you will reach a responsive customer service professional, not an electronic routing system. We will answer your questions, or process your orders, with a minimum of delay. Our most important concern is you. We operate customer service hours from 8:30 AM to 5:00 PM E.S.T., and orders and questions may be presented Monday through Friday during these hours. We offer a toll free telephone number in the U.S.A.: 800-637-4346. Orders or questions may also be presented by facsimile: 813-885-9346, or by email: Info@RheinMedical.com. International calls may be placed by calling our main telephone number: 813-885-5050.

You may also place your questions and orders through our international distribution system. Please contact Rhein Medical or check our website: www.rheinmedical.com for the distributor in your territory or country.

PRICES

Prices are subject to change without notice. Please contact our customer service department for a current price list, or feel free to call for a cost quotation.

SHIPPING

Most shipments are made through UPS using Second Day (Blue) shipping within the U.S.A. However, should you require overnight shipping, please let us know. We also ship through other carriers at our customers' request. The selection of carrier for international shipments is based upon the country of destination. All shipments are F.O.B shipping point (Tampa, Florida). All in-stock orders received by 2:00 PM E.S.T. are shipped on the same day.

TERMS OF PAYMENT

Payments are due within 30 days from receipt of our products. We accept VISA, MasterCard, and American Express credit cards. Wire transfers, personal or cashiers checks drawn on a U.S. bank may also be accepted for international shipments. Cash is also accepted.



Corporate Headquarters of Rhein Medical, Inc.



ELEVATING THE QUALITY OF CARE IN OPHTHALMOLOGY
800-637-4346



1-800-263-3557

ABOUT RHEIN MEDICAL

General Company Information

B.03

RETURN POLICY

Should you wish to return a Rhein product to Rhein Medical, please contact us to receive a Return Authorization Number. All returns must be accompanied by this number. Please protect your return by wrapping it carefully with adequate bubble wrap or other suitable packaging material. Please send the return directly to our office, to the attention of "Returns." Please include a copy of the shipping document, with the account name, number, and address clearly visible so we can credit the proper account. Please tell us why you are returning the product so we can correct the problem. Also, please return it to us within 30 days of your receipt. Please note that special order products cannot be returned for credit.

REPAIR SERVICE

We offer an instrument repair program for all instruments and diamond knives. Since we own and operate our own factories, some repairs can be processed in the same day in which they are received. Our most important concern is pleasing our customers.

INSTRUMENT & DIAMOND KNIFE CARE

Please contact us for instructions on recommended instrument and diamond knife care and maintenance.

OUR TITANIUM

Rhein Medical is known worldwide for its quality in the manufacture of titanium instruments. In fact, our factory is the largest producer of titanium ophthalmic hand-held instruments in the United States. Titanium is maintenance free, non-magnetic, non-corrosive, non-reflective, and weighs less than stainless steel. It offers improved tactile feedback due to its lightweight, and its strength per pound surpasses stainless steel.

OTHER QUESTIONS

Contact our senior executives with any other technical or non technical questions that should arise. We are here for you!



Manufacturing plant of Rhein Medical, Inc.



ABOUT RHEIN MEDICAL

Special Note To Our Customers

B.04

Dear Customer,

Rhein Medical is pleased to present our latest catalog of exquisite hand-held surgical instruments designed for ophthalmic surgery. We have dedicated our company to the design, development, manufacture, and worldwide distribution of unique, innovative and specialized hand-held ophthalmic surgical instruments of the highest quality. We are devoted to offering the highest degree of customer service in the industry, while continuing our instrument development efforts to elevate the quality of care in ophthalmology.

We are one of the few companies in our industry that owns its own manufacturing facilities. Unlike most other ophthalmic companies in the U.S.A., our factories employ our own highly-skilled craftsmen to produce the finest instruments in the world. We also offer an in-house instrument repair program. Repairs can be processed much faster resulting in a quicker turn-around for the customer.

All of our products are offered on surgical evaluation, and can be used in surgery for a limited period of time without obligation. We do not expect you to commit to the purchase of our products until you have tried them in surgery. All instruments carry a lifetime guarantee against defects in material and craftsmanship.

Rhein Medical is registered with the FDA, and has passed all U.S. and European regulations and requirements to market its products throughout the world. This is your assurance of the highest in product quality. Our factories are GMP compliant and are current in CE certification.

We sincerely appreciate your interest in our products, and we hope to have an opportunity to serve you soon.

Sincerely,

Rhein Medical, Inc.



ELEVATING THE QUALITY OF CARE IN OPHTHALMOLOGY
800-637-4346



ABOUT RHEIN MEDICAL

Notes

B.05



ELEVATING THE QUALITY



ACOR

1-800-263-3557



AUTOCLAVES
& Sterilization Accessories

1.00



ELEVATING THE QUALITY OF CARE IN OPHTHALMOLOGY
800-637-4346



1-800-263-3557

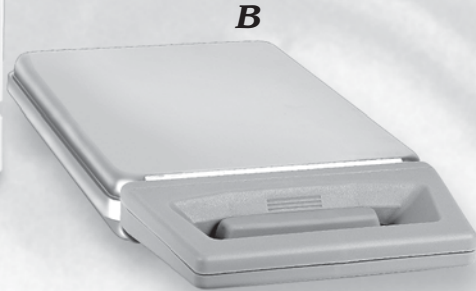

- A) 02-2000 Statim 2000 Cassette Autoclave
- B) 02-2020 Complete Cassette For Statim 2000
- C) 02-5000 Statim 5000 Cassette Autoclave
- D) 02-5001 Statim 5000 Cassette Autoclave With Integral Printer
- E) 02-5015 Complete Cassette For Statim 5000



ELEVATING THE QUALITY



1-800-263-3557



BLADE HOLDERS
Blade Breaker & Holders

2.00

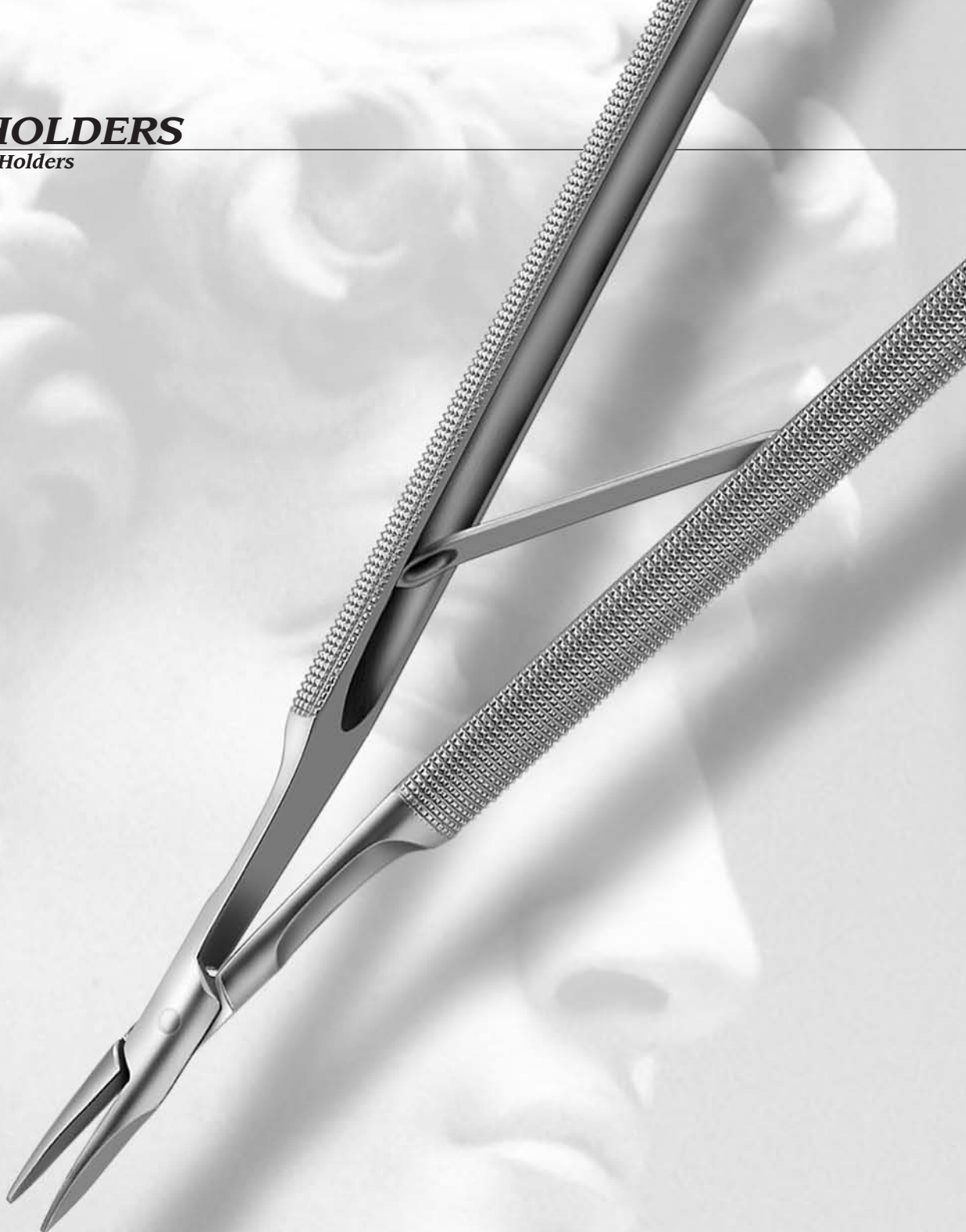

ELEVATING THE QUALITY OF CARE IN OPHTHALMOLOGY
800-637-4346



1-800-263-3557

BLADE HOLDERS

Blade Breaker & Holders

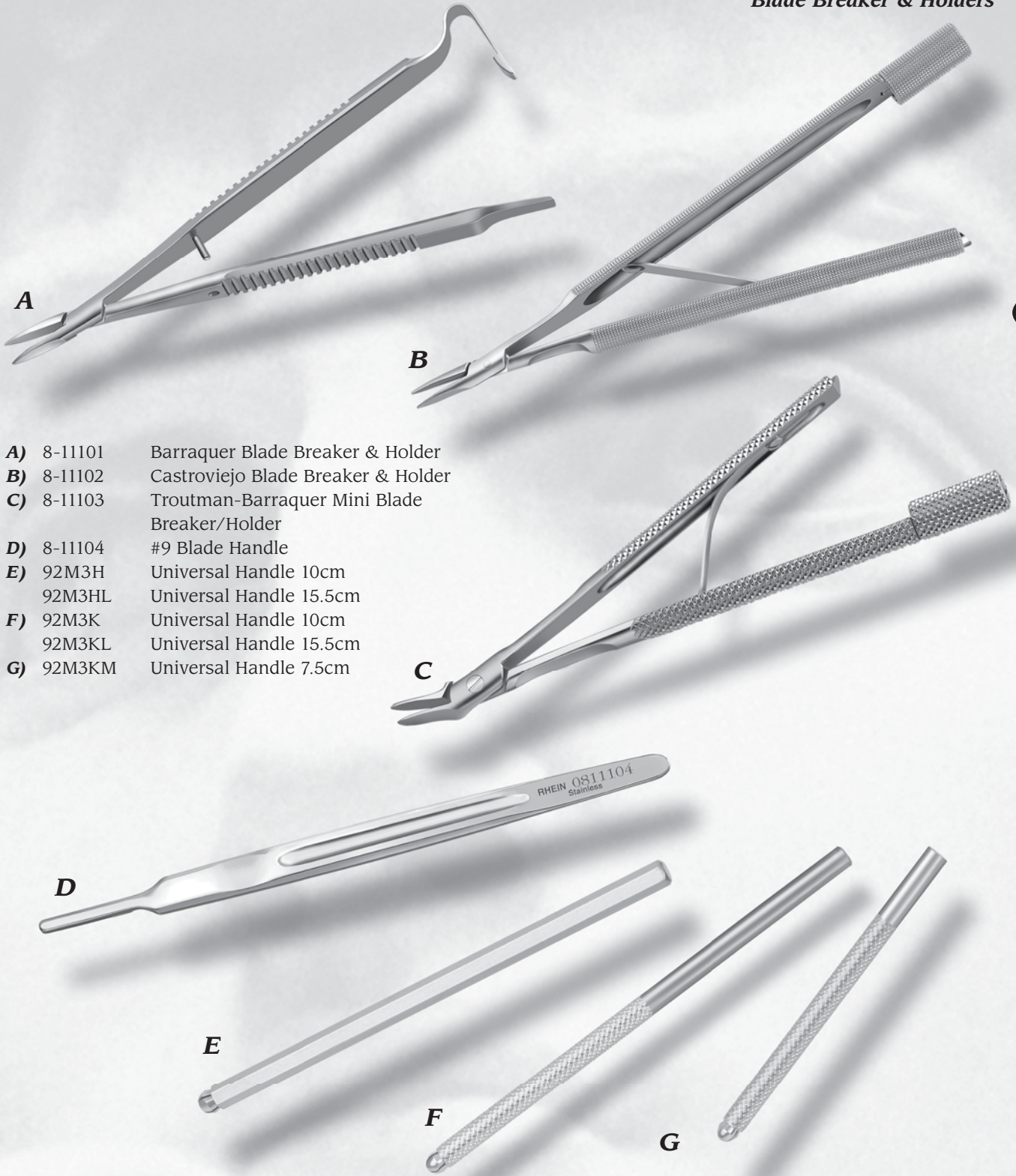

2.01

- A) 8-11101 Barraquer Blade Breaker & Holder
- B) 8-11102 Castroviejo Blade Breaker & Holder
- C) 8-11103 Troutman-Barraquer Mini Blade Breaker/Holder
- D) 8-11104 #9 Blade Handle
- E) 92M3H Universal Handle 10cm
92M3HL Universal Handle 15.5cm
- F) 92M3K Universal Handle 10cm
92M3KL Universal Handle 15.5cm
- G) 92M3KM Universal Handle 7.5cm

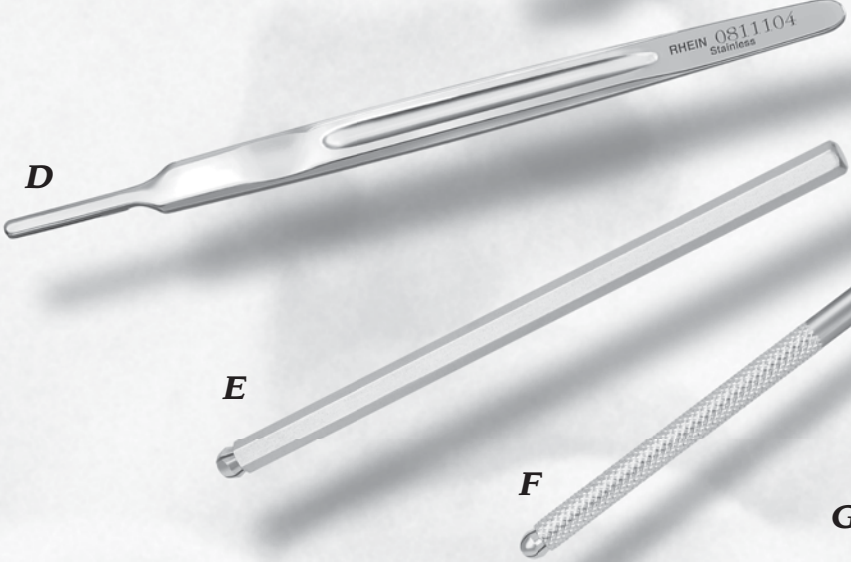

ELEVATING THE QUALITY



ACOR

1-800-263-3557



STAINLESS STEEL BLADES

3.00

- **Phaco**-3.01
- **Sideport**-3.01
- **Spoon**-3.01
- **Crescent**-3.02
- **Stab**-3.03
- **Restricted Stab**-3.03



ELEVATING THE QUALITY OF CARE IN OPHTHALMOLOGY
800-637-4346



STAINLESS STEEL BLADES

Phaco

A

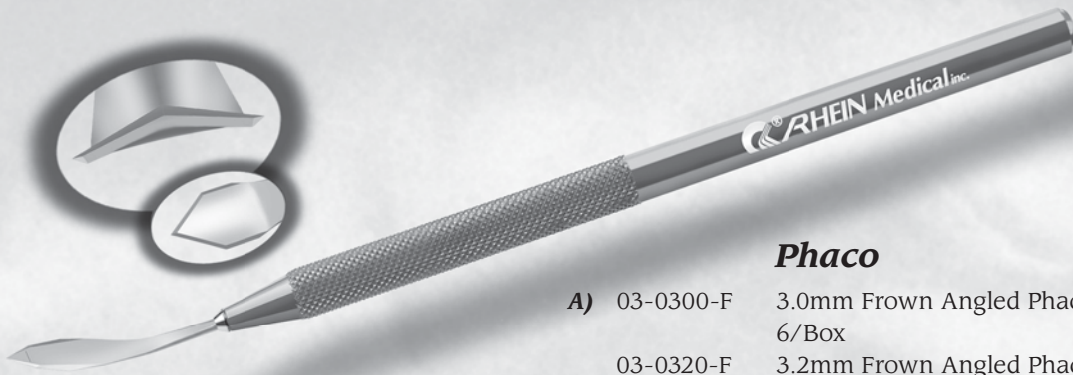

B



C



D



E



F

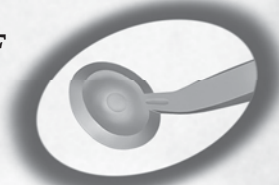

Phaco

- A) 03-0300-F 3.0mm Frown Angled Phaco Blade, 6/Box
- 03-0320-F 3.2mm Frown Angled Phaco Blade, 6/Box
- 03-0250-F 2.5mm Frown Angled Phaco Blade, 6/Box
- 03-0265-F 2.65mm Frown Angled Phaco Blade, 6/Box
- 03-0280-F 2.8mm Frown Angled Phaco Blade, 6/Box
- B) 03-2535 2.5-3.5mm 3-D Trapezoid Angled Phaco Blade, 6/Box
- 03-0250 2.5mm 3-D Angled Phaco Blade, 6/Box
- 03-0265 2.65mm 3-D Angled Phaco Blade, 6/Box
- 03-0280 2.8mm 3-D Angled Phaco Blade, 6/Box
- 03-0300 3.0mm 3-D Angled Phaco Blade, 6/Box
- 03-0320 3.2mm 3-D Angled Phaco Blade, 6/Box
- 03-3011 1.2mm - 1.4mm 3-D Bi-Manual Phaco Blade, 6/Box
- 03-3014 1.4mm 3-D Bi-Manual Phaco Blade, 6/Box
- C) 03-3015 1.0mm-1.4mm-3.0mm 3-D Multipurpose Blade, 6/Box

3.01

Sideport

- D) 03-3010 1.0mm 3-D Side Port Angled Blade, 6/Box
- 03-3006 0.6mm 3-D Side Port Angled Blade, 6/Box
- 03-3007 0.7mm 3-D Side Port Angled Blade, 6/Box
- 03-3008 0.8mm 3-D Side Port Angled Blade, 6/Box
- 03-3009 0.9mm 3-D Side Port Angled Blade, 6/Box

Spoon

- E) 03-4022 2.2mm Angled Spoon Blade, 6/Box
- F) 03-4030 3.0mm Spoon Angled Blade, 6/Box



ELEVATING THE QUALITY



1-800-263-3557



STAINLESS STEEL BLADES

Crescent

3.02

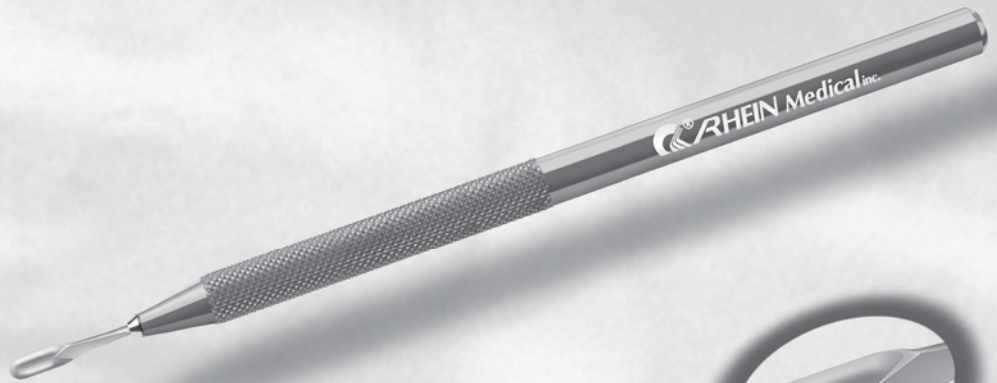

A

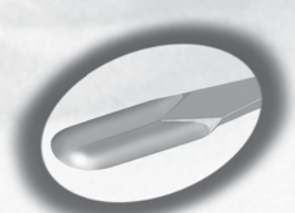

B



C



D

Crescent

- A) 03-5005 Mini Crescent Blades, 1.25mm Angled, Bevel Up, 6/Box
- B) 03-5010 Crescent Blades, 2.0mm Angled, Bevel Up, 6/Box
- C) 03-5020 Crescent Blades, 2.0mm Angled, Bevel Down, 6/Box
- D) 03-5030 Crescent Blades, 2.0mm Angled, Double Bevel, 6/Box



ELEVATING THE QUALITY OF CARE IN OPHTHALMOLOGY
800-637-4346



STAINLESS STEEL BLADES

Stab



A



B



C

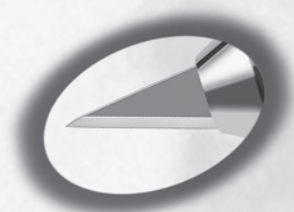

3.03

Stab

- A) 03-6450 45 Degree Stab Super Sharp, 6/Box
- 03-6150 15 Degree Stab Super Sharp, 6/Box
- 03-6225 22.5 Degree Stab Super Sharp, 6/Box
- 03-6300 30 Degree Stab Super Sharp, 6/Box

Restricted Stab

- B) 03-1550 15 Degree Stab Super Sharp, 5.0mm Restricted Blade Depth, 6/Box
- 03-1530 15 Degree Stab Super Sharp, 3.0mm Restricted Blade Depth, 6/Box
- C) 03-3035 30 Degree Stab Super Sharp, 3.5mm Restricted Blade Depth 6/Box
- 03-3030 30 Degree Stab Super Sharp, 3.0mm Restricted Blade Depth, 6/Box



ELEVATING THE QUALITY



CALIPERS, RULERS & GAUGES

4.00



- *Calipers, Rules & Gauges*



ELEVATING THE QUALITY OF CARE IN OPHTHALMOLOGY
800-637-4346



1-800-263-3557

CALIPERS, RULERS & GAUGES

Calipers, Rulers & Gauges

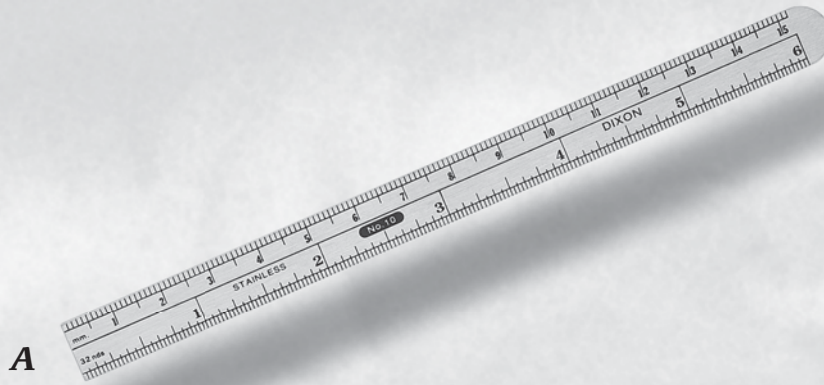

A

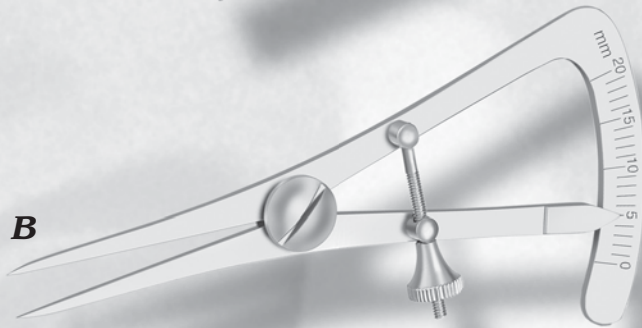

B

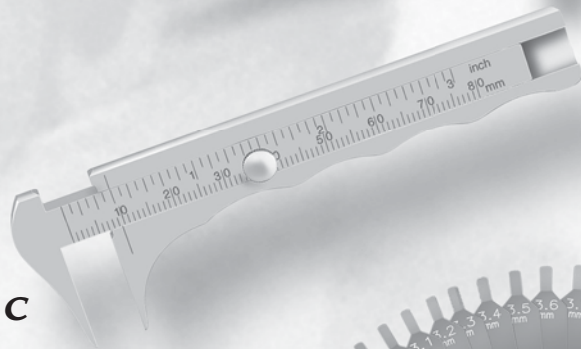

C

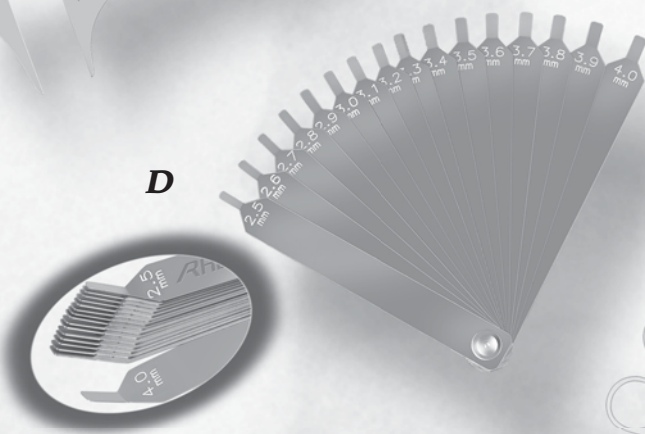

D



E

Calipers, Rulers & Gauges

- A)** 8-12105 Flexible Stainless Ruler, 6" x 1/2"
- B)** 8-12101 Castroviejo Caliper, Straight
- C)** 8-12104 Jameson Caliper
- D)** 8-12110 Rhein Incision Gauges, 100um Increments, 2.5mm - 4.0mm
- E)** 8-12115 Rowen White to White Cornea Gauge

4.01



ELEVATING THE QUALITY



1-800-263-3557



REUSABLE CANNULAS

- **Air Injection/Irrigation**-5.01
- **Alpha-Chymotrypsin**-5.02
- **Capsule Polishers**-5.03
- **Cortex Extraction**-5.04
- **Cyclodialysis**-5.05
- **Hydrodissection**-5.06
- **I & A Cannulas**-5.08
- **Irrigating Vectis**-5.09
- **Irrigating Choppers**-5.10
- **Lacrimal**-5.10
- **LASIK & LASEK**-5.11
- **Miscellaneous**-5.14
- **Retrobulbar Peribulbar & Subtenon**-5.16

5.00

Most of our irrigating and aspirating cannulas have irrigation on the tubing hubs and aspiration on the needle hubs. The cannulas have 304 series stainless steel working tips and the hubs are 300 Series Stainless. Each cannula undergoes a rigorous qualification process to ensure proper functionality with no bio-compatibility consequences. All cannulas can be disinfected or autoclaved using common sterilization protocol.

Function Symbols

The following symbols are illustrated throughout the section for quick function identification:

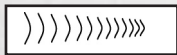

Aspiration



Irrigation



GAUGE CONVERSION CHART				
Gauge	ID* (inch)	ID* (mm)	OD** (inch)	OD** (mm)
19g	.028	.70	.043	1.10
20g	.024	.60	.036	.90
21g	.020	.51	.032	.80
22g	.016	.41	.028	.70
23g	.013	.33	.025	.60
24g	.012	.30	.022	.55
25g	.010	.25	.020	.50
26g	.010	.25	.018	.45
27g	.008	.20	.016	.40
28g	.007	.18	.014	.36
29g	.007	.18	.013	.33
30g	.006	.15	.012	.30

*Inner Diameter



ELEVATING THE QUALITY OF CARE IN OPHTHALMOLOGY
800-637-4346



REUSABLE CANNULAS

Air Injection/Irrigation

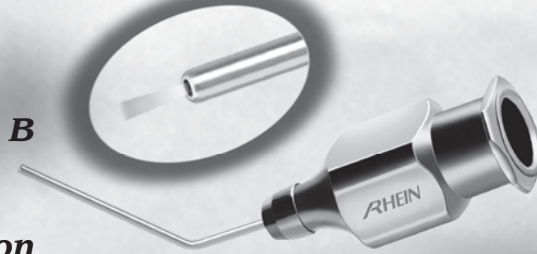
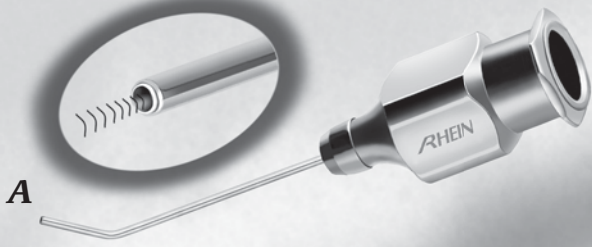

Air Injection/Irrigation

- A)** 91-7024 Air Injection Cannula, 25g, 5mm Tip
- 91-7025 Air Injection Cannula, 27g, 5mm Tip
- 91-7026 Air Injection Cannula, 27g, 7mm Tip
- 91-7030 Air Injection Cannula, 30g, 5mm Tip
- 91-7027 Air Injection Cannula, 30g, 7mm Tip
- B)** 91-7127 Angled Anterior Chamber Cannula, 23g
Angled, 12mm Tip
- 91-7128 Angled Anterior Chamber Cannula, 26g
- C)** 91-1105 Bishop-Harmon Cannula, w/Bulb &
Adapter
- 91-1101 Bishop-Harmon Adapter For Squeeze
Bulb
- 91-1100 Silicon Squeeze Bulb
- D)** 91-7035 Bishop-Harmon Cannula, 19g, 7mm Tip,
24mm
- E)** 91-1001 Delron Irrigating Handle, Male/Female
Fittings, 75mm Length
- F)** 91-1000 Delron Irrigating Handle, Two Male
Fittings Same Size, 75mm in Length
- G)** 91-1002 Delron Irrigating Handle, Two Male
Fittings Different Sizes, 75mm & 100mm
In Length

5.01



ELEVATING THE QUALITY

ACOR

1-800-263-3557



REUSABLE CANNULAS

Air Injection/Irrigation

5.02

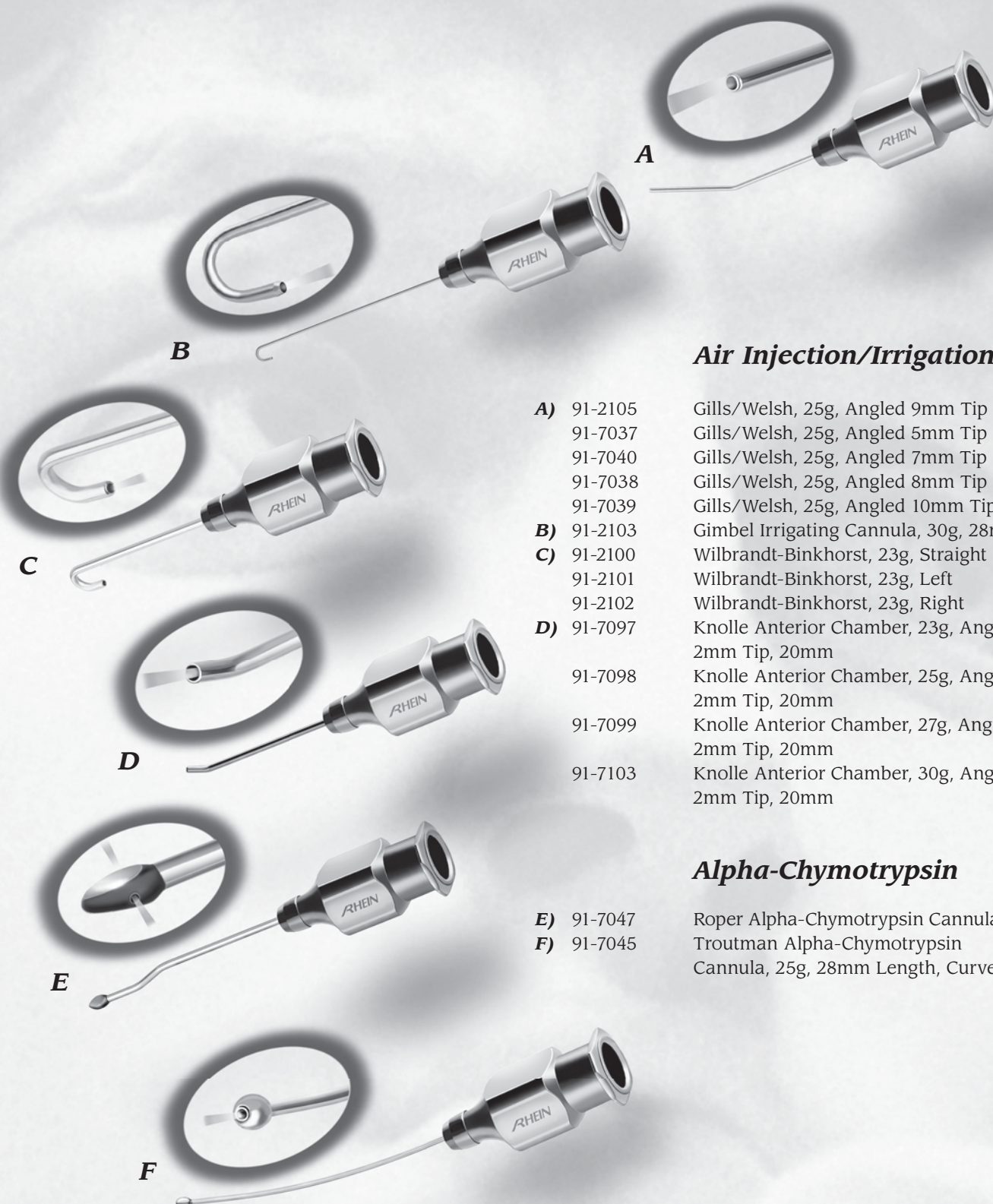

Air Injection/Irrigation

- A)** 91-2105 Gills/Welsh, 25g, Angled 9mm Tip
 91-7037 Gills/Welsh, 25g, Angled 5mm Tip
 91-7040 Gills/Welsh, 25g, Angled 7mm Tip
 91-7038 Gills/Welsh, 25g, Angled 8mm Tip
 91-7039 Gills/Welsh, 25g, Angled 10mm Tip
- B)** 91-2103 Gimbel Irrigating Cannula, 30g, 28mm
- C)** 91-2100 Wilbrandt-Binkhorst, 23g, Straight
 91-2101 Wilbrandt-Binkhorst, 23g, Left
 91-2102 Wilbrandt-Binkhorst, 23g, Right
- D)** 91-7097 Knolle Anterior Chamber, 23g, Angled 2mm Tip, 20mm
 91-7098 Knolle Anterior Chamber, 25g, Angled 2mm Tip, 20mm
 91-7099 Knolle Anterior Chamber, 27g, Angled 2mm Tip, 20mm
 91-7103 Knolle Anterior Chamber, 30g, Angled 2mm Tip, 20mm

Alpha-Chymotrypsin

- E)** 91-7047 Roper Alpha-Chymotrypsin Cannula, 19g
- F)** 91-7045 Troutman Alpha-Chymotrypsin Cannula, 25g, 28mm Length, Curved



ELEVATING THE QUALITY OF CARE IN OPHTHALMOLOGY
 800-637-4346



1-800-263-3557

REUSABLE CANNULAS

Capsule Polishers

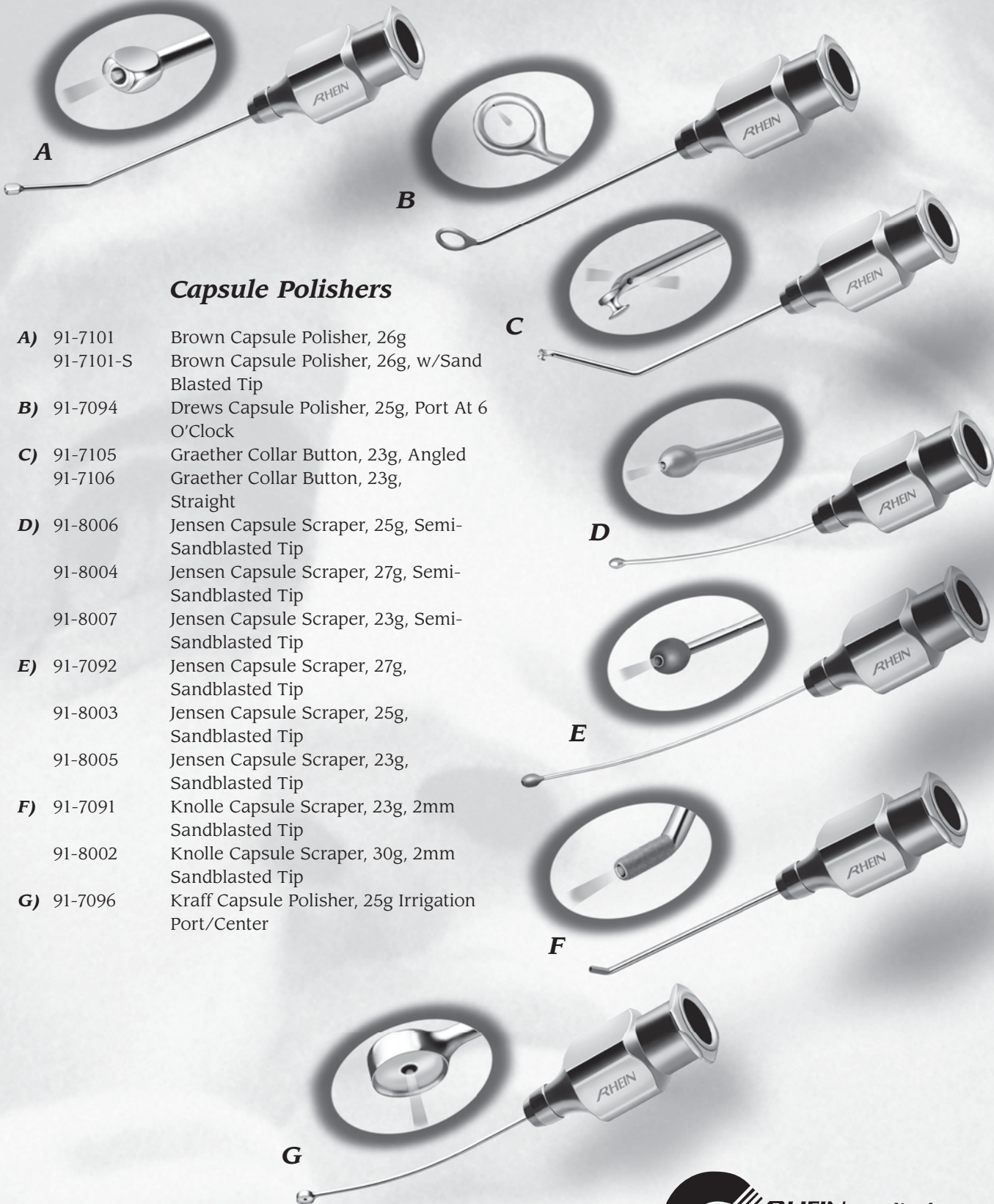

Capsule Polishers

- A)** 91-7101 Brown Capsule Polisher, 26g
91-7101-S Brown Capsule Polisher, 26g, w/Sand Blasted Tip
- B)** 91-7094 Drews Capsule Polisher, 25g, Port At 6 O'Clock
- C)** 91-7105 Graether Collar Button, 23g, Angled
91-7106 Graether Collar Button, 23g, Straight
- D)** 91-8006 Jensen Capsule Scraper, 25g, Semi-Sandblasted Tip
91-8004 Jensen Capsule Scraper, 27g, Semi-Sandblasted Tip
91-8007 Jensen Capsule Scraper, 23g, Semi-Sandblasted Tip
- E)** 91-7092 Jensen Capsule Scraper, 27g, Sandblasted Tip
91-8003 Jensen Capsule Scraper, 25g, Sandblasted Tip
91-8005 Jensen Capsule Scraper, 23g, Sandblasted Tip
- F)** 91-7091 Knolle Capsule Scraper, 23g, 2mm Sandblasted Tip
91-8002 Knolle Capsule Scraper, 30g, 2mm Sandblasted Tip
- G)** 91-7096 Kraff Capsule Polisher, 25g Irrigation Port/Center

5.03



ELEVATING THE QUALITY



1-800-263-3557



REUSABLE CANNULAS

Capsule Polishers

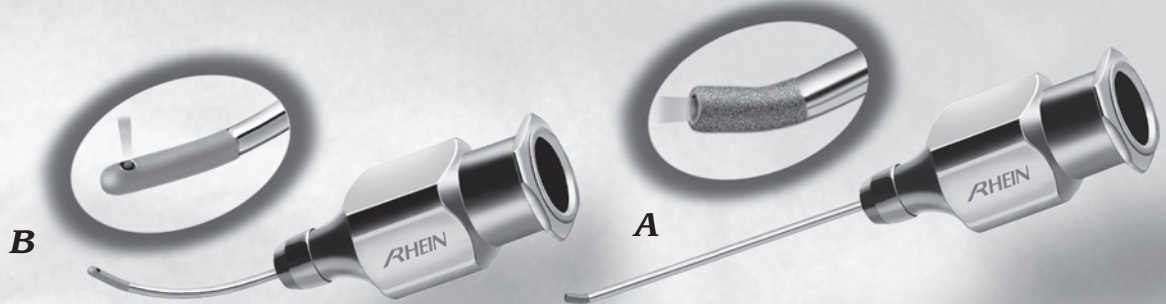

Capsule Polishers

- A) 91-7090 Kratz Capsule Scraper, 23g, 1mm Sandblasted Tip
- B) 91-7093 Simcoe Capsule Scraper, 23g, 13mm Length
- C) 91-7093-R Simcoe Reverse Aperture Posterior Scrubber, 23g, 13mm

Cortex Extraction

- D) 91-7067 Binkhorst-McIntyre, 26g, Cannula, 18mm Straight Shaft
- E) 91-7069 Binkhorst Cannula 22g Left, 18mm Length
- 91-7068 Binkhorst Cannula 22g Right, 18mm Length
- 91-7061 Binkhorst-McIntyre, 26g, Cannula, 18mm Right
- 91-7062 Binkhorst-McIntyre, 26g, Cannula, 18mm Left
- F) 91-7110 J-Shaped Cannula, 21g
- 91-7111 J-Shaped Cannula, 23g
- 91-7112 J-Shaped Cannula, 25g
- 91-7114 J-Shaped Cannula, 26g
- G) 91-7041 Simcoe Cortex Extractor, 23g, 0.3mm Port, 13mm
- 91-7042 Simcoe Cortex Extractor, 23g, 0.3mm Port, 21mm
- 91-7058 Simcoe Cortex Extractor, 23g, 0.4mm Port, 21mm

5.04



ELEVATING THE QUALITY OF CARE IN OPHTHALMOLOGY
800-637-4346



1-800-263-3557

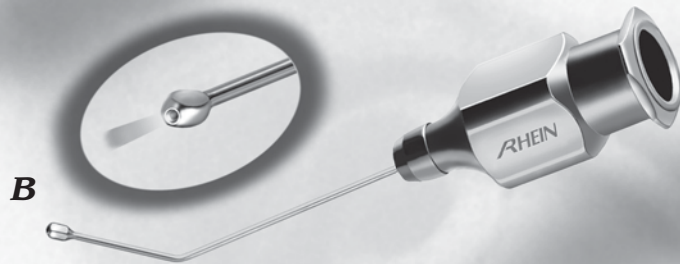
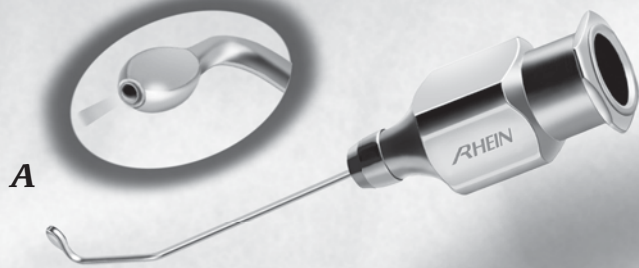

Cortex Extraction

- A)** 91-7044 Welsh Flat Olive Cortex Extractor, 25g, Left
- 91-7043 Welsh Flat Olive Cortex Extractor, 25g, Right
- B)** 91-7046 Welsh Flat Olive Cortex Extractor, 25g, Straight



Cyclodialysis

- C)** 91-7050 Kelman Cyclodialysis Cannula, 19g, Flat Right
- 91-7051 Kelman Cyclodialysis Cannula, 19g, Flat Left
- D)** 91-7052 Randolph Cyclodialysis, 19g, Front Opening
- 91-7053 Randolph Cyclodialysis, 21g, Front Opening



5.05



REUSABLE CANNULAS

Hydrodissection

5.06

Hydrodissection

- A)** 91-7129 Hydrodissection Cannula J-Shaped, 30g, Straight
- 91-7130 Hydrodissection Cannula, 30g, Angled
- 91-7131 Hydrodissection Cannula J-Shaped, 23g, Straight
- 91-7133 Hydrodissection Cannula J-Shaped, 27g, Straight
- 91-7137 Hydrodissection Cannula J-Shaped, 25g, Straight
- 91-7132-A Hydrodissection Flattened Cannula, 23g, Angled
- B)** 91-7133-A Hydrodissection Flattened Cannula, 25g, Angled
- C)** 91-7134-A Hydrodissection Flattened Cannula, 25g, Angled
- 91-7135-A Hydrodissection Flattened Cannula 27g, Angled
- 91-7136-A Hydrodissection Flattened Cannula 30g, Angled
- D)** 91-7132-S Hydrodissection Flattened Cannula, 23g, Straight
- 91-7134-S Hydrodissection Flattened Cannula, 25g, Straight
- 91-7135-S Hydrodissection Flattened Cannula 27g, Straight
- 91-7136-S Hydrodissection Flattened Cannula 30g, Straight

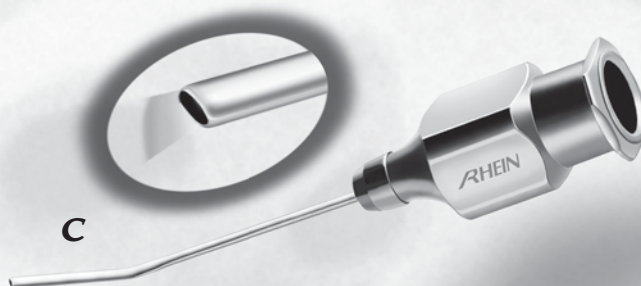

ELEVATING THE QUALITY OF CARE IN OPHTHALMOLOGY
800-637-4346



REUSABLE CANNULAS

Hydrodissection

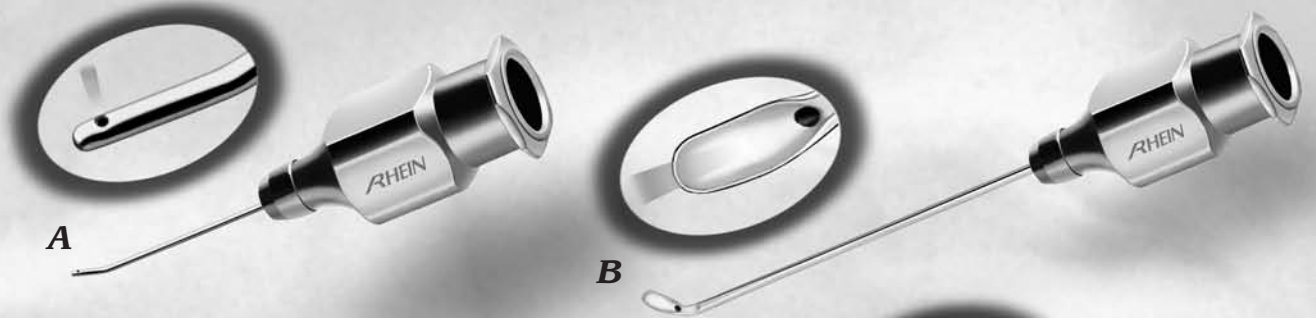

Hydrodissection

- A) 91-7138 Kellan Hydro-Elevation 27g Cannula
- B) 91-7141 Khouri Hydrodissection Cannula, 23g, Left
- 91-7142 Khouri Hydrodissection Cannula, 23g, Right
- C) 91-7206 Utrata 27g Hydrodissection "J" Cannula
- D) 91-8011 McIntyre III 27g Hydrodissection Cannula
- E) 91-8012 McIntyre III 21g Debulking Cannula
- F) 91-8016 Ruminson Hydrodissection Luxation Cannula
- G) 91-8032 Chang 27g Hydrodissection Cannula, Short 90 Degree Beveled Tip

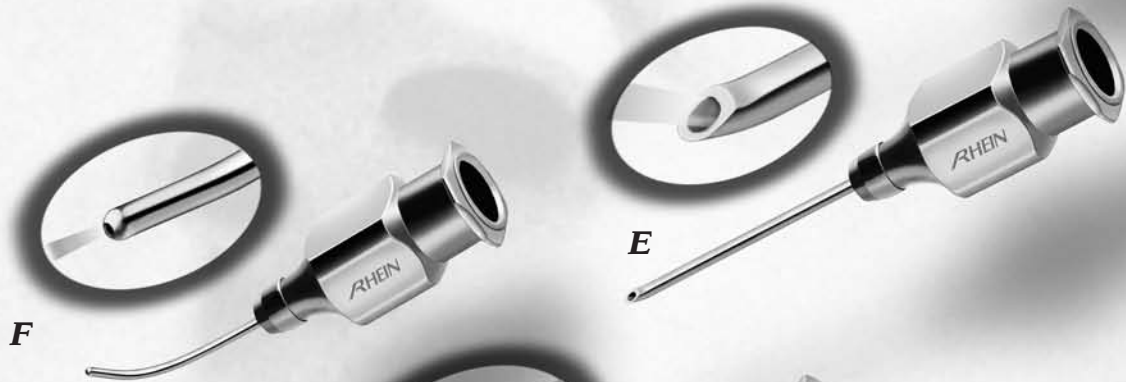

5.07



ELEVATING THE QUALITY



1-800-263-3557



REUSABLE CANNULAS

Hydrodissection

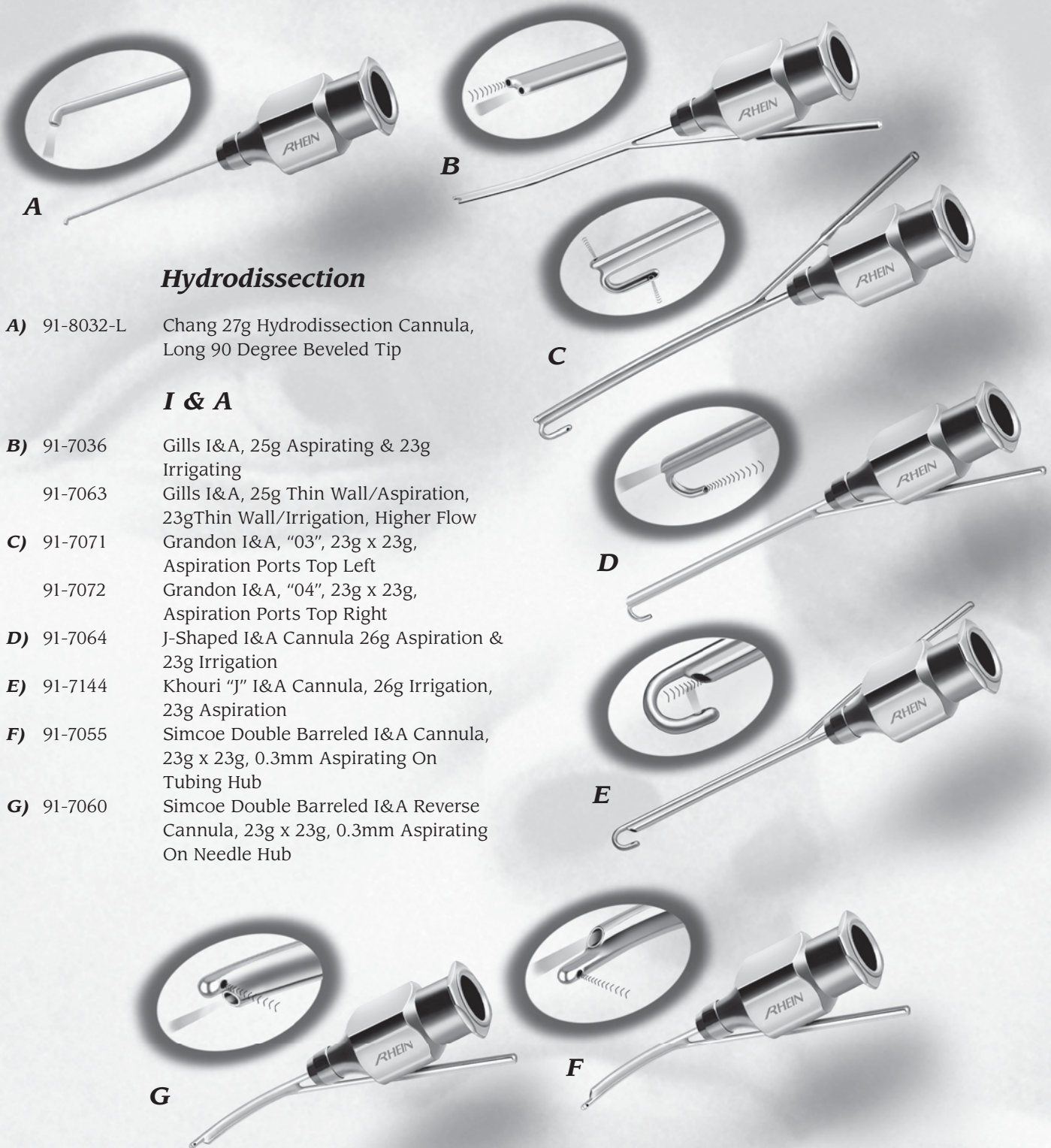

Hydrodissection

- A) 91-8032-L Chang 27g Hydrodissection Cannula, Long 90 Degree Beveled Tip

I & A

- B) 91-7036 Gills I&A, 25g Aspirating & 23g Irrigating
- 91-7063 Gills I&A, 25g Thin Wall/Aspiration, 23g Thin Wall/Irrigation, Higher Flow
- C) 91-7071 Grandon I&A, "03", 23g x 23g, Aspiration Ports Top Left
- 91-7072 Grandon I&A, "04", 23g x 23g, Aspiration Ports Top Right
- D) 91-7064 J-Shaped I&A Cannula 26g Aspiration & 23g Irrigation
- E) 91-7144 Khouri "J" I&A Cannula, 26g Irrigation, 23g Aspiration
- F) 91-7055 Simcoe Double Barreled I&A Cannula, 23g x 23g, 0.3mm Aspirating On Tubing Hub
- G) 91-7060 Simcoe Double Barreled I&A Reverse Cannula, 23g x 23g, 0.3mm Aspirating On Needle Hub

5.08



ELEVATING THE QUALITY OF CARE IN OPHTHALMOLOGY
800-637-4346



REUSABLE CANNULAS

Irrigating Vectis



A



B



C



D



E



F

Irrigating Vectis

- A)** 91-7143 Khouri 3mm Nucleus Removal Spoon
- B)** 91-7065 Knolle/Pearce Vectis, 23g, 3 Outer Ports
- C)** 91-7076 Lens Loop 3mm Wide, 3 Ports
- D)** 91-7122 McIntyre II 3mm Irrigating Removal Spoon, Small
- 91-7123 McIntyre II 4.5mm Irrigating Removal Spoon, Large
- E)** 91-7066-S Sheets Irrigation Vectis, 23g With Serrations
- 91-7066 Sheets Irrigation Vectis, 23g Without Serrations
- F)** 91-7070 Simcoe Nucleus Loop Left, 25g, Two Ports, 4mm
- 91-7075 Simcoe Nucleus Loop Right, 25g, Two Ports, 4mm

5.09



ELEVATING THE QUALITY



1-800-263-3557



REUSABLE CANNULAS

Irrigating Choppers

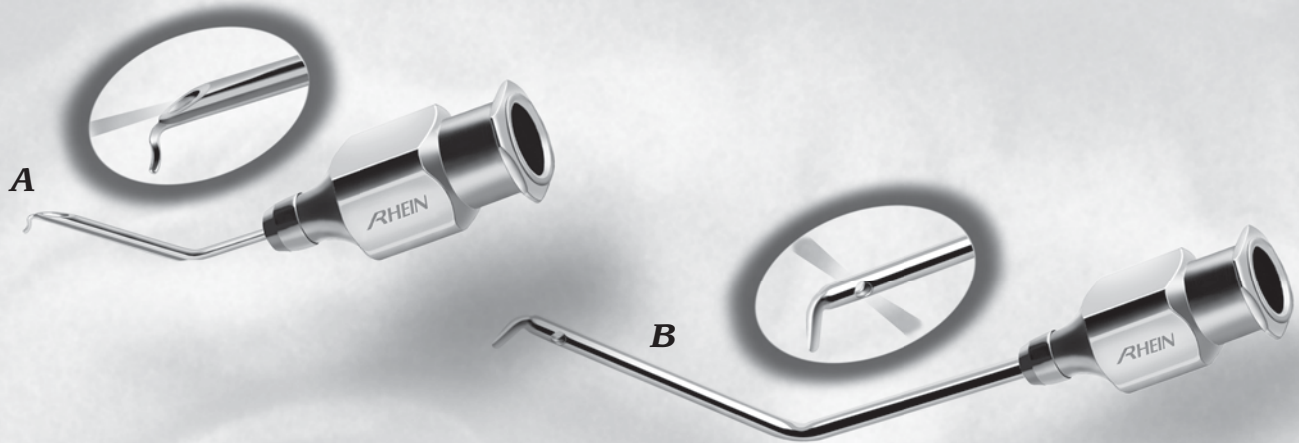

Irrigating Choppers

- A) 91-7145 Gillum Irrigating Phaco Splitter
- B) 91-7146 Olson 21g Irrigating Quick Chopper, Right Hand Dominant Surgeon
- 91-7146-L Olson 21g Irrigating Quick Chopper, Left Hand Dominant Surgeon
- C) 91-8034 Chang 20g Irrigating Chopper, Right Curve



Lacrimal

- D) 91-7115 Lacrimal Cannula, 23g, Straight 25mm
- E) 91-7117 Lacrimal Cannula, 23g, Curved Reinforced 20mm
- 91-7116 Lacrimal Cannula, 23g, Straight Reinforced 20mm



D



E



ELEVATING THE QUALITY OF CARE IN OPHTHALMOLOGY
800-637-4346



REUSABLE CANNULAS

LASIK & LASEK

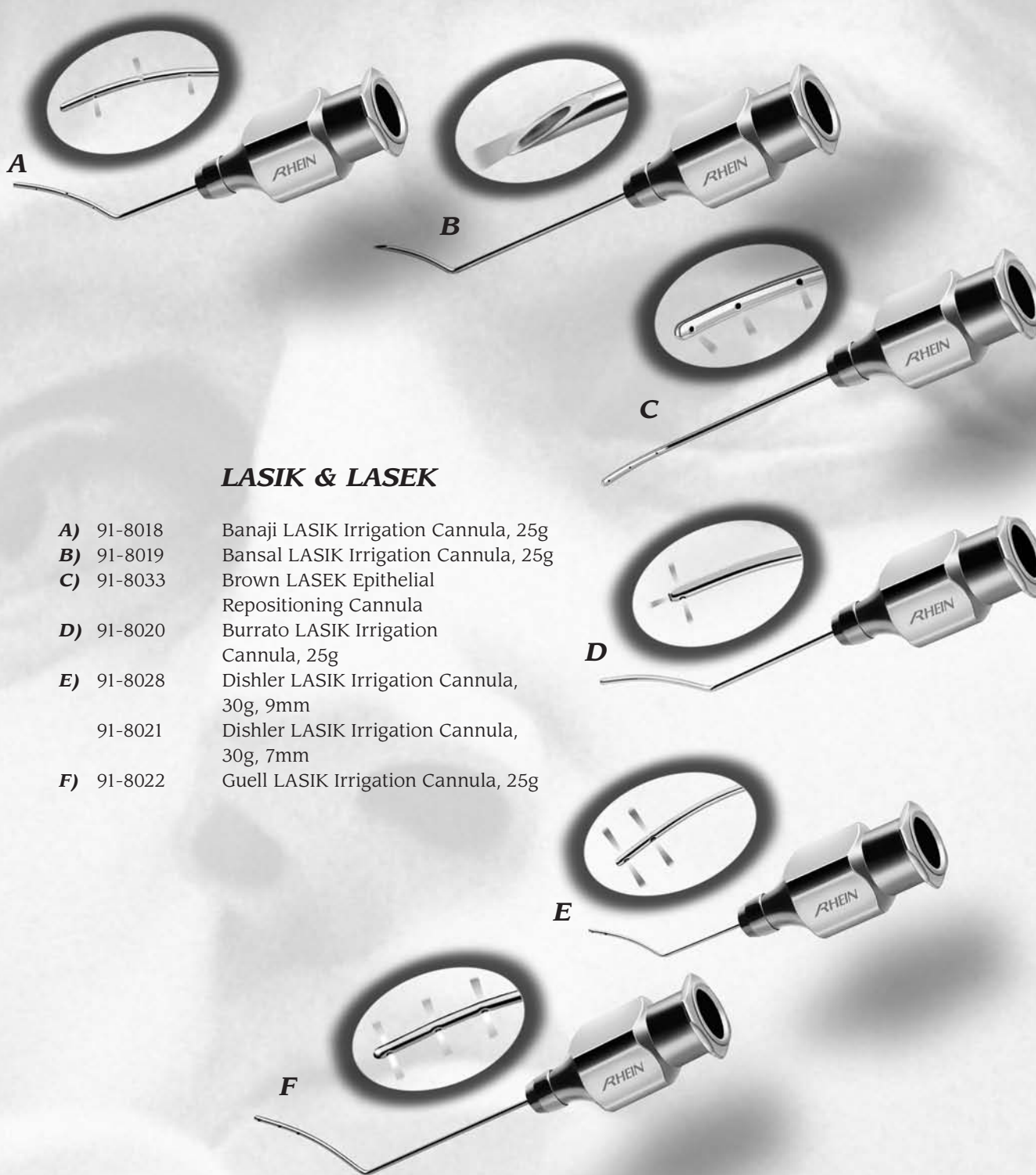

LASIK & LASEK

- A)** 91-8018 Banaji LASIK Irrigation Cannula, 25g
- B)** 91-8019 Bansal LASIK Irrigation Cannula, 25g
- C)** 91-8033 Brown LASEK Epithelial Repositioning Cannula
- D)** 91-8020 Burrato LASIK Irrigation Cannula, 25g
- E)** 91-8028 Dishler LASIK Irrigation Cannula, 30g, 9mm
- 91-8021 Dishler LASIK Irrigation Cannula, 30g, 7mm
- F)** 91-8022 Guell LASIK Irrigation Cannula, 25g

5.11



ELEVATING THE QUALITY



1-800-263-3557

REUSABLE CANNULAS

LASIK & LASEK

5.12

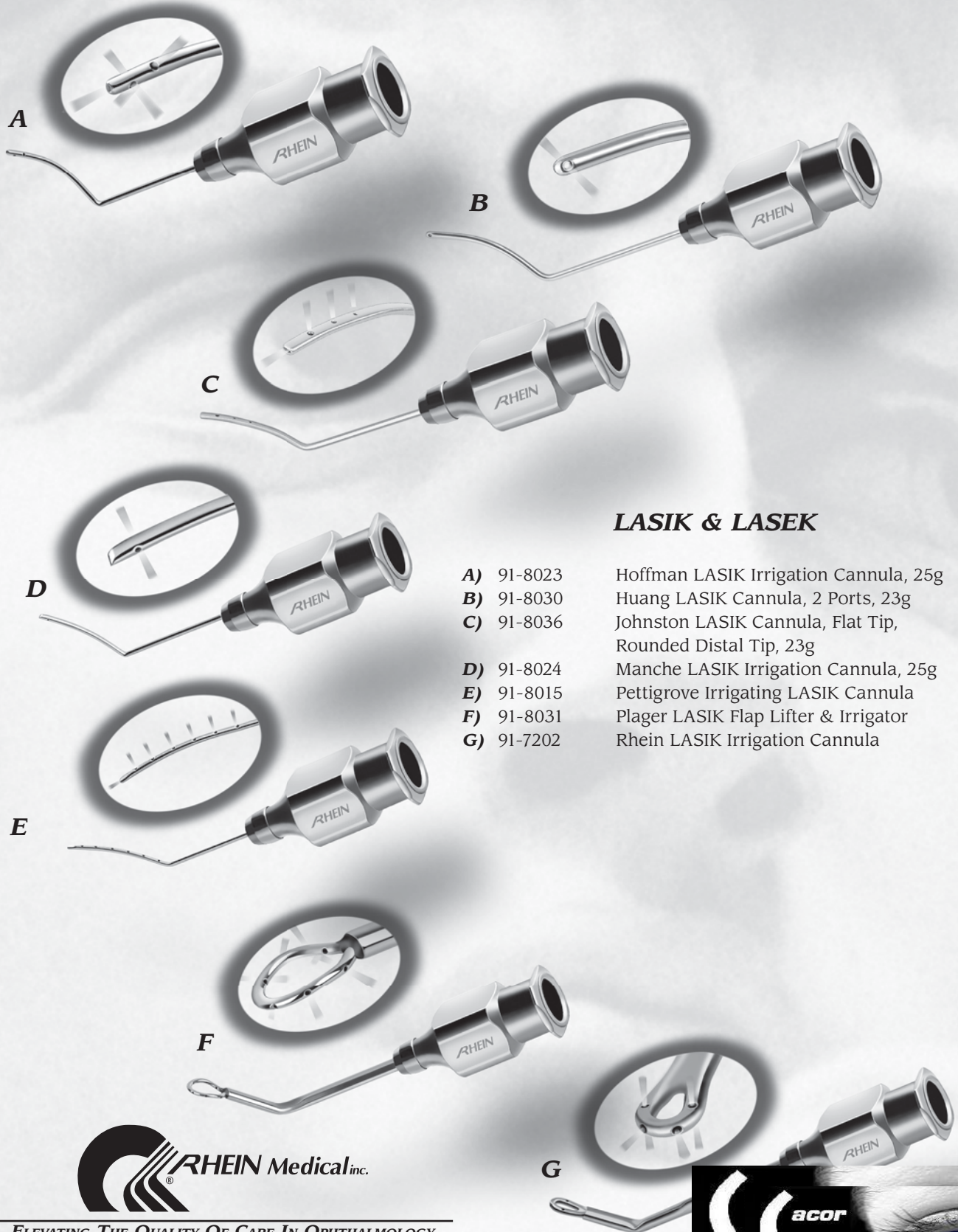

LASIK & LASEK

- A) 91-8023 Hoffman LASIK Irrigation Cannula, 25g
- B) 91-8030 Huang LASIK Cannula, 2 Ports, 23g
- C) 91-8036 Johnston LASIK Cannula, Flat Tip, Rounded Distal Tip, 23g
- D) 91-8024 Manche LASIK Irrigation Cannula, 25g
- E) 91-8015 Pettigrove Irrigating LASIK Cannula
- F) 91-8031 Plager LASIK Flap Lifter & Irrigator
- G) 91-7202 Rhein LASIK Irrigation Cannula



ELEVATING THE QUALITY OF CARE IN OPHTHALMOLOGY
800-637-4346



1-800-263-3557

REUSABLE CANNULAS

LASIK & LASEK

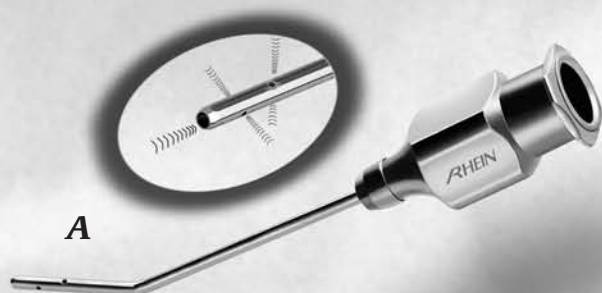

A



B



C



D



E

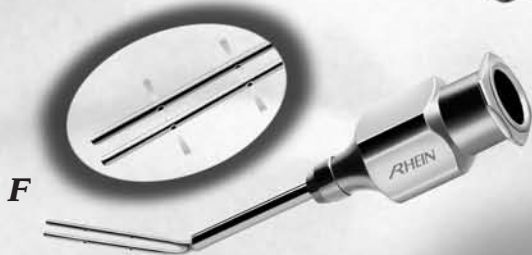

F

LASIK & LASEK

- A)** 91-7204 Rhein LASIK Aspiration Cannula
- B)** 91-8025 Rubenstein LASIK Irrigation Cannula, 23g
- C)** 91-8029-R Seibel LASIK Flap Irrigator & Squeegee, Right Ports
- 91-8029-L Seibel LASIK Flap Irrigator & Squeegee, Left Ports
- D)** 91-8014 Slade LASIK 26g Formed Irrigation Cannula
- E)** 91-8026 Slade LASIK Irrigation Cannula, 27g
- F)** 91-8027 Vidaurri LASIK Irrigation Double Cannula, 25g
- 91-8027-V Vidaurri LASIK Vertical Double LASIK Cannula, 25g

5.13



ELEVATING THE QUALITY



1-800-263-3557

REUSABLE CANNULAS

Miscellaneous

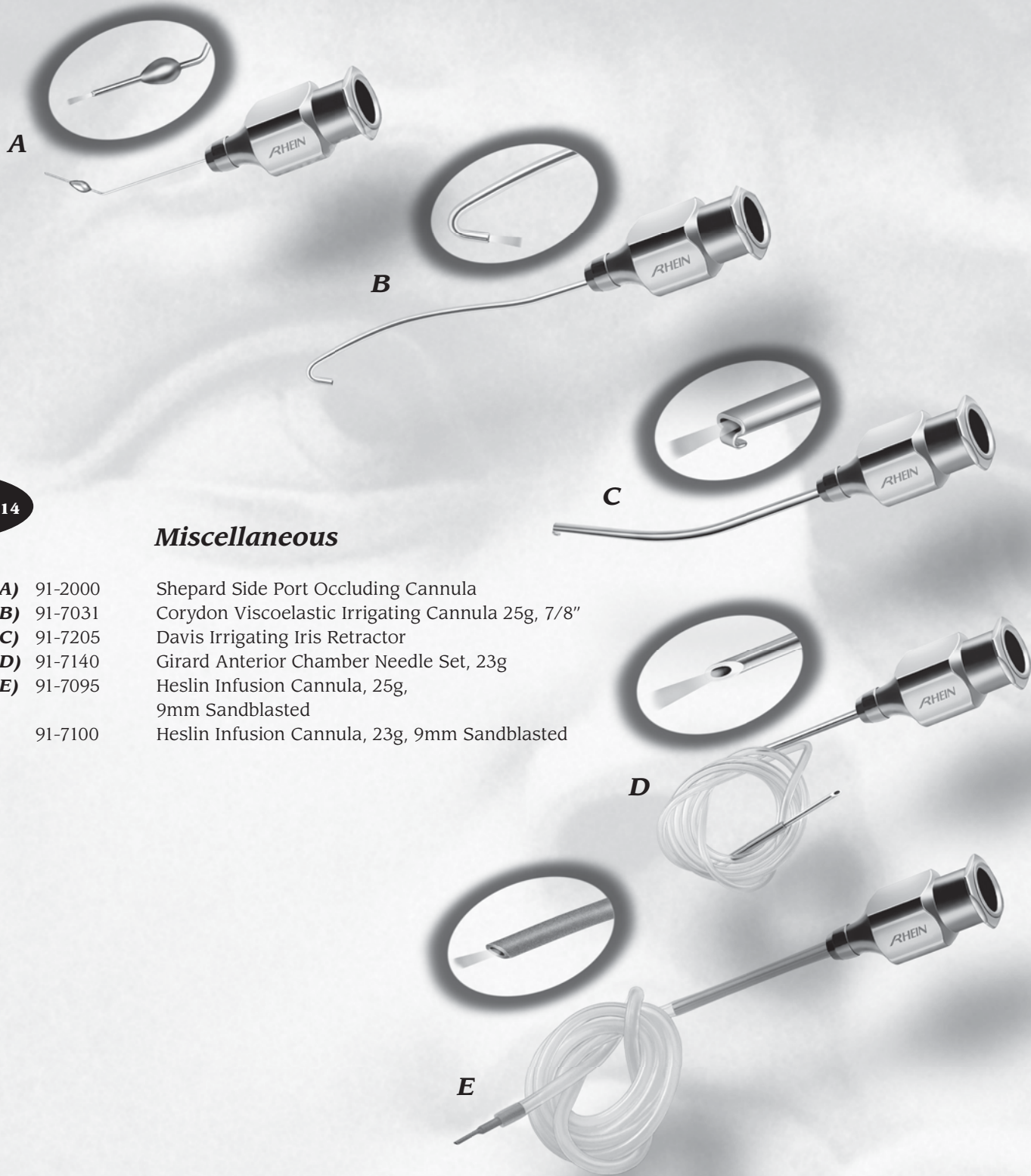

5.14

Miscellaneous

- A) 91-2000 Shepard Side Port Occluding Cannula
- B) 91-7031 Corydon Viscoelastic Irrigating Cannula 25g, 7/8"
- C) 91-7205 Davis Irrigating Iris Retractor
- D) 91-7140 Girard Anterior Chamber Needle Set, 23g
- E) 91-7095 Heslin Infusion Cannula, 25g, 9mm Sandblasted
- 91-7100 Heslin Infusion Cannula, 23g, 9mm Sandblasted



ELEVATING THE QUALITY OF CARE IN OPHTHALMOLOGY
800-637-4346



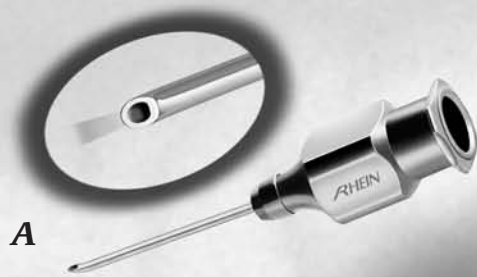

Miscellaneous

- A) 91-7033 Kellan Viscoelastic 21g Cannula
- B) 91-8013 McIntyre III Chamber Maintainer, 19g Tip
- C) 91-7057 Simcoe Nucleus Spatula, 25g, Flattened Tip
- D) 91-7032 Viscoelastic Injection Cannula, 21g, 7mm Tip
- E) 91-7102 Osher Implant Hook, 24g, w/30g Tip

5.15



ELEVATING THE QUALITY



1-800-263-3557

REUSABLE CANNULAS

Retrobulbar, Peribulbar & Subtenon

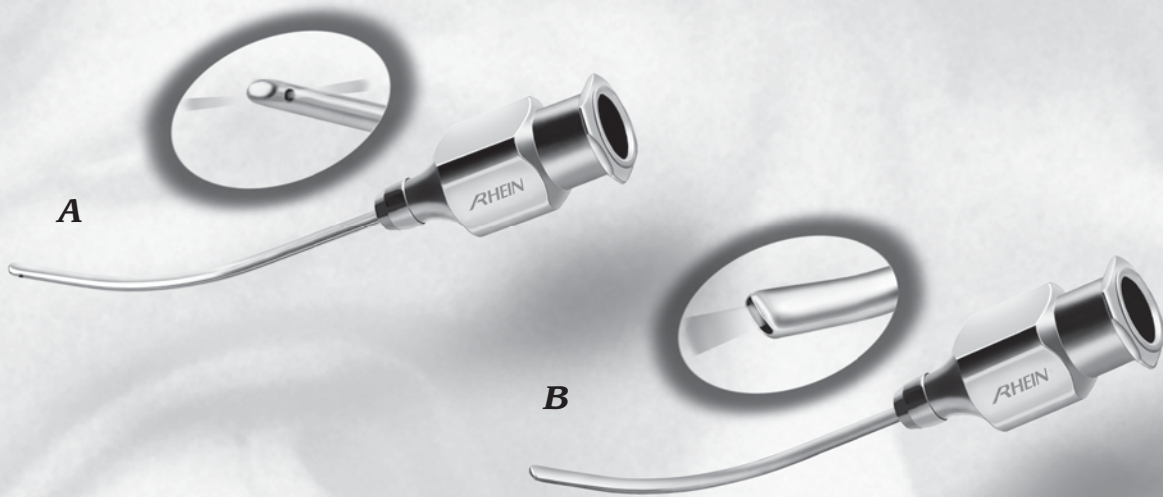

Retrobulbar, Peribulbar & Subtenon

5.16

- A) 91-7078 Masket Sub-Tenon Anesthesia Cannula, 19g
- B) 91-7079 Rhein Open Sub-Tenon Anesthesia Cannula, 19g
- C) 91-7089 Peribulbar, 23g Atkinson, 1"
91-7086 Peribulbar, 23g Atkinson, 5/8"
91-7087 Peribulbar, 23g, Atkinson, 7/8"
91-7088 Peribulbar, 23g, Atkinson, 1-1/4"
- D) 91-7080 Retrobulbar, Atkinson, 23g, 1-1/2" Long
91-7085 Retrobulbar, Atkinson, 25g, 1-1/2" Long



ELEVATING THE QUALITY OF CARE IN OPHTHALMOLOGY
800-637-4346



REUSABLE CANNULAS

Notes

5.17



ELEVATING THE QUALITY



acor

1-800-263-3557



SINGLE-USE CANNULAS & STERILE PRODUCTS

General information

Our cannulas and Autoclaveable Twister protective sheaths are designed to withstand autoclave temperatures. Our Anesthesia Needles are offered sterile in three packaging configurations:

Atkinson Tip Anesthesia Needles-6.01:

Conventional Packaging

Packaged in a standard conventional small-diameter protective sheath within a double-sterile Tyvek pouch. Color-coded label on the inner pouch, visible through the outside pouch.

Twister & Tyvek Packaging

Packaged double-sterile in an easy-to-use Twister sheath with in an outer Tyvek pouch when transfer into a sterile field is required. The color-coded label on the Twister sheath matches the hub color.

Twister Packaging

Packaged single-sterile in an easy-to-use Twister sheath with a color-coded label on the Twister sheath for transfer into a non-sterile field.

Anterior Chamber Cannulas-6.02: Packaged in an easy-to-use Twister sheath, inside a double-sterile Tyvek pouch. Color-coded label on Twister sheath. Tips are angled 45 degrees, 4mm from angle to tip.

Hydrodissectors & "J" Shaped Cannulas-6.02: The distal tips are designed to allow better insertion of cannula into desired position. Packaged in an easy-to-use Twister sheath, inside a double-sterile Tyvek pouch. Color-coded label on Twister sheath. Angled 45 degrees, 9mm from angle to tip. "J" tip only 1.5mm wide, curving 180 degrees back 1.75mm. The unique malleable cannula allows reforming of shape to desired angle or curve for unlimited access around-the-clock.

Cystotomes-6.02: packaged in an easy-to-use Twister sheath, inside a double-sterile Tyvek pouch. Color-coded label on Twister sheath. Precisely shaped, sharp tip. 12mm length of formed section.

Sterile Products-6.03: Instrument Wipes & Diamond Knife Cleaning Blocks, Sterile instrument PVAc wipes designed to gently clean fragile instruments without leaving particulate. Wet fully before use. PVAc cleaning blocks designed to be hydrated for removal of debris on diamond blades.

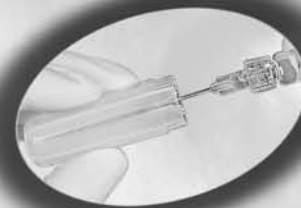
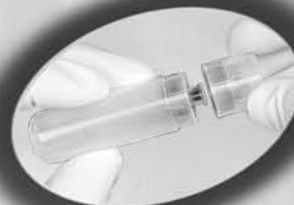

Twister:

These Are Unique Protective User-Friendly Containers. The Needles Are Protected In A Puncture-Proof, Easy-To-Open, Single-Sterile Container That Can Be Comfortably Carried In A Pocket. The Twister Is Also Available In Double-Sterile: A Sterile Twister, Inside A Sterile Tyvek Pouch.



Conventional Small-Diameter Protective Sheaths:

These Needles Are Protected With A Small-Diameter Standard Press-On Sheath, Packaged Double-Sterile Within Two Tyvek Pouches. The Inner Pouch Has A Color-Coded Label Visible Through The Outside Pouch. Available 10 Units Per box. Custom Gauges And Sizes Available Upon Request.

Rhein Medical Universal Color Codes:

- 20 Gauge: Yellow
- 23 Gauge: Blue
- 25 Gauge: Orange
- 27 Gauge: Gray
- 30 Gauge: Colorless



ELEVATING THE QUALITY OF CARE IN OPHTHALMOLOGY
800-637-4346



SINGLE-USE CANNULAS & STERILE PRODUCTS

Retrobulbars & Peribulbars

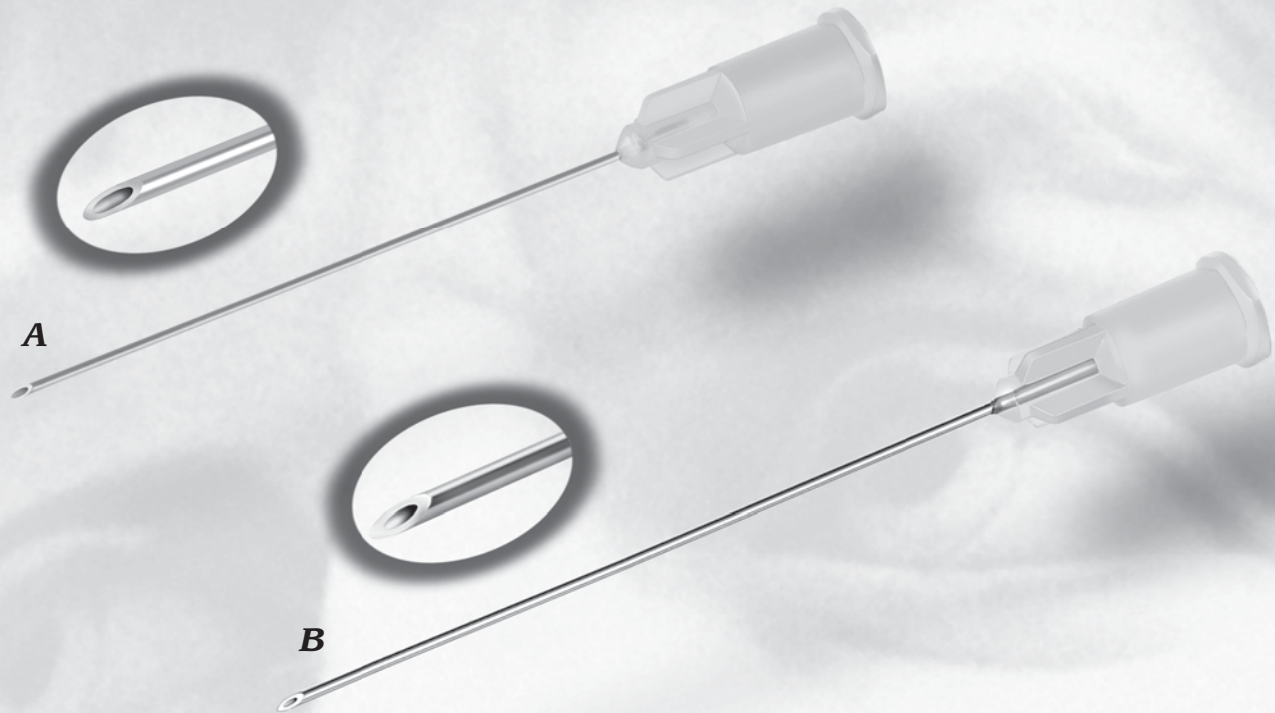

6.01

Peribulbar

A) 07-2023	23g x 1-1/4" Atkinson, Peribulbar, Tyvek-Tyvek, 10/Box
07-2025	25g x 1-1/4" Atkinson, Peribulbar, Tyvek-Tyvek, 10/Box
07-4023	23g x 7/8" Atkinson, Peribulbar, Tyvek-Tyvek, 10/Box
07-4025	25g x 7/8" Atkinson, Peribulbar, Tyvek-Tyvek, 10/Box
09-6520	23g x 7/8" Atkinson, Peribulbar, Twister-Tyvek, 10/Box
09-6521	23g x 1-1/4" Atkinson, Peribulbar, Twister-Tyvek, 10/Box
09-6570	25g x 1-1/4" Atkinson, Peribulbar, Twister-Tyvek, 10/Box
09-6575	25g x 7/8" Atkinson, Peribulbar, Twister-Tyvek, 10/Box
09-6583	23g x 7/8" Atkinson, Peribulbar, Twister, 50/Box
09-6584	23g x 1-1/4" Atkinson, Peribulbar, Twister, 50/Box
09-6585	25g x 7/8" Atkinson, Peribulbar, Twister, 50/Box
09-6586	25g x 1-1/4" Atkinson, Peribulbar, Twister, 50/Box

Retrobulbar

B) 09-6581	23g x 1-1/2" Atkinson, Retrobulbar, Twister, 50/Box
09-6582	25g x 1-1/2" Atkinson, Retrobulbar, Twister, 50/Box
09-6518	25g x 1-1/2" Atkinson, Retrobulbar, Twister-Tyvek, 10/Box
09-6519	23g x 1-1/2" Atkinson, Retrobulbar, Twister-Tyvek, 10/Box
07-1023	23g x 1-1/2" Atkinson Retrobulbar, Tyvek-Tyvek, 10/Box
07-1025	25g x 1-1/2" Atkinson, Retrobulbar, Tyvek-Tyvek, 10/Box



ELEVATING THE QUALITY



1-800-263-3557

SINGLE-USE CANNULAS & STERILE PRODUCTS

Anterior Chamber

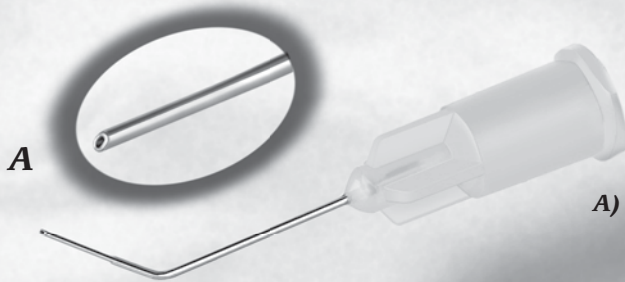

A

- A) 07-5025 25g x 7/8", 45 Degree Angle, 4mm Tip, Twister-Tyvek, 10/Box
- 07-5027 27g x 7/8", 45 Degree Angle, 4mm Tip, Twister-Tyvek, 10/Box
- 07-5030 30g x 7/8", 45 Degree Angle, 4mm Tip, Twister-Tyvek, 10/Box

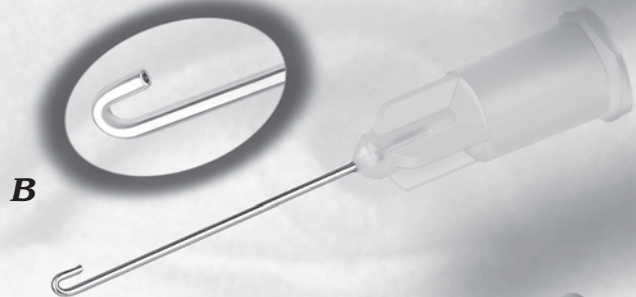

B

- B) 07-5060 25g x 7/8" Micro "J" Shaped Cannula, Malleable Shaft, 10/Box
- 07-5125 25g x 7/8", Flexible Straight Cannula, Twister-Tyvek, 10/Box

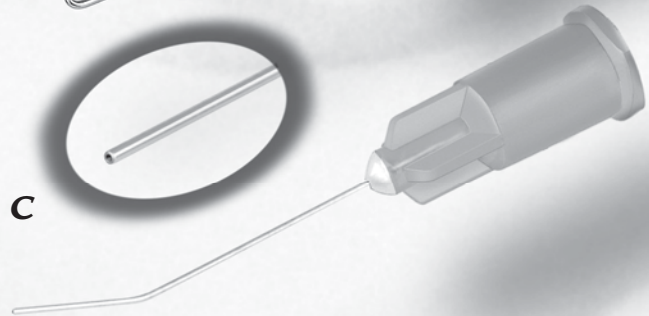

C

- C) 09-6514 27g x 7/8", Straight Cannula 45 Degree Tip, Twister-Tyvek, 10/Box

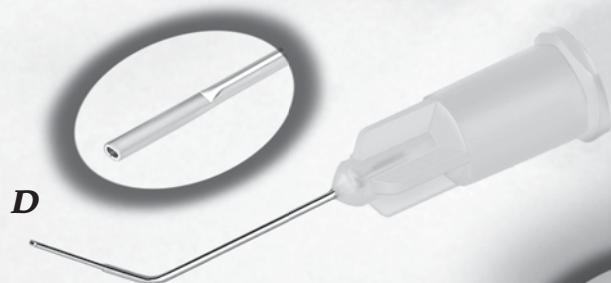

D

- D) 07-6025 25g x 7/8" Hydrodissector, 45 Degree, 9mm, Flat Tip, Twister-Tyvek, 10/Box
- 07-6027 27g x 7/8" Hydrodissector, 45 Degree, 9mm, Flat Tip, Twister-Tyvek, 10/Box
- 07-6030 30g x 7/8" Hydrodissector, 45 Degree, 9mm, Flat Tip, Twister-Tyvek, 10/Box



E

- E) 07-3025 25g x 5/8" Irrigating Cystotome, Formed, 10/Box
- 07-3027 27g x 5/8" Irrigating Cystotome, Formed, 10/Box
- 07-3030 30g x 5/8" Irrigating Cystotome, Formed, 10/Box

Anterior Chamber

Hydrodissector

Cystotome

6.02



ELEVATING THE QUALITY OF CARE IN OPHTHALMOLOGY
800-637-4346



1-800-263-3557

SINGLE-USE CANNULAS & STERILE PRODUCTS

Disposable Sterile Products

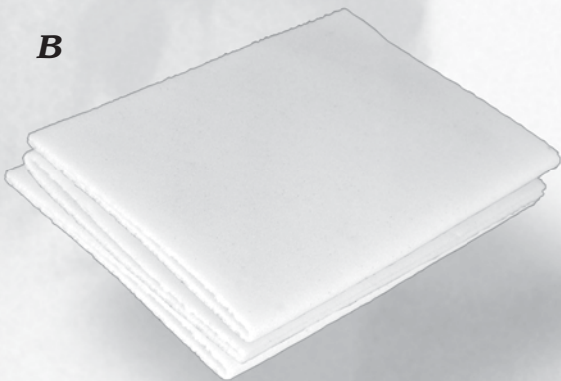
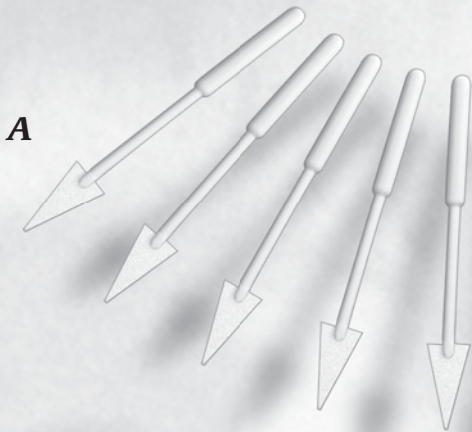

Disposable Sterile Products

- | | |
|-------------------|---------------------------------------|
| A) 09-7001 | Cellulose Eye Spears, 100/Box |
| B) 09-7010 | PVAc Instrument Wipes, 30/Box |
| C) 09-7015 | Diamond Knife Cleaning Blocks, 10/Box |

6.03



ELEVATING THE QUALITY



1-800-263-3557



CHOPPERS, NON-IRRIGATING

- *Stainless & Titanium-7.01*
- *Double Ended Choppers-7.06*

General Information:

Most choppers are available in either stainless steel, or titanium. Most have mirror polished distal tips to protect the posterior capsule. Care should be used when inserting and removing the choppers through the paracentesis. Generally, they should be angled into and out of the incision.

Choppers Are Designed To:

1. Be placed near the edge of the anterior capsule and dragged through the nucleus toward the phaco incision;
2. Be placed near the edge of the anterior capsule and dragged through the nucleus toward the paracentesis;
3. Be placed centrally on top of the nucleus and pressed posteriorly to "quick chop" the nucleus;
4. Be placed centrally underneath the fractured nucleus to "back crack" the nucleus from posterior to anterior.
5. Some of our choppers can be used in either hand, and some are subordinate-hand specific, meaning you can only use them in your subordinate hand. Please contact our customer service staff for assistance in selecting the chopper which is best suited to your surgical technique.

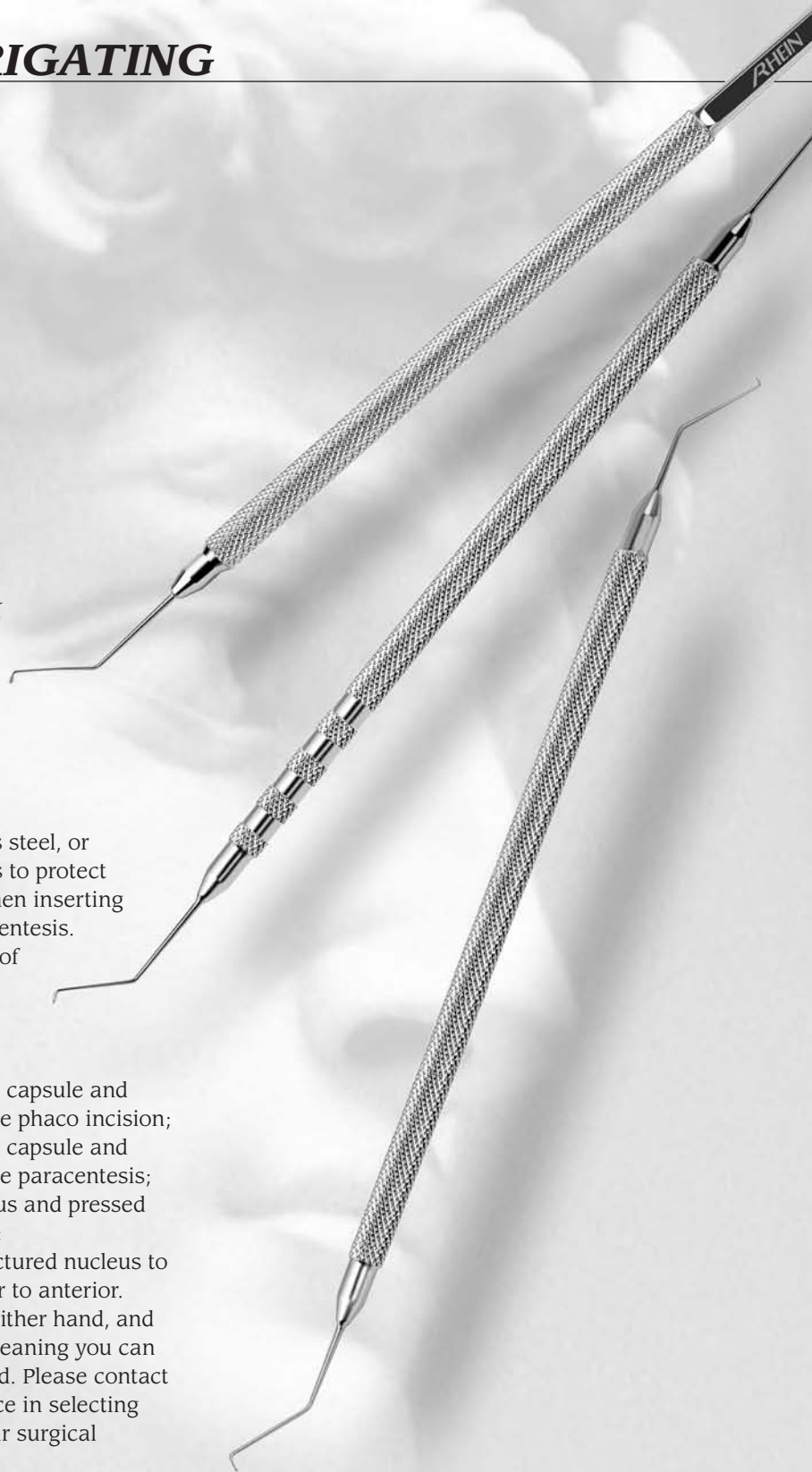

7.00



ELEVATING THE QUALITY OF CARE IN OPHTHALMOLOGY
800-637-4346



CHOPPERS, NON-IRRIGATING

Stainless & Titanium

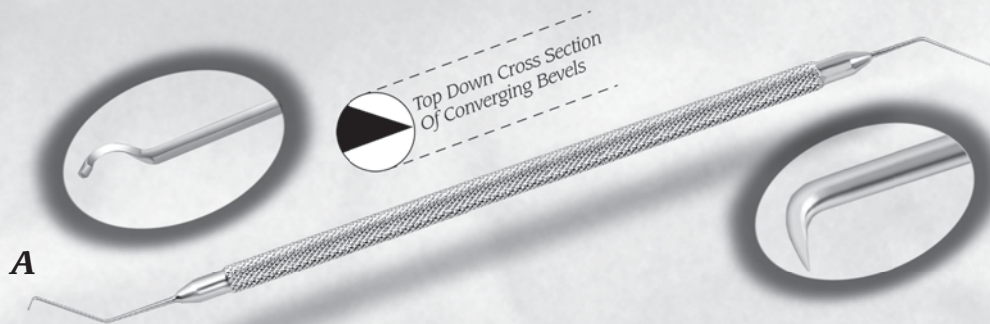

A

Top Down Cross Section
Of Converging Bevels

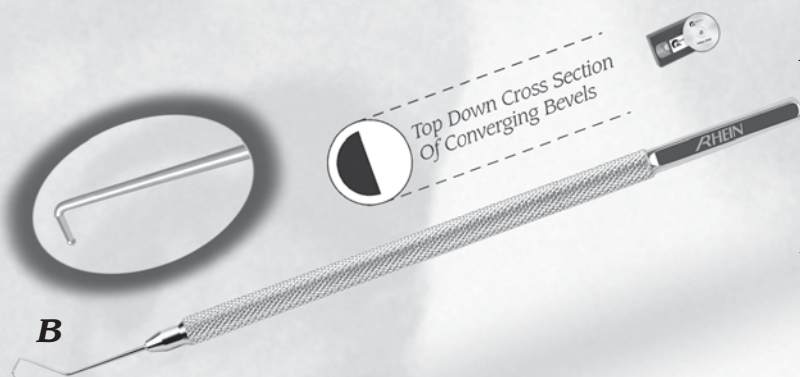

B

Top Down Cross Section
Of Converging Bevels

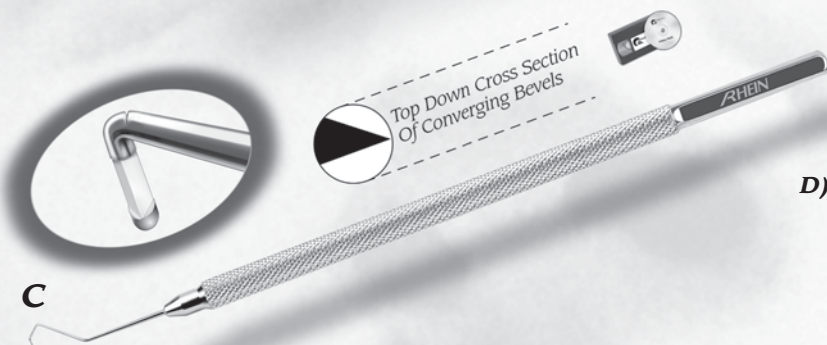

C

Top Down Cross Section
Of Converging Bevels

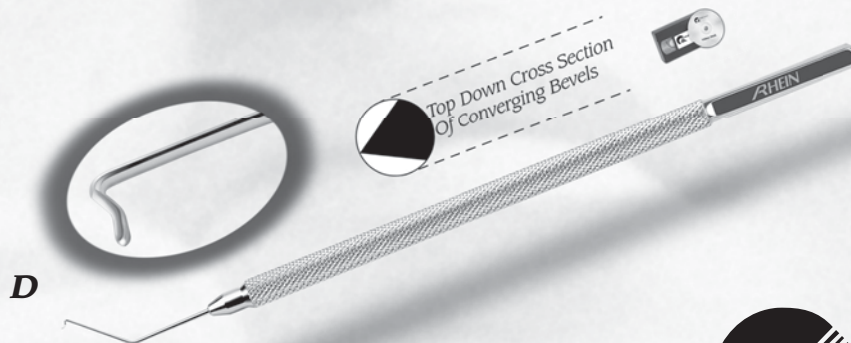

D

Top Down Cross Section
Of Converging Bevels

Stainless & Titanium

- | | | |
|-----------|-----------|---|
| A) | 8-14562-R | Chang Chopper, 1.75mm Tip, Double Ended w/Pick, Right Hand Dominant Surgeon |
| | 8-14562-L | Chang Chopper, 1.75mm Tip, Double Ended w/Pick, Left Hand Dominant Surgeon |
| B) | 8-14505 | Davidoff Ambidextrous Nucleus Chopper |
| | 05-4037 | Davidoff Ambidextrous Nucleus Chopper-Titanium |
| C) | 8-14503-L | Fine-Nagahara Phaco Chopper, Left Hand Dominant |
| | 05-4036-L | Fine-Nagahara Phaco Chopper, Left Hand Dominant-Titanium |
| | 8-14503-R | Fine-Nagahara Phaco Chopper, Right Hand Dominant |
| | 05-4036 | Fine-Nagahara Phaco Chopper, Right Hand Dominant-Titanium |
| D) | 8-14511 | Gillum Phaco Splitter |

7.01



ELEVATING THE QUALITY



1-800-263-3557



CHOPPERS, NON-IRRIGATING

Stainless & Titanium

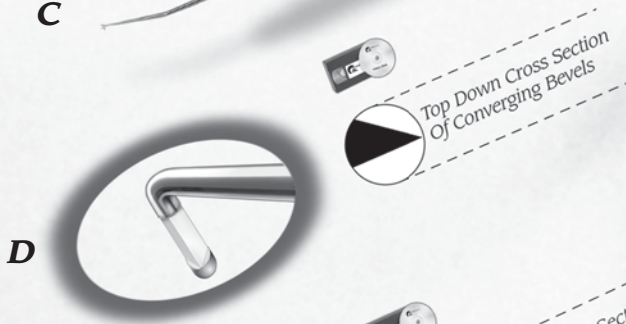
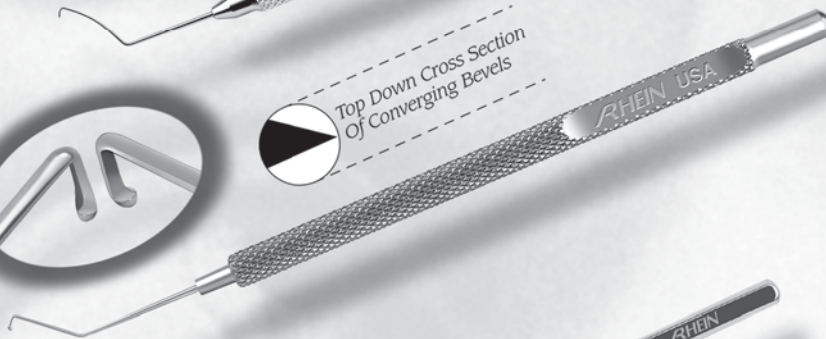
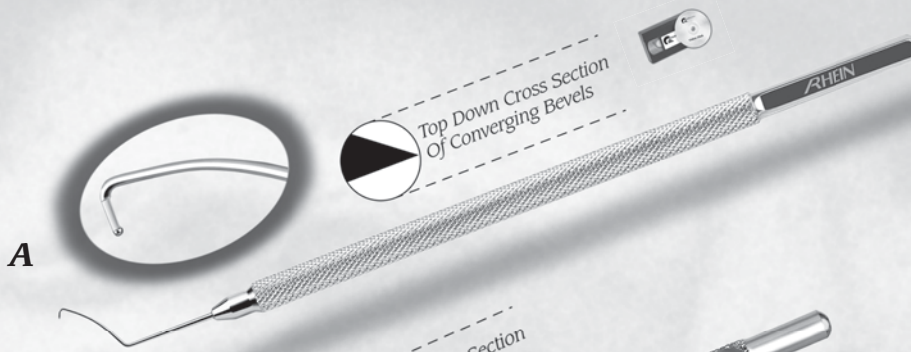

Stainless & Titanium

- A)** 8-14512 Gillum Side Port Splitter-Right Hand Dominant Surgeon
- 8-14512-L Gillum Side Port Splitter-Left Hand Dominant Surgeon
- B)** 05-4034-R He Hook Chopper - Right Handed Surgeon-Titanium
- 05-4034-L He Hook Chopper - Left Handed Surgeon-Titanium
- C)** 8-14508 Lindstrom Trident Splitter - Right Hand Dominant
- 8-14508-L Lindstrom Trident Splitter - Left Hand Dominant
- D)** 8-14502 Nagahara Phaco Chopper, Right Hand Dominant
- 8-14502-L Nagahara Phaco Chopper, Left Hand Dominant
- 05-4035-L Nagahara Phaco Chopper, Left Hand Dominant-Titanium
- 05-4035 Nagahara Phaco Chopper, Right Hand Dominant-Titanium
- E)** 8-14530 Nichamin I Quick Chopper-Right Hand Dominant
- 8-14530-L Nichamin I Quick Chopper-Left Hand Dominant

7.02



ELEVATING THE QUALITY OF CARE IN OPHTHALMOLOGY
800-637-4346



CHOPPERS, NON-IRRIGATING

Stainless & Titanium

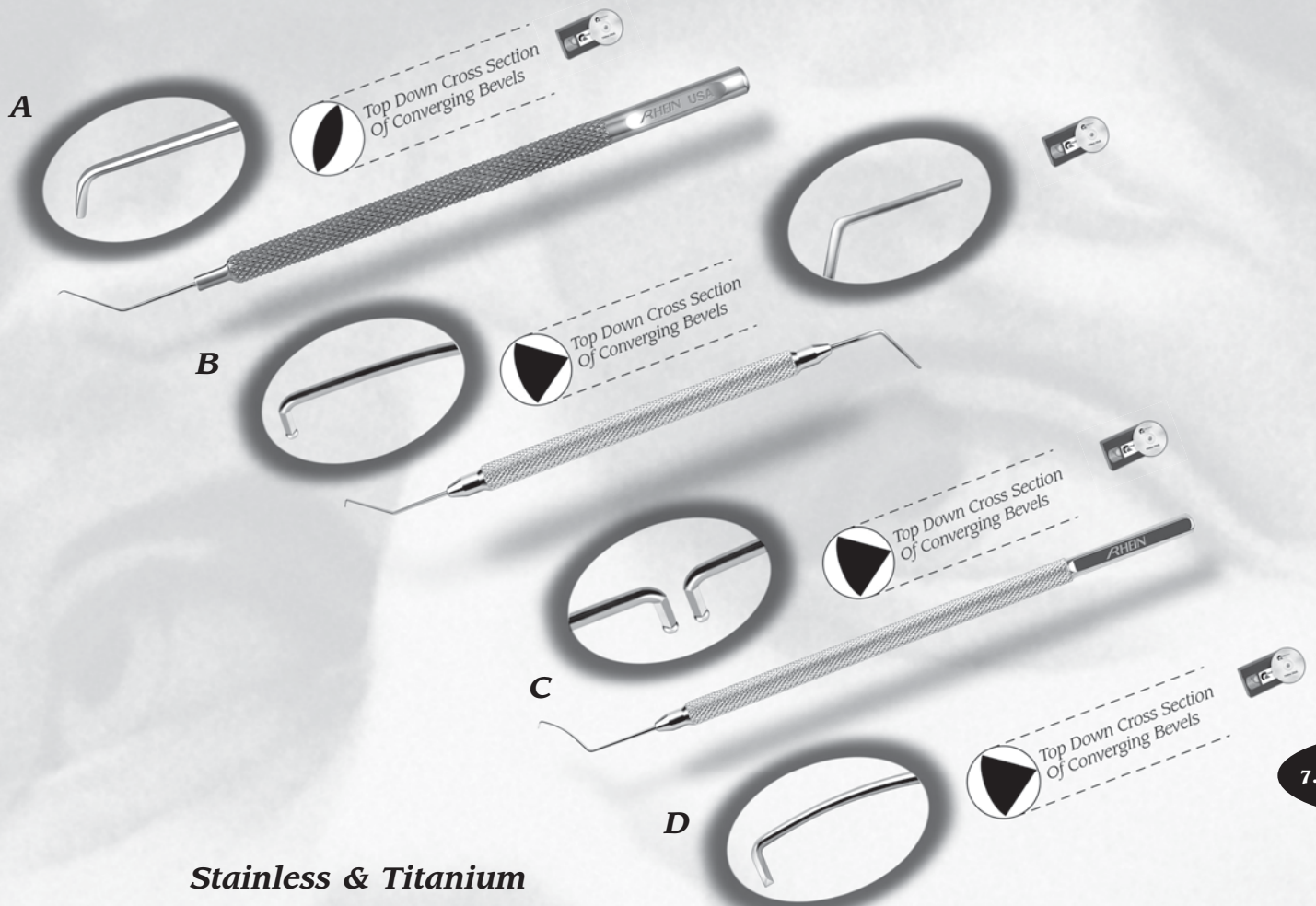

7.03

Stainless & Titanium

- A)** 05-4043 Nichamin Quick Chopper-Right Hand Dominant-Titanium
- 05-4043-L Nichamin Quick Chopper-Left Hand Dominant-Titanium
- 8-14533-R Nichamin II Quick Chopper, Right Hand Dominant Surgeon
- 8-14533-L Nichamin II Quick Chopper, Left Hand Dominant Surgeon
- B)** 8-14509 Nichamin Triple Chopper w/Spatula
- C)** 8-14506 Nichamin Triple Nucleus Chopper
- 05-4038 Nichamin Triple Nucleus Chopper-Titanium
- D)** 8-14521 Nichamin Vertical Nucleus Chopper
- 05-4042 Nichamin Vertical Nucleus Chopper-Titanium
- E)** 8-14558 Rhein Quick Pick Chopper, Non-Irrigating
- F)** 8-14559 Nichamin Formed Quick Pick Chopper, Non-Irrigating



CHOPPERS, NON-IRRIGATING

Stainless & Titanium

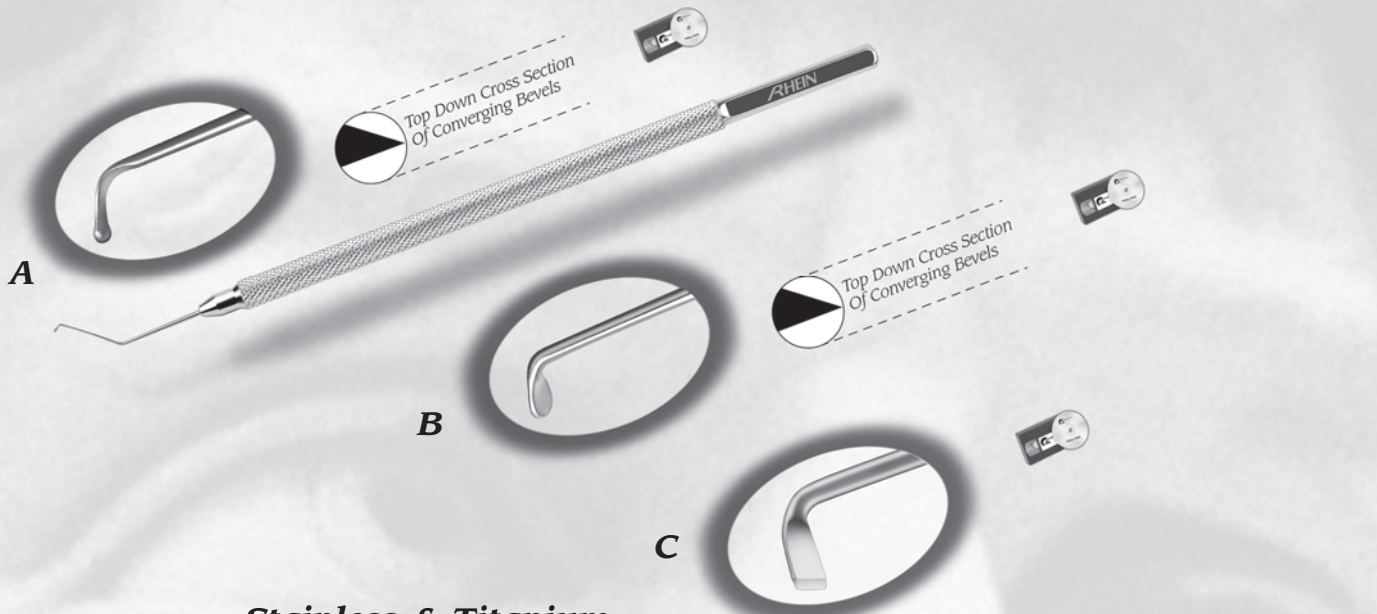

Stainless & Titanium

- A)** 8-14516 Seibel Nucleus Chopper-Right Hand Dominant, Angled
- 05-4040 Seibel Nucleus Chopper, Angled-Right Hand Dominant Surgeon-Titanium
- 8-14516-L Seibel Nucleus Chopper-Left Hand Dominant, Angled
- 05-4040-L Seibel Nucleus Chopper, Angled-Left Hand Dominant Surgeon-Titanium
- 8-14516-SL Seibel Nucleus Chopper-Left Hand Dominant, Straight
- 05-4040-SL Seibel Nucleus Chopper, Straight-Left Hand Dominant Surgeon-Titanium
- B)** 8-14535-R Seibel Vertical Safety Quick Chopper, Right Hand Dominant
- 8-14516-S Seibel Nucleus Chopper-Right Hand Dominant, Straight
- 05-4040-S Seibel Nucleus Chopper, Straight-Right Hand Dominant Surgeon-Titanium
- 8-14535-L Seibel Vertical Safety Quick Chopper, Left Hand Dominant
- 05-4064-L Seibel Vertical Safety Quick Chopper, Left Hand Dominant, Titanium
- 05-4064-R Seibel Vertical Safety Quick Chopper, Right Hand Dominant, Titanium
- C)** 8-14527 Shepherd Tomahawk Chopper-Right Hand Dominant
- 8-14527-L Shepherd Tomahawk Chopper-Left Hand Dominant
- 05-4045-L Shepherd Tomahawk Chopper-Left Hand Dominant-Titanium
- 05-4045 Shepherd Tomahawk Chopper-Right Hand Dominant-Titanium
- D)** 8-14504 Steinert I Claw Chopper
- E)** 8-14507 Steinert II Claw Chopper
- 05-4039 Steinert II Claw Chopper-Titanium

7.04



ELEVATING THE QUALITY OF CARE IN OPHTHALMOLOGY
800-637-4346



1-800-263-3557

CHOPPERS, NON-IRRIGATING

Stainless & Titanium

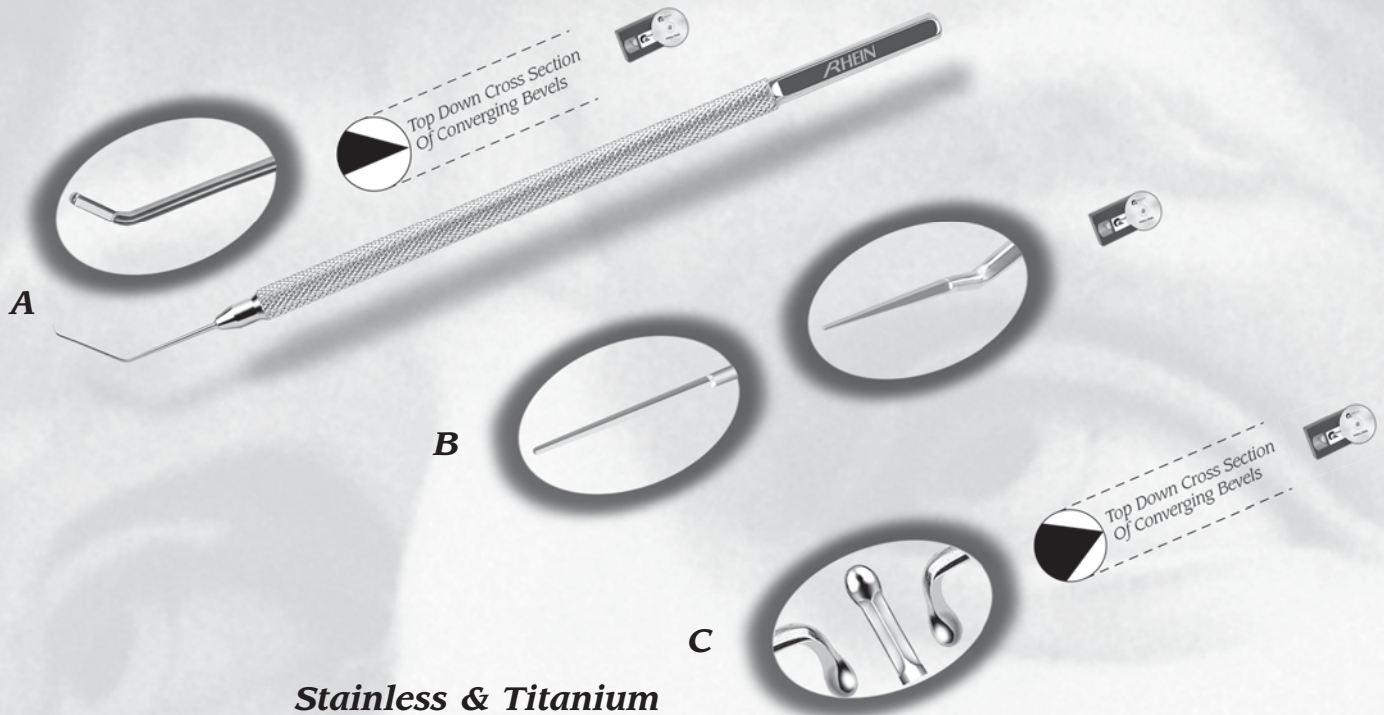

Stainless & Titanium

- A)** 8-14526 Sung Reverse Nucleus Chopper-Right Hand Dominant Surgeon
- 8-14526-L Sung Reverse Nucleus Chopper-Left Hand Dominant Surgeon
- 05-4044-L Sung Reverse Nucleus Chopper-Left Hand Dominant Surgeon-Titanium
- 05-4044 Sung Reverse Nucleus Chopper-Right Hand Dominant Surgeon-Titanium
- B)** 8-14561 Toyos Aqua-Chopper
- C)** 8-14539 Verges Phaco Chopper
- 05-4067 Verges Phaco Chopper-Titanium
- D)** 8-14528-L Winter Helping Hand Chopper - Left Curve
- 05-4047-L Winter Helping Hand Chopper - Left Curve-Titanium
- E)** 8-14528-R Winter Helping Hand Chopper - Right Curve
- 05-4047 Winter Helping Hand Chopper - Right Curve-Titanium

7.05



ELEVATING THE QUALITY



1-800-263-3557



CHOPPERS, NON-IRRIGATING

Double Ended Choppers



7.06

Double Ended Choppers

- A)** 8-14537-R Fine-Nichamin Quick I Double Chopper Right Hand Dominant
 8-14537-L Fine-Nichamin Quick I Double Chopper Left Hand Dominant
 05-4066-L Fine-Nichamin Quick I Double Chopper Left Hand Dominant
 05-4066-R Fine-Nichamin Quick I Double Chopper Right Hand Dominant
- B)** 8-14531 Nichamin I Quick Chopper & Nucleus Pick-Right Hand Dominant

- 8-14531-L Nichamin I Quick Chopper & Nucleus Pick-Left Hand Dominant
 05-4057-L Nichamin I Quick Chopper & Nucleus Pick-Left Hand Dominant-Titanium
 05-4057 Nichamin I Quick Chopper & Nucleus Pick-Right Hand Dominant-Titanium
C) 8-14532 Nichamin Triple Chopper & Quick I Chopper-Right Hand Dominant
 8-14532-L Nichamin Triple Chopper & Quick I Chopper-Left Hand Dominant
 05-4058-L Nichamin Triple Chopper & Quick I Chopper-Left Hand Dominant-Titanium
 05-4058 Nichamin Triple Chopper & Quick I Chopper-Right Hand Dominant-Titanium



ELEVATING THE QUALITY OF CARE IN OPHTHALMOLOGY
 800-637-4346



1-800-263-3557

CHOPPERS, NON-IRRIGATING

Double Ended Choppers

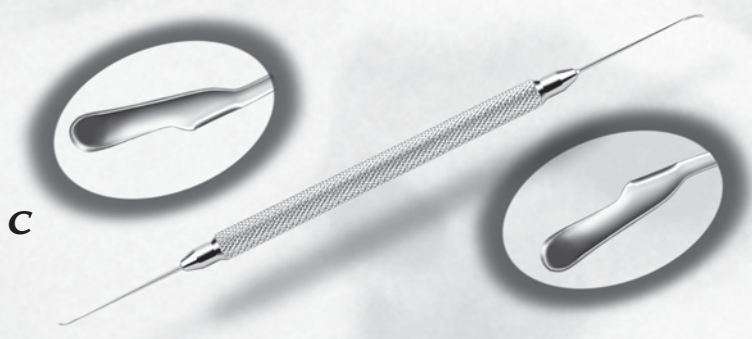
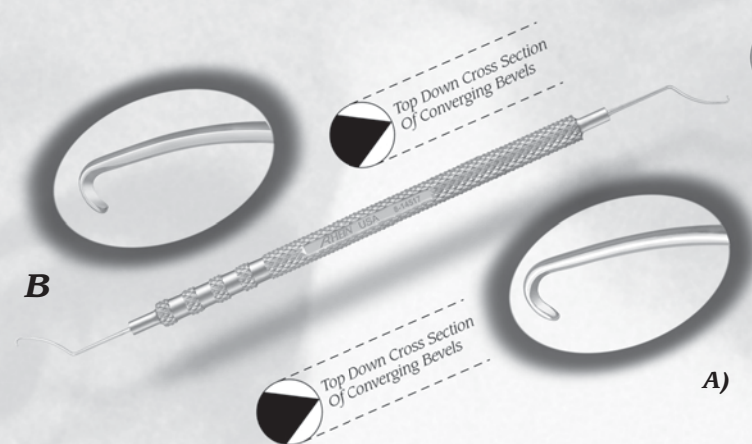
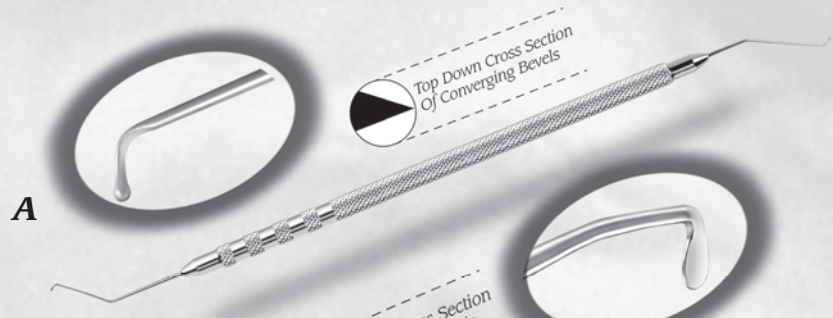

Double Ended Choppers

- A)** 8-14536-R Seibel Nucleus Chopper & Safety Quick Chopper, Right Hand Dominant
- 05-4065-R Seibel Nucleus Chopper & Safety Quick Chopper, Right Hand Dominant, Titanium
- 8-14536-L Seibel Nucleus Chopper & Safety Quick Chopper, Left Hand Dominant
- 05-4065-L Seibel Nucleus Chopper & Safety Quick Chopper, Left Hand Dominant, Titanium
- B)** 8-14517 Steinert III Double-Ended Claw Chopper
- 05-4041 Steinert III Double-Ended Claw Chopper-Titanium
- C)** 8-14528 Winter Helping Hand Chopper - Double Ended
- 05-4046 Winter Helping Hand Chopper - Double Ended-Titanium

7.07



ELEVATING THE QUALITY

ACOR

1-800-263-3557



CHOPPERS, IRRIGATING



8.00

- *Dual Port & Open Ended*



ELEVATING THE QUALITY OF CARE IN OPHTHALMOLOGY
800-637-4346



1-800-263-3557

CHOPPERS, IRRIGATING

Dual Port & Open Ended



Dual Port & Open Ended

- A)** 8-14542 Fine 20g Irrigating Reverse Actuating Splitting Chopper, 1.4mm Incision
- 8-14543 Fine 22g Irrigating Reverse Actuating Splitting Chopper, 1.1mm Incision
- B)** 8-14549 Fine Wedge 20g Irrigating Chopper w/ Open Ended Irrigation, 1.4mm Incision
- C)** 8-14557 Gillum Open-Ended Irrigating Phaco Splitter On A Handpiece
- D)** 8-14502-LI Nagahara 20g Dual Port Irrigating Phaco Chopper, Left Hand Dominant
- 8-14502-I Nagahara 20g Dual Port Irrigating Phaco Chopper, Right Hand Dominant
- E)** 8-14546 Nagahara 20g Irrigating Chopper w/ Open Ended Irrigation, 1.4mm Incision
- F)** 8-14530-LI Nichamin 20g Dual Port Irrigating I Quick Chopper-Left Hand Dominant
- 8-14530-I Nichamin 20g Dual Port Irrigating I Quick Chopper-Right Hand Dominant

B

C

D

E

F

8.01



ELEVATING THE QUALITY



1-800-263-3557



CHOPPERS, IRRIGATING

Dual Port & Open Ended

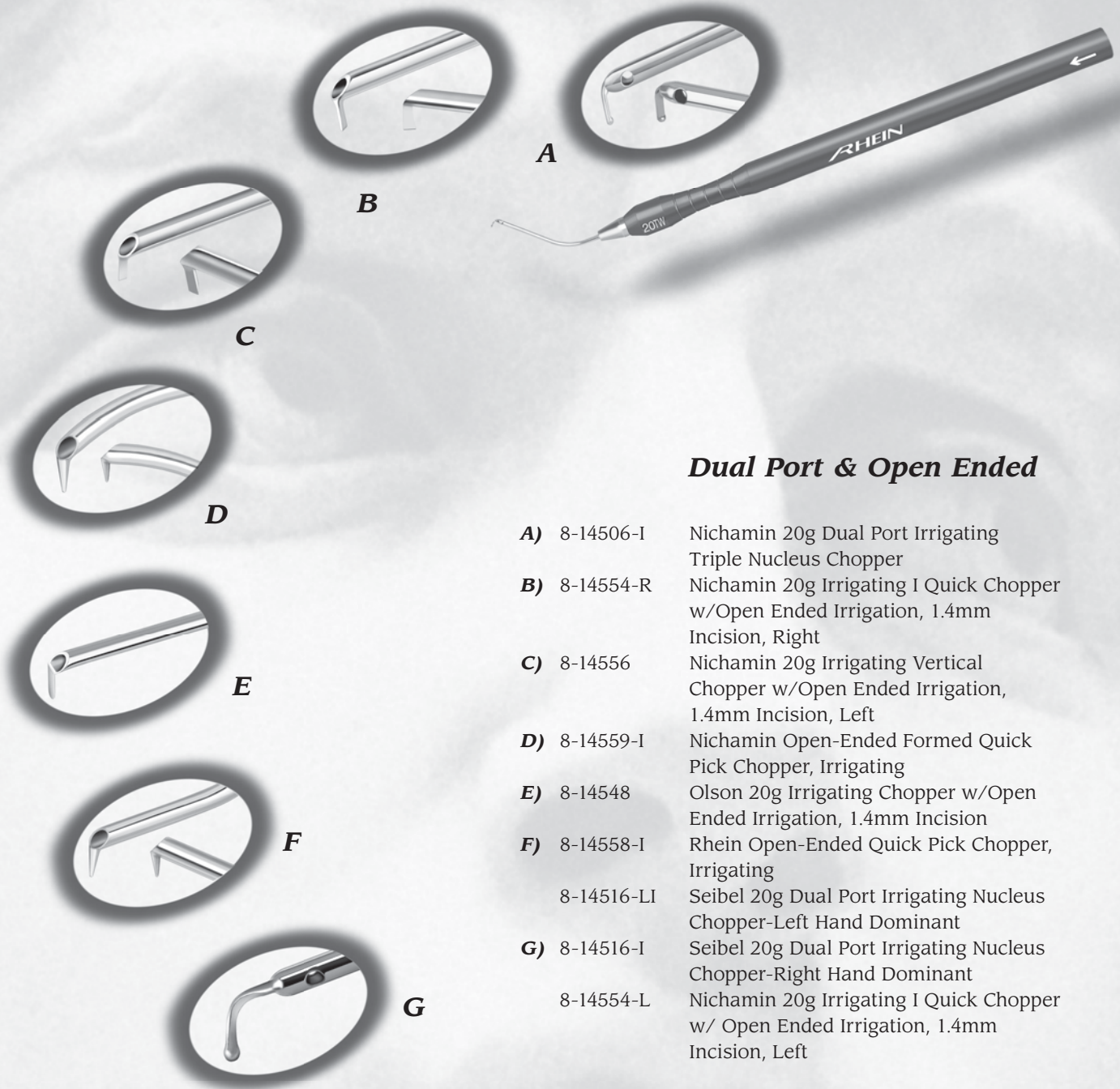

Dual Port & Open Ended

- A) 8-14506-I Nichamin 20g Dual Port Irrigating Triple Nucleus Chopper
- B) 8-14554-R Nichamin 20g Irrigating I Quick Chopper w/Open Ended Irrigation, 1.4mm Incision, Right
- C) 8-14556 Nichamin 20g Irrigating Vertical Chopper w/Open Ended Irrigation, 1.4mm Incision, Left
- D) 8-14559-I Nichamin Open-Ended Formed Quick Pick Chopper, Irrigating
- E) 8-14548 Olson 20g Irrigating Chopper w/Open Ended Irrigation, 1.4mm Incision
- F) 8-14558-I Rhein Open-Ended Quick Pick Chopper, Irrigating
- 8-14516-LI Seibel 20g Dual Port Irrigating Nucleus Chopper-Left Hand Dominant
- G) 8-14516-I Seibel 20g Dual Port Irrigating Nucleus Chopper-Right Hand Dominant
- 8-14554-L Nichamin 20g Irrigating I Quick Chopper w/ Open Ended Irrigation, 1.4mm Incision, Left

8.02



ELEVATING THE QUALITY OF CARE IN OPHTHALMOLOGY
800-637-4346



1-800-263-3557

CHOPPERS, IRRIGATING

Dual Port & Open Ended



A

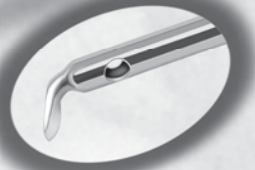

B



C



Dual Port & Open Ended

- A)** 8-14535-RI Seibel 20g Dual Port Irrigating Vertical Safety Quick Chopper, Right Hand Dominant
- 8-14535-LI Seibel 20g Dual Port Irrigating Vertical Safety Quick Chopper, Left Hand Dominant
- B)** 8-14553-R Seibel 20g Irrigating Safety Chopper w/ Open Ended Irrigation, 1.4mm Incision, Right
- 8-14553-L Seibel 20g Irrigating Safety Chopper w/ Open Ended Irrigation, 1.4mm Incision, Left
- C)** 8-14555-R Shepherd 20g Irrigating Tomahawk Chopper w/Open Ended Irrigation, 1.4mm Incision, Right
- 8-14555-L Shepherd 20g Irrigating Tomahawk Chopper w/Open Ended Irrigation, 1.4mm Incision, Left
- D)** 8-14507-I Steinert II 20g Dual Port Irrigating Claw Chopper
- E)** 8-14547 Tsuneoka 20g Irrigating Chopper w/ Open Ended Irrigation, 1.4mm Incision
- F)** 8-14539-I Verges 20g Irrigating Phaco Chopper w/ Open Ended Port, 1.4mm Incision

D



E



F



8.03



ELEVATING THE QUALITY



1-800-263-3557



SPATULAS



9.00



ELEVATING THE QUALITY OF CARE IN OPHTHALMOLOGY
800-637-4346



1-800-263-3557

SPATULAS

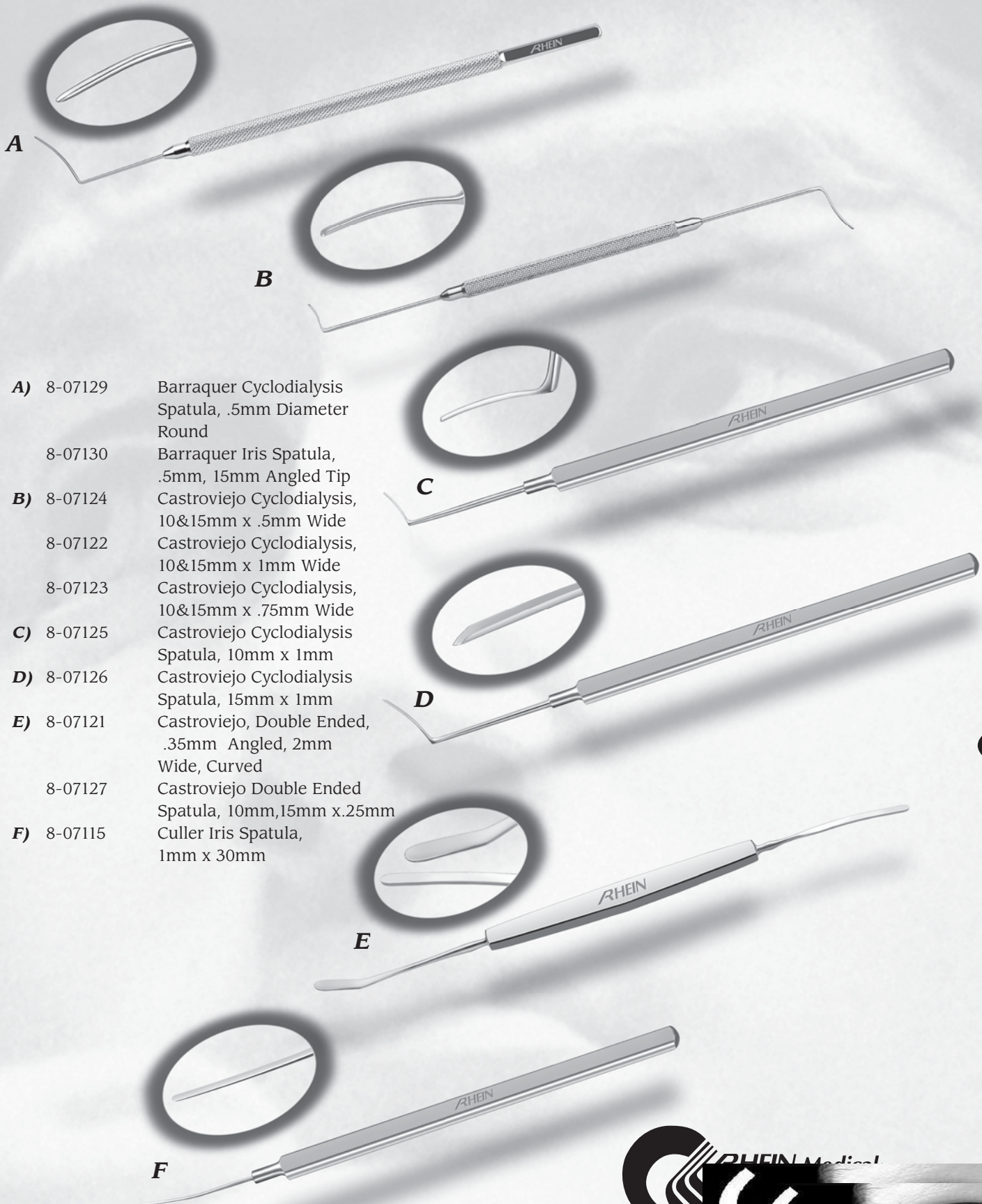

- A)** 8-07129 Barraquer Cyclodialysis Spatula, .5mm Diameter Round
- 8-07130 Barraquer Iris Spatula, .5mm, 15mm Angled Tip
- B)** 8-07124 Castroviejo Cyclodialysis, 10&15mm x .5mm Wide
- 8-07122 Castroviejo Cyclodialysis, 10&15mm x 1mm Wide
- 8-07123 Castroviejo Cyclodialysis, 10&15mm x .75mm Wide
- C)** 8-07125 Castroviejo Cyclodialysis Spatula, 10mm x 1mm
- D)** 8-07126 Castroviejo Cyclodialysis Spatula, 15mm x 1mm
- E)** 8-07121 Castroviejo, Double Ended, .35mm Angled, 2mm Wide, Curved
- 8-07127 Castroviejo Double Ended Spatula, 10mm,15mm x.25mm
- F)** 8-07115 Culler Iris Spatula, 1mm x 30mm

9.01



RHEIN Medical

ELEVATING THE QUALITY



ACOR



1-800-263-3557

SPATULAS

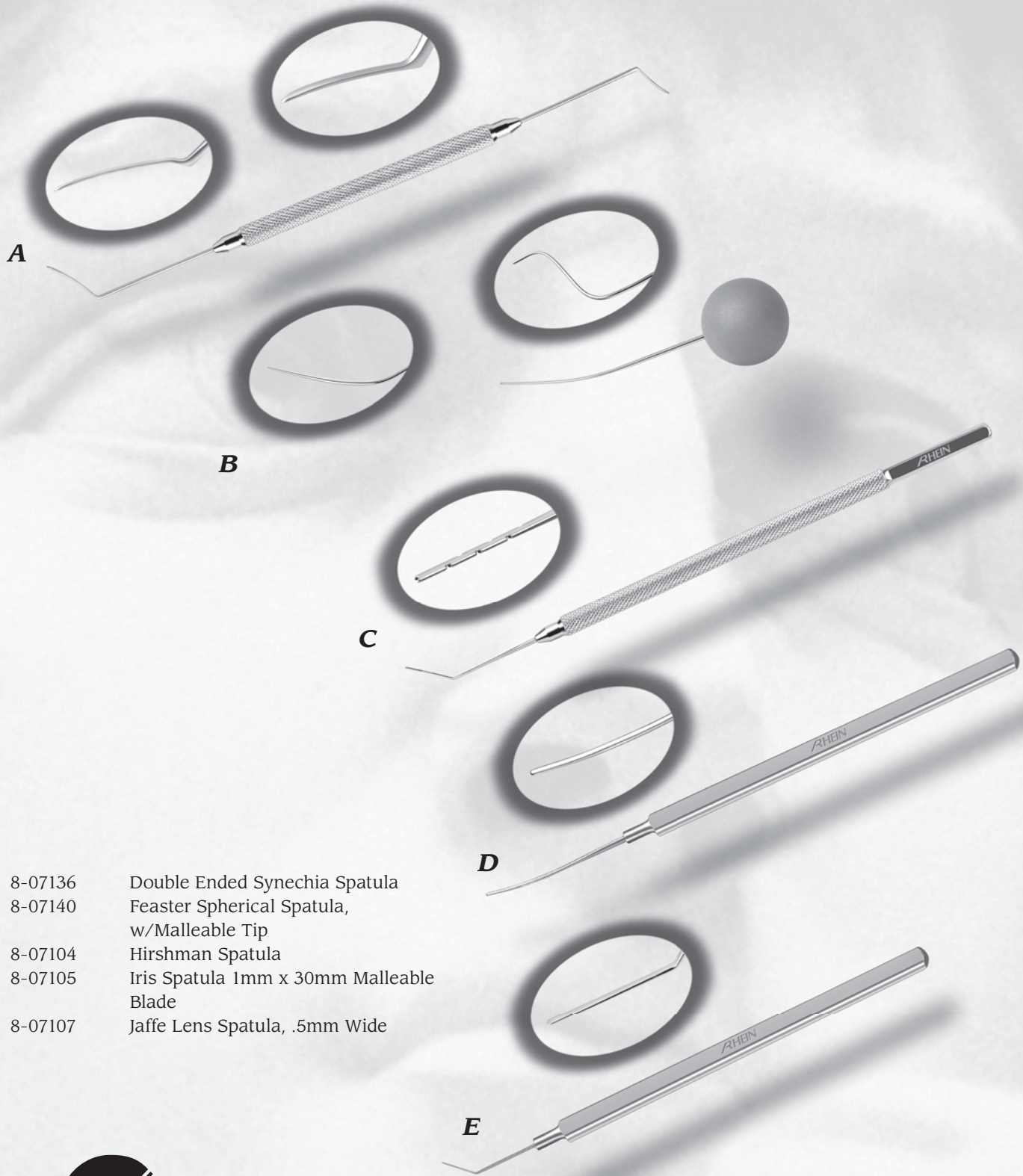

9.02

- A) 8-07136 Double Ended Synechia Spatula
- B) 8-07140 Feaster Spherical Spatula, w/Malleable Tip
- C) 8-07104 Hirshman Spatula
- D) 8-07105 Iris Spatula 1mm x 30mm Malleable Blade
- E) 8-07107 Jaffe Lens Spatula, .5mm Wide



ELEVATING THE QUALITY OF CARE IN OPHTHALMOLOGY
800-637-4346



1-800-263-3557

SPATULAS

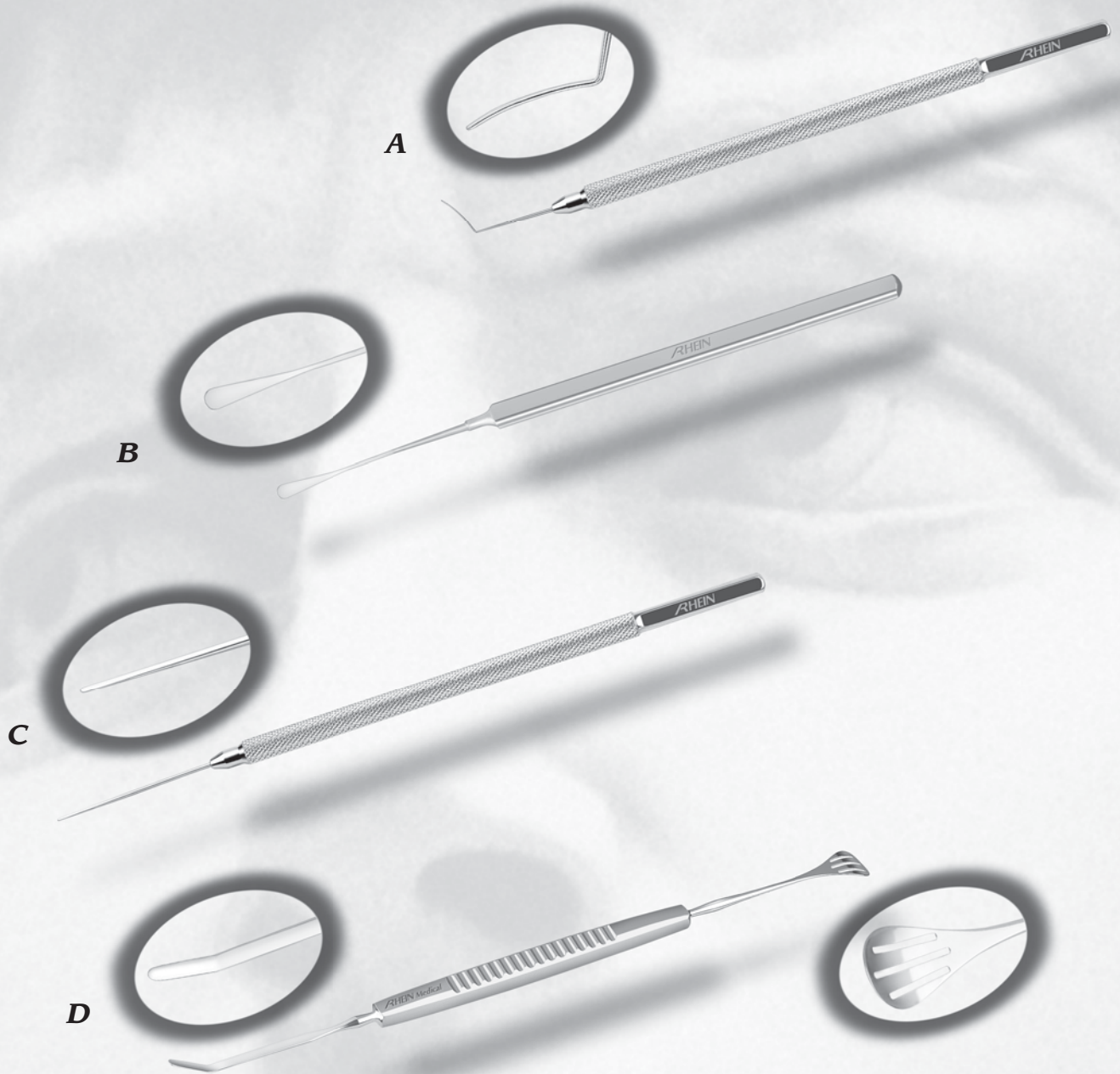

9.03

- A)** 8-07110 Johnson Spatula, 10mm Long
- B)** 8-07153 Kimura Malleable Flat Spatula, 4mm Wide
- C)** 8-07101 Knolle Lens Nucleus Spatula
- D)** 8-07137 Paton Double Ended Corneal Spatula And Spoon



ELEVATING THE QUALITY



1-800-263-3557



DIAMOND KNIVES

- **Titanium Cataract-10.01**
- **Miscellaneous-10.03**
- **Titanium Refractive & LRI-10.05**
- **Plastic Surgery-10.06**
- **Cleaning System-10.07**

Diamond Knives:

Our diamond blade gems offer unsurpassed results, and are 140 times harder than a sapphire or ruby. Properly maintained, our diamond blades offer unlimited surgical use with no degradation of incision quality. Our diamond knife handles are made entirely of titanium components, including the springs. Our diamonds are the finest in the world, and are honed by the most experienced diamond cutters on the planet. Most of our diamond knives have locks on the handles to prevent the diamond from being exposed during handling. Diamonds are extremely brittle, and should always be passed in the retracted and locked position. Please contact us for a videotape and instructions on recommended diamond knife handling and cleaning. The Rhein 3-D Blade® is protected by patent number 5,713,915, and is a registered trademark.



10.00



ELEVATING THE QUALITY OF CARE IN OPHTHALMOLOGY
800-637-4346



DIAMOND KNIVES

Titanium Cataract

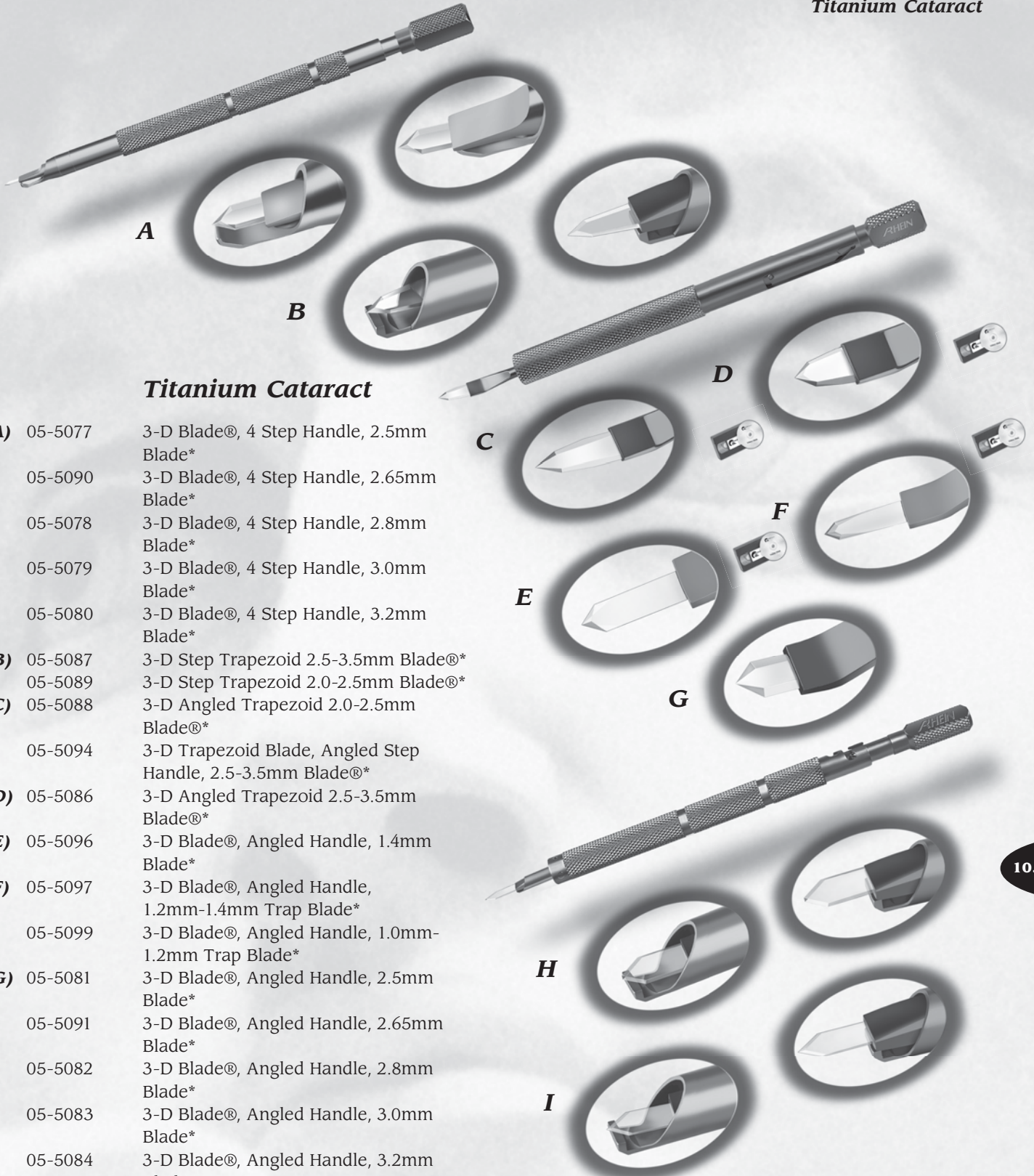

Titanium Cataract

- A)** 05-5077 3-D Blade®, 4 Step Handle, 2.5mm Blade*
- 05-5090 3-D Blade®, 4 Step Handle, 2.65mm Blade*
- 05-5078 3-D Blade®, 4 Step Handle, 2.8mm Blade*
- 05-5079 3-D Blade®, 4 Step Handle, 3.0mm Blade*
- 05-5080 3-D Blade®, 4 Step Handle, 3.2mm Blade*
- B)** 05-5087 3-D Step Trapezoid 2.5-3.5mm Blade®*
- 05-5089 3-D Step Trapezoid 2.0-2.5mm Blade®*
- C)** 05-5088 3-D Angled Trapezoid 2.0-2.5mm Blade®*
- 05-5094 3-D Trapezoid Blade, Angled Step Handle, 2.5-3.5mm Blade®*
- D)** 05-5086 3-D Angled Trapezoid 2.5-3.5mm Blade®*
- E)** 05-5096 3-D Blade®, Angled Handle, 1.4mm Blade*
- F)** 05-5097 3-D Blade®, Angled Handle, 1.2mm-1.4mm Trap Blade*
- 05-5099 3-D Blade®, Angled Handle, 1.0mm-1.2mm Trap Blade*
- G)** 05-5081 3-D Blade®, Angled Handle, 2.5mm Blade*
- 05-5091 3-D Blade®, Angled Handle, 2.65mm Blade*
- 05-5082 3-D Blade®, Angled Handle, 2.8mm Blade*
- 05-5083 3-D Blade®, Angled Handle, 3.0mm Blade*
- 05-5084 3-D Blade®, Angled Handle, 3.2mm Blade*
- H)** 05-5085 Rhein Advantage I Diamond Limbal Relaxing Incision Knife, 1mm Wide
- I)** 05-5095 Rhein Advantage II Diamond Limbal Relaxing Incision Knife, 0.75mm Wide

10.01

*U.S. Patent No. Re. 37,304



DIAMOND KNIVES

Titanium Cataract

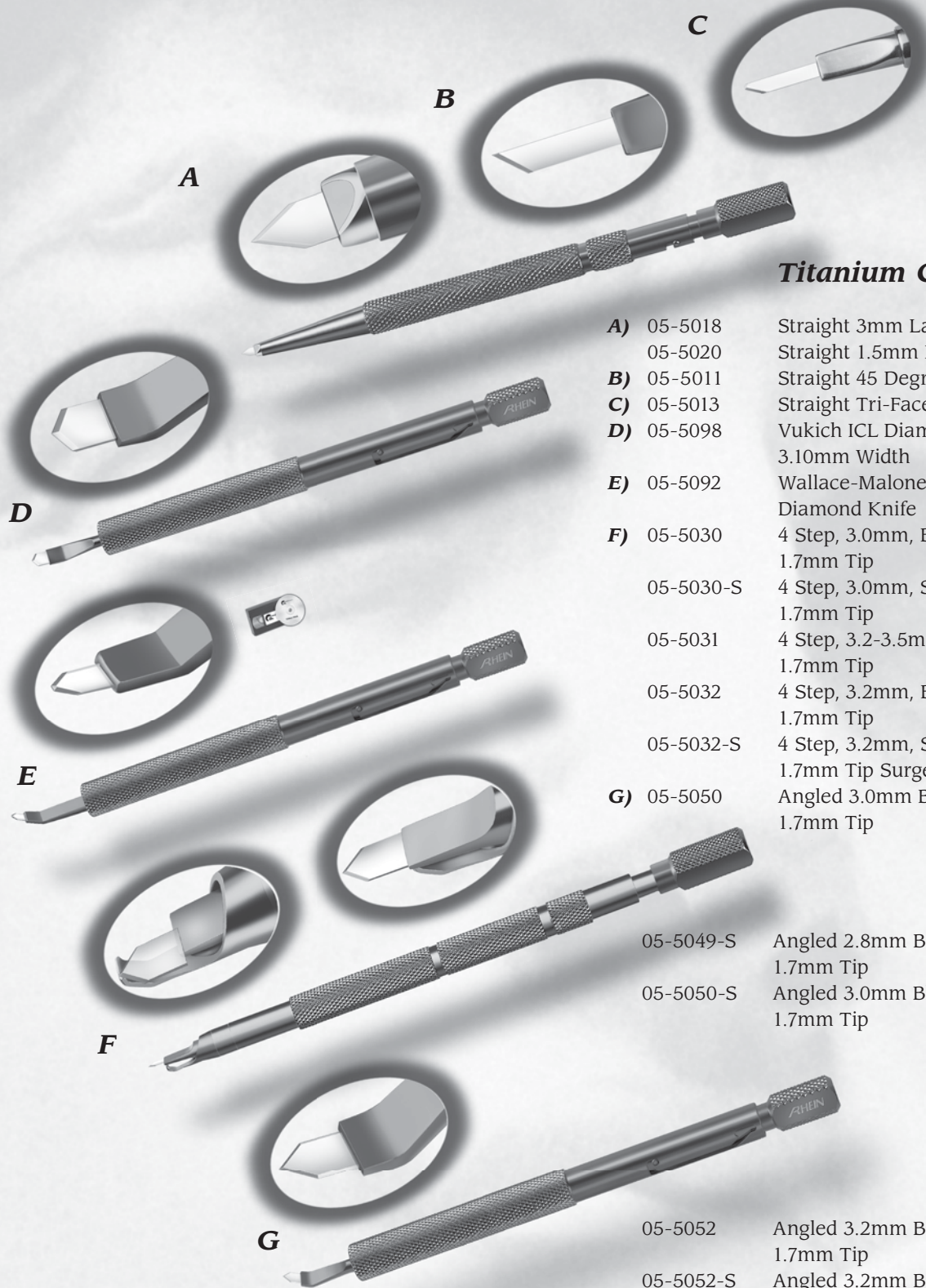

Titanium Cataract

- A)** 05-5018 Straight 3mm Lance Blade
05-5020 Straight 1.5mm Lance Blade
- B)** 05-5011 Straight 45 Degree, Single Edge Blade
- C)** 05-5013 Straight Tri-Facet Blade
- D)** 05-5098 Vukich ICL Diamond Blade, 3.10mm Width
- E)** 05-5092 Wallace-Maloney Fixation Diamond Knife
- F)** 05-5030 4 Step, 3.0mm, Blunt Side Edges, 1.7mm Tip
05-5030-S 4 Step, 3.0mm, Sharp Side Edges, 1.7mm Tip
05-5031 4 Step, 3.2-3.5mm Sharp Side Edges, 1.7mm Tip
05-5032 4 Step, 3.2mm, Blunt Side Edges, 1.7mm Tip
05-5032-S 4 Step, 3.2mm, Sharp Side Edges, 1.7mm Tip Surgery, Scalpel #15
- G)** 05-5050 Angled 3.0mm Blade, w/Blunt Sides, 1.7mm Tip

05-5049-S Angled 2.8mm Blade, w/Sharp Sides, 1.7mm Tip
05-5050-S Angled 3.0mm Blade, w/Sharp Sides, 1.7mm Tip

05-5052 Angled 3.2mm Blade, w/Blunt Sides, 1.7mm Tip
05-5052-S Angled 3.2mm Blade, w/Sharp Sides, 1.7mm Tip
05-5060 Angled 3.0mm 12 Facet Tapered

10.02



ELEVATING THE QUALITY OF CARE IN OPHTHALMOLOGY
800-637-4346



1-800-263-3557

DIAMOND KNIVES

Miscellaneous / CVD

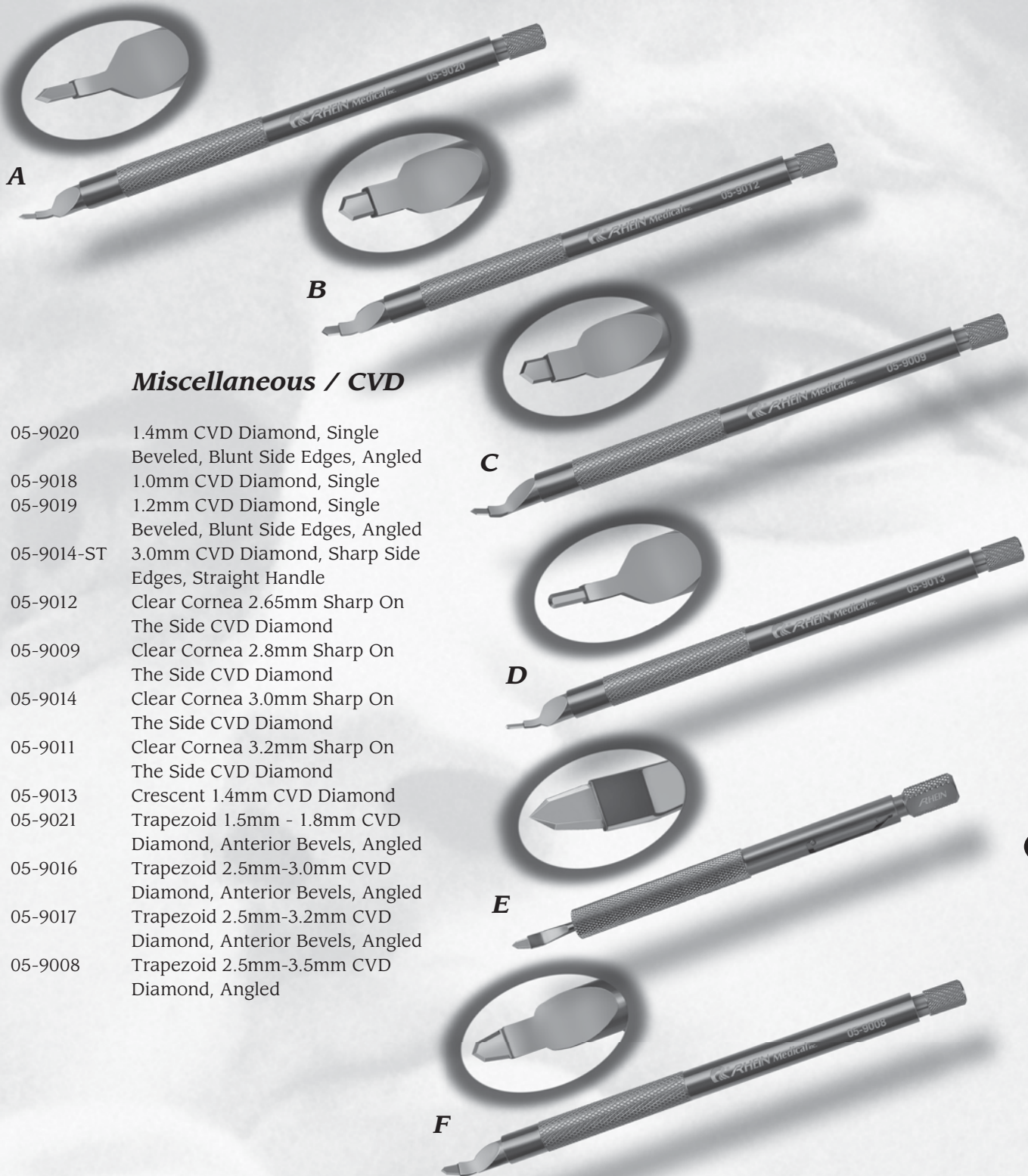

Miscellaneous / CVD

- A)** 05-9020 1.4mm CVD Diamond, Single Beveled, Blunt Side Edges, Angled
- 05-9018 1.0mm CVD Diamond, Single
- 05-9019 1.2mm CVD Diamond, Single Beveled, Blunt Side Edges, Angled
- 05-9014-ST 3.0mm CVD Diamond, Sharp Side Edges, Straight Handle
- B)** 05-9012 Clear Cornea 2.65mm Sharp On The Side CVD Diamond
- C)** 05-9009 Clear Cornea 2.8mm Sharp On The Side CVD Diamond
- 05-9014 Clear Cornea 3.0mm Sharp On The Side CVD Diamond
- 05-9011 Clear Cornea 3.2mm Sharp On The Side CVD Diamond
- D)** 05-9013 Crescent 1.4mm CVD Diamond
- E)** 05-9021 Trapezoid 1.5mm - 1.8mm CVD Diamond, Anterior Bevels, Angled
- 05-9016 Trapezoid 2.5mm-3.0mm CVD Diamond, Anterior Bevels, Angled
- F)** 05-9017 Trapezoid 2.5mm-3.2mm CVD Diamond, Anterior Bevels, Angled
- 05-9008 Trapezoid 2.5mm-3.5mm CVD Diamond, Angled

10.03



ELEVATING THE QUALITY



1-800-263-3557



DIAMOND KNIVES

Miscellaneous / Sapphire

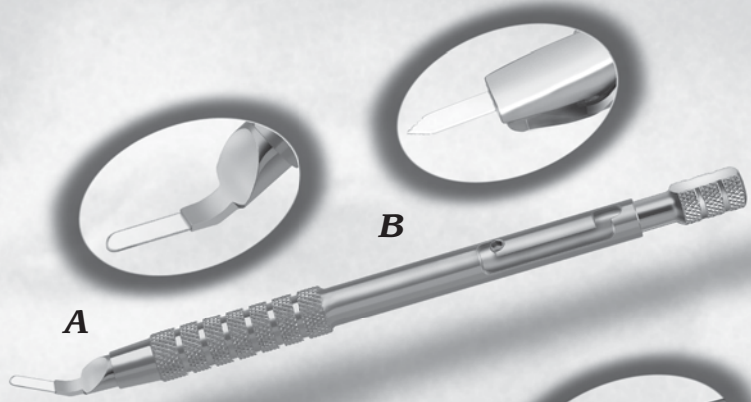

Miscellaneous / Sapphire

- A)** 05-9001 2.0mm Sapphire Crescent Knife
- B)** 05-9002 1.0mm Sapphire Dissection .3mm Step Knife w/Full Setting
- C)** 05-9006 Advantage I Sapphire Knife 1mm Snub Nose, .3&.6mm Presets
- D)** 05-9007 Advantage II Sapphire 0.75mm Sharp w/Blunt Edges, .3, .55, & .6mm Presets
- E)** 05-9004 Freehand 45 Degree Sapphire 1mm Knife, Straight
- F)** 05-9005 Freehand Spear Sapphire 1mm Knife, Straight
- G)** 05-9003 Freehand Tri-Facet Sapphire 1mm Knife, Straight
- H)** 05-9015 Nichamin Sapphire Fixation Knife

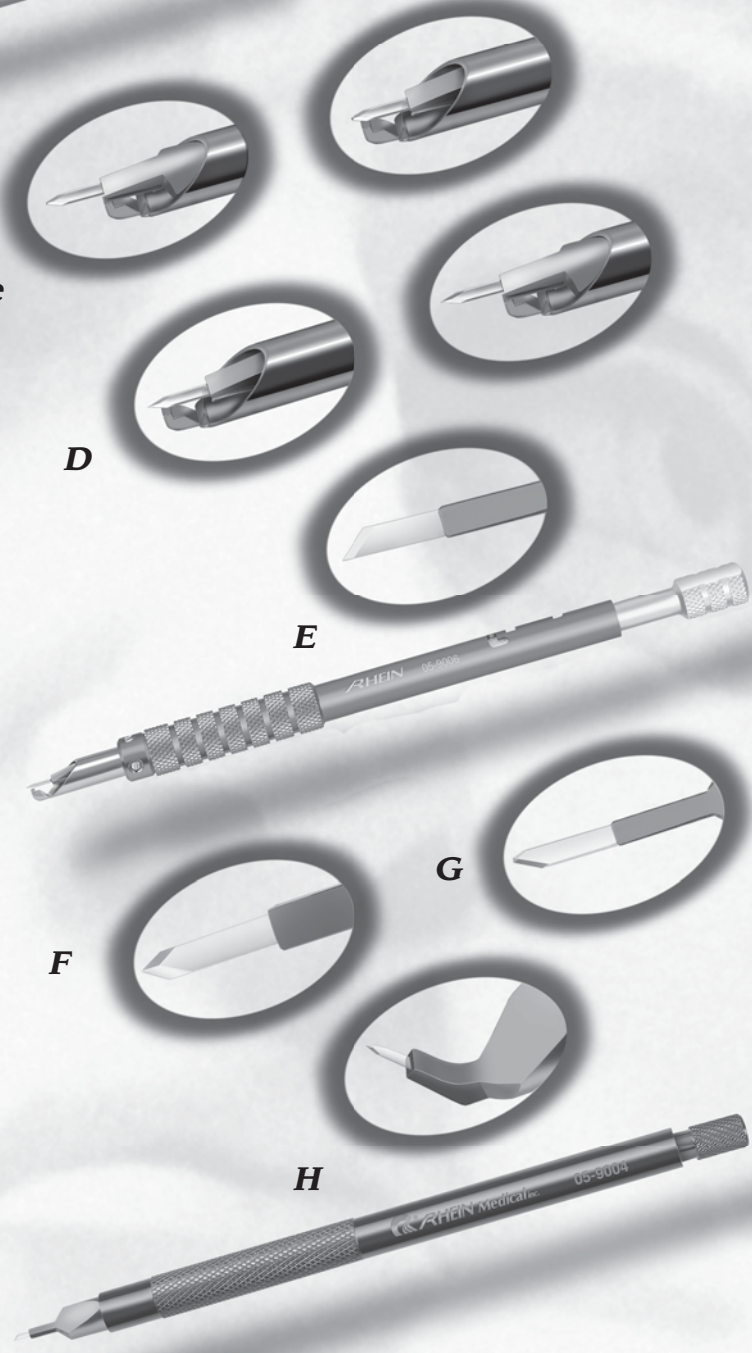

10.04



ELEVATING THE QUALITY OF CARE IN OPHTHALMOLOGY
800-637-4346



1-800-263-3557

DIAMOND KNIVES

Titanium Refractive & LRI

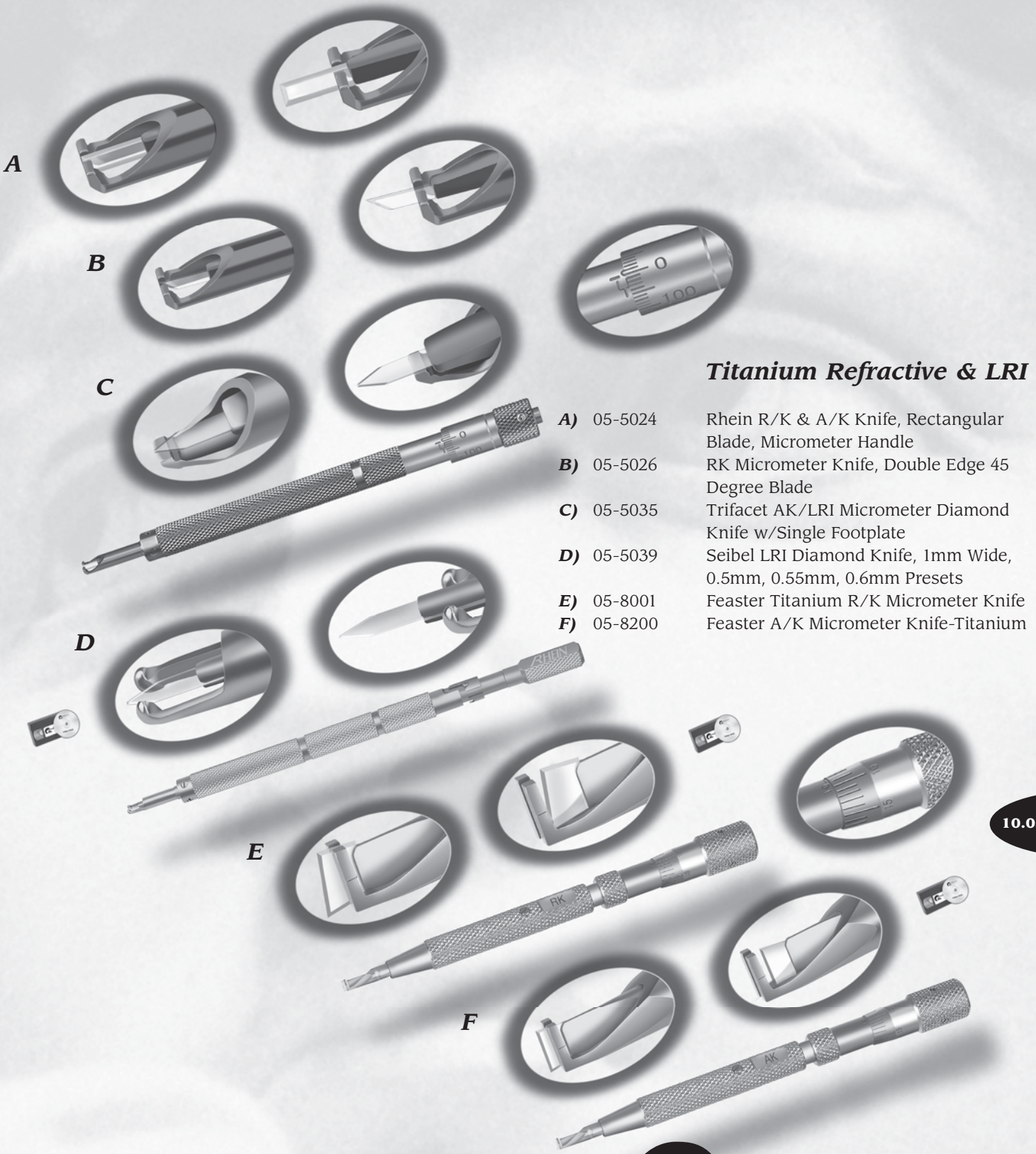

Titanium Refractive & LRI

- A)** 05-5024 Rhein R/K & A/K Knife, Rectangular Blade, Micrometer Handle
- B)** 05-5026 RK Micrometer Knife, Double Edge 45 Degree Blade
- C)** 05-5035 Trifacet AK/LRI Micrometer Diamond Knife w/Single Footplate
- D)** 05-5039 Seibel LRI Diamond Knife, 1mm Wide, 0.5mm, 0.55mm, 0.6mm Presets
- E)** 05-8001 Feaster Titanium R/K Micrometer Knife
- F)** 05-8200 Feaster A/K Micrometer Knife-Titanium

10.05



ELEVATING THE QUALITY



1-800-263-3557



DIAMOND KNIVES

Plastic Surgery

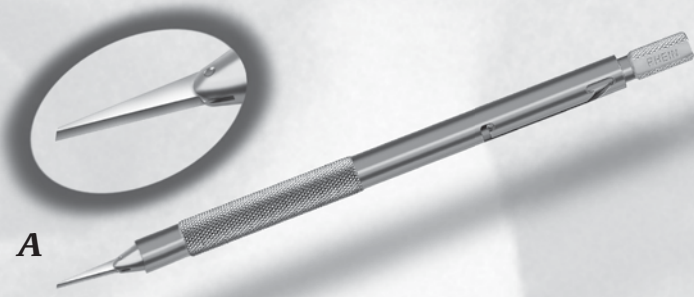

A

Plastic Surgery

- A) 05-8111 CVD Diamond Knife For Soft Tissue Surgery, Scalpel #11
- B) 05-8115 CVD Diamond Knife For Soft Tissue Surgery, Scalpel #15



B

10.06



ELEVATING THE QUALITY OF CARE IN OPHTHALMOLOGY
800-637-4346



1-800-263-3557



A

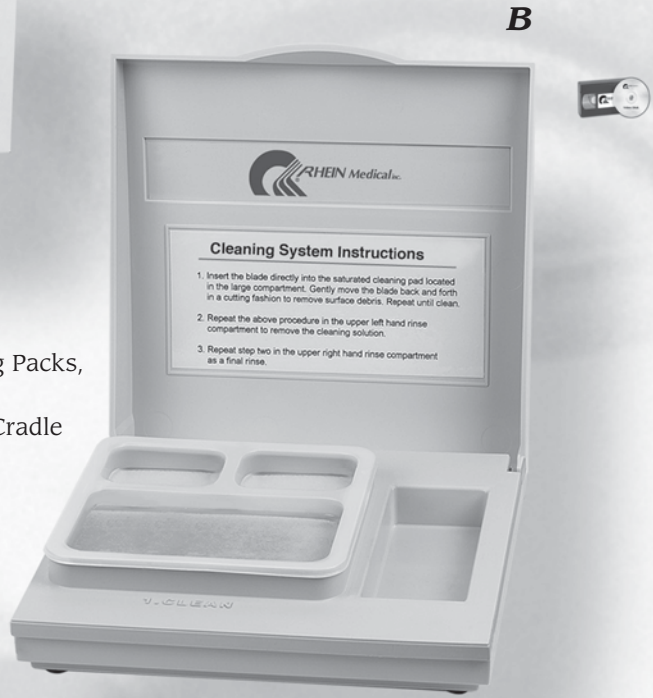

B

Cleaning System

- A)** 09-7018 Rhein Disposable Knife Cleaning Packs, 12/Box
- B)** 09-7017 Rhein Reusable Knife Cleaning Cradle w/One Pack

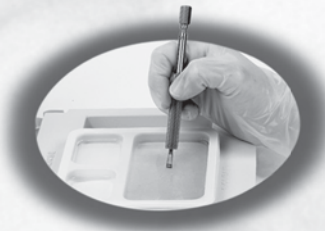

Step 1

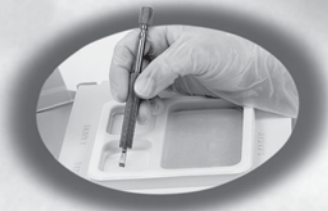

Step 2

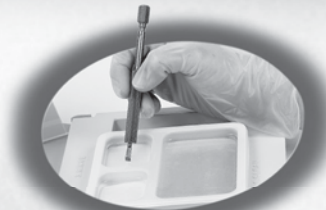

Step 3

10.07



REUSABLE KNIVES



11.00



ELEVATING THE QUALITY OF CARE IN OPHTHALMOLOGY
800-637-4346



1-800-263-3557

REUSABLE KNIVES



- A)** 8-10123 Gill Knife, Slightly Curved 3.5mm Blade
- B)** 8-10141 Girard Swan Knife, 1.5mm Blade
- C)** 8-10142 Suarez Spreader
- D)** 8-10126 Tooke Knife 4-1/2", 2.5 x 15mm
- E)** 8-10101 Von Graefe Cataract Knife #1, 1.5 x 25mm
- 8-10102 Von Graefe Cataract Knife #2, 1.7 x 27mm
- 8-10103 Von Graefe Cataract Knife #3, 2 x 30mm
- 8-10104 Von Graefe Cataract Knife #4, 2.3 x 33mm
- 8-10105 Von Graefe Cataract Knife #5, 2.5 x 35mm
- F)** 8-10106 Wheller Dissection Knife
- G)** 8-10112 Ziegler Knife-Needle 4-1/2", Size 0, 3mm Blade
- 8-10113 Ziegler Knife-Needle 4-1/2", Size 1, 5mm Blade
- 8-10114 Ziegler Knife-Needle 4-1/2", Size 2, 6mm Blade
- 8-10115 Ziegler Knife-Needle 4-1/2", Size 3, 7mm Blade

11.01



ELEVATING THE QUALITY



1-800-263-3557

DILATORS



12.00



ELEVATING THE QUALITY OF CARE IN OPHTHALMOLOGY
800-637-4346



1-800-263-3557

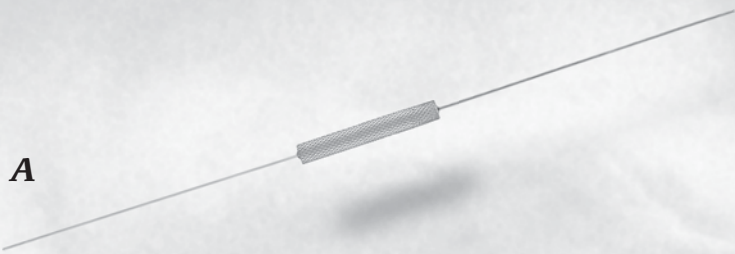

A

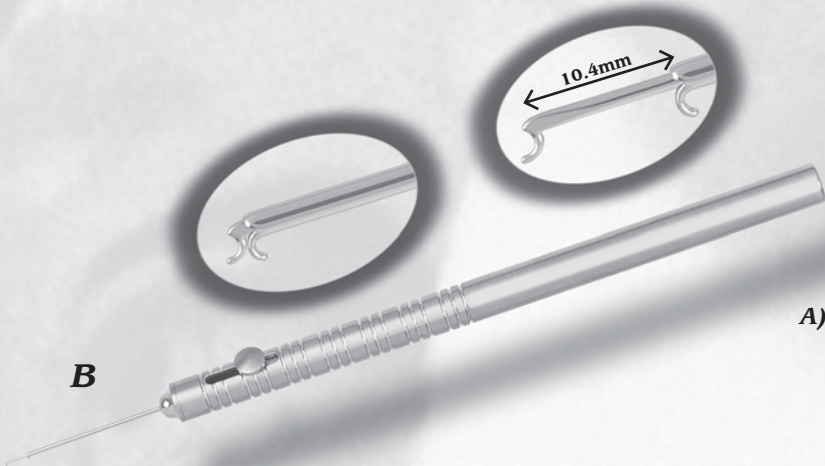

B

- | | | |
|-----------|-----------|---|
| A) | 8-09122 | Bowman Lacrimal Probe Size 0000-000 |
| | 8-09123 | Bowman Lacrimal Probe Size 00-0 |
| | 8-09124 | Bowman Lacrimal Probe Size 1-2 |
| | 8-09125 | Bowman Lacrimal Probe Size 3-4 |
| | 8-09126 | Bowman Lacrimal Probe Size 5-6 |
| | 8-09127 | Bowman Lacrimal Probe Size 7-8 |
| B) | 8-09133-A | Brown Pupil Dilator, Phaco Incision |
| C) | 8-09133-B | Brown Side Port Pupil Dilator |
| D) | 8-09110 | Castroviejo Lacrimal Dilator Double-Ended |

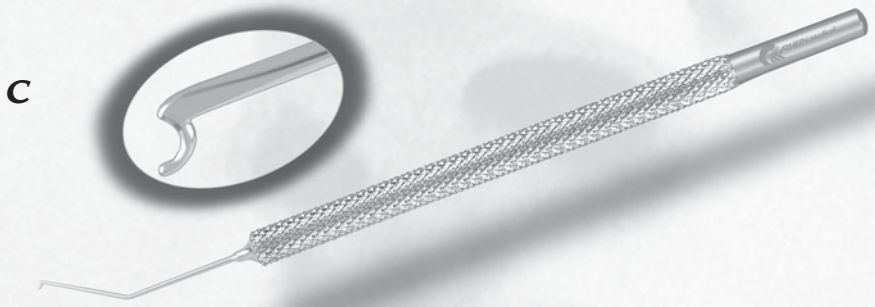

C



D

12.01



ELEVATING THE QUALITY

1-800-263-3557



DILATORS

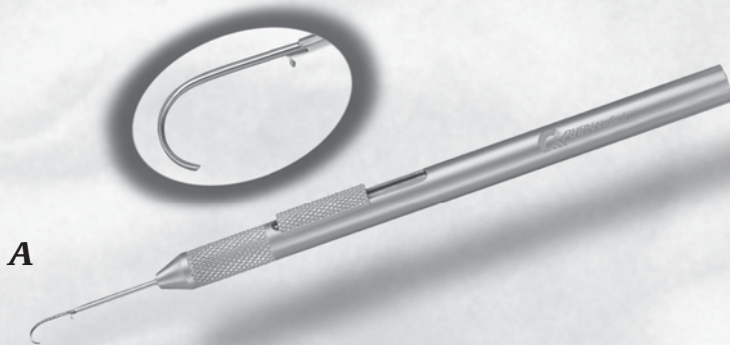

A

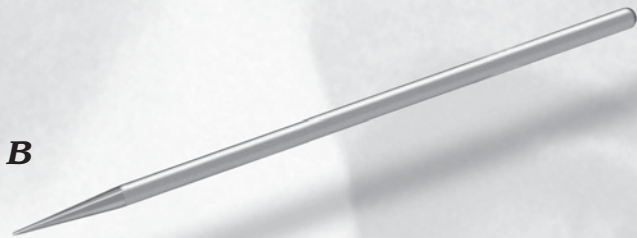

B

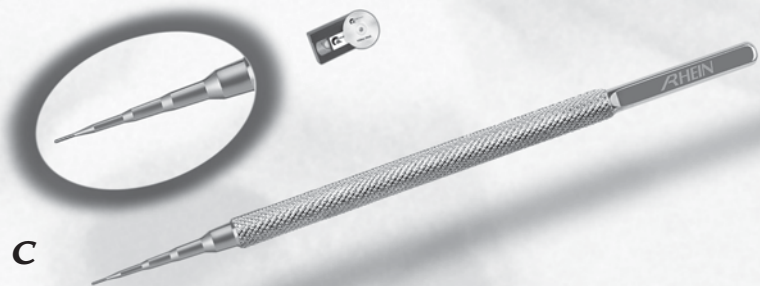

C

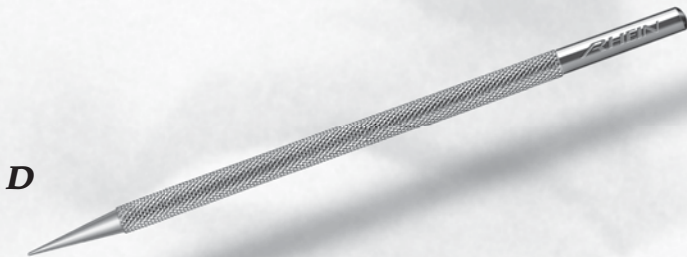

D

- A)** 8-09132 Peters Pupil Dilator
8-09132-L Peters Pupil Dilator Loop
- B)** 8-09109 Ruedemann Infant Lacrimal Dilator 3", .5mm
- C)** 8-09130 Sisler Punctum Dilator
- D)** 8-09106 Wilder Lacrimal Dilator, Fine Taper
8-09108 Wilder Lacrimal Dilator, Heavy Taper
8-09107 Wilder Lacrimal Dilator, Medium Taper

12.02



ELEVATING THE QUALITY OF CARE IN OPHTHALMOLOGY
800-637-4346



1-800-263-3557

12.03



ELEVATING THE QUALITY



ACOR

1-800-263-3557



FORCEPS

- **Bi-Polar-13.01**
- **Capsule-Stainless-13.01**
- **Capsule-Titanium-13.05**
- **Chalazion-13.08**
- **Cilia-13.10**
- **Corneal-Stainless-13.11**
- **Corneal-Titanium-13.18**
- **Dressing-13.20**
- **Foldable Lens Loaders & Inserters-13.21**
- **Jeweler-13.25**
- **Lens-13.27**
- **Miscellaneous-13.34**
- **Mosquito-13.36**
- **Nucleus Splitting-13.37**
- **Serrefine-13.37**
- **Tying-Stainless-13.38**
- **Tying -Titanium-13.41**

Capsulorrhexis Forceps:

Our capsulorrhexis forceps are available in a variety of configurations. Some have formed blades, gaps between the blades, cystotome tips, and rounded distal tips. Contact our customer service staff for more information about our selection.

PMMA & Foldable Lens Forceps:

The jaws of our lens insertion forceps are mirror-polished in the blades to prevent any damage to intraocular lenses. Our foldable lens loading forceps are designed to pick up and fold lenses from a flat surface, in the air, or under a microscope.

Tying & Corneal Forceps:

Our titanium flat-handled forceps have an elongated opening along the handles for lighter weight and more comfortable handling. Our round-handled forceps have a flat ridge along the spine of the handle. This ridge offers the combined advantages of a flat handle for stability and tactile feedback, along with the benefits of a round handle for uninterrupted rotation. All of our tying platforms in our titanium forceps are impregnated with tungsten carbide to improve grip over sutures.



13.00



ELEVATING THE QUALITY OF CARE IN OPHTHALMOLOGY
800-637-4346



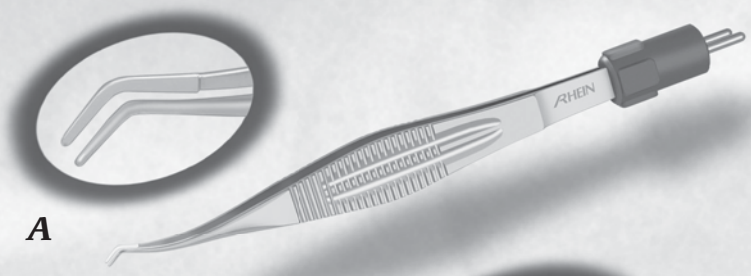

A

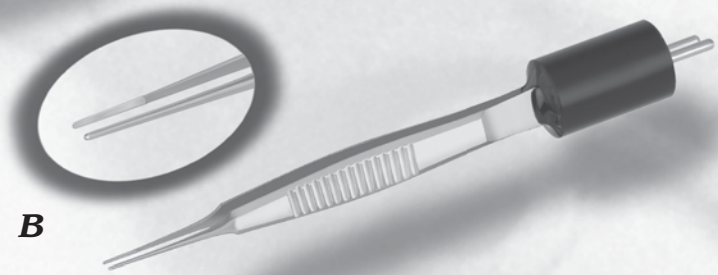

B

Bi-Polar Forceps

- A)** 8-13221 Coaptation Bi-Polar Forceps
- 8-13222 Jewelers Bi-Polar Forceps
- B)** 8-13219 McPherson Straight Bi-Polar Forceps
- 8-13220 McPherson Angled Bi-Polar Forceps
- 8-13146 12' Bi-Polar Cable (Reusable)
- 8-13147 12' Heavy Duty Bi-Polar Cable (Reusable)



C

Capsule Forceps-Stainless

- C)** 8-01402 Arruga Capsule Forceps, Standard
- 8-01401 Arruga, New Curve, Wide Handle
- D)** 8-01419 Fine 20g Irrigating Capsulorrhesis Forceps, 1.4mm Incision
- 8-01420 Fine 22g Irrigating Capsulorrhesis Forceps, 1.1mm Incision

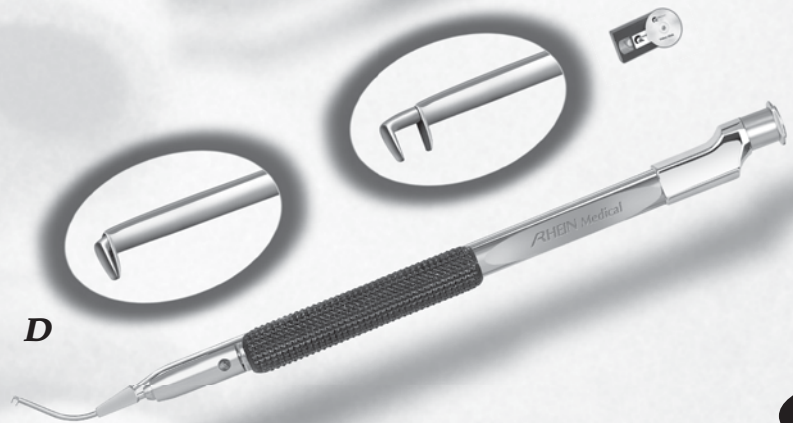

D

13.01



FORCEPS

Capsule Forceps-Stainless

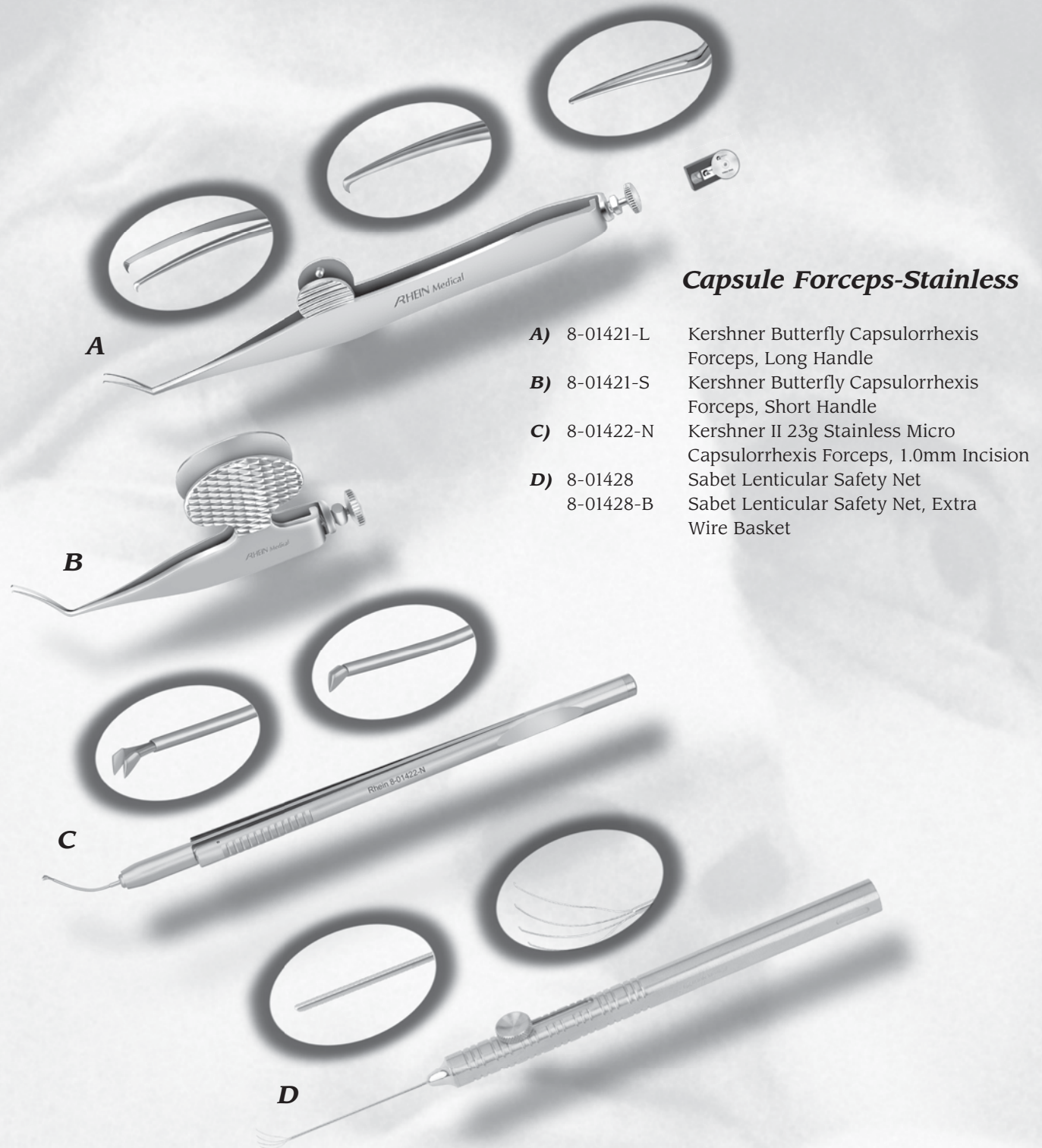

Capsule Forceps-Stainless

- A)** 8-01421-L Kershner Butterfly Capsulorrhexis Forceps, Long Handle
- B)** 8-01421-S Kershner Butterfly Capsulorrhexis Forceps, Short Handle
- C)** 8-01422-N Kershner II 23g Stainless Micro Capsulorrhexis Forceps, 1.0mm Incision
- D)** 8-01428 Sabet Lenticular Safety Net
8-01428-B Sabet Lenticular Safety Net, Extra Wire Basket

13.02



ELEVATING THE QUALITY OF CARE IN OPHTHALMOLOGY
800-637-4346



1-800-263-3557

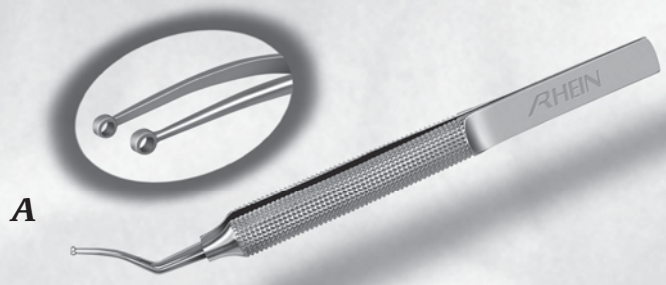

A

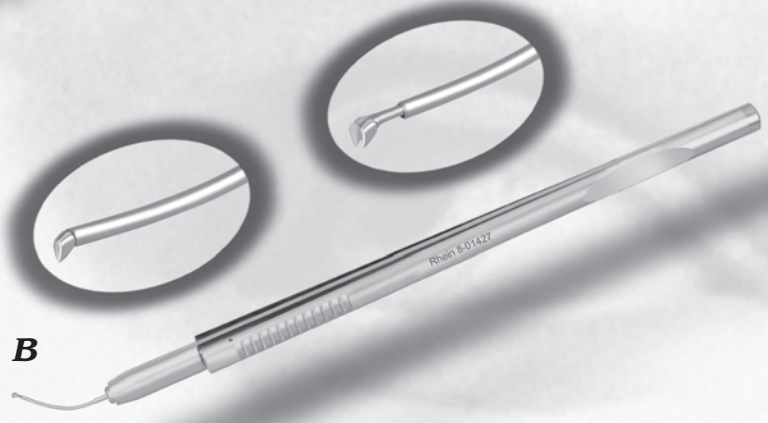

B

Capsule Forceps-Stainless

- A)** 8-01416 Khouri Nuclear Fragment Removal Forceps
- B)** 8-01427 Rhein Tubular 23g Capsulorrhexis Forceps, 1.0mm Incision, Stainless
- C)** 8-01424 Short Capsulorrhexis Forceps, Formed Cystotome Tips, Flat Handle
- D)** 8-01426 Short Capsulorrhexis Forceps, Formed Cystotome Tips, Round Handle

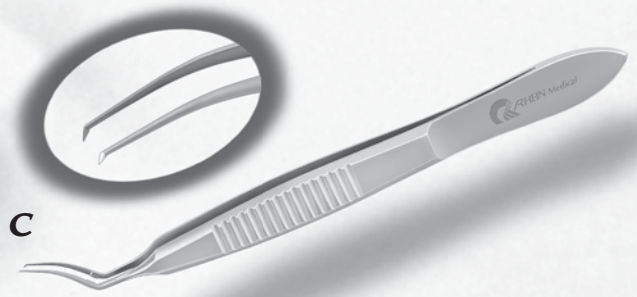

C

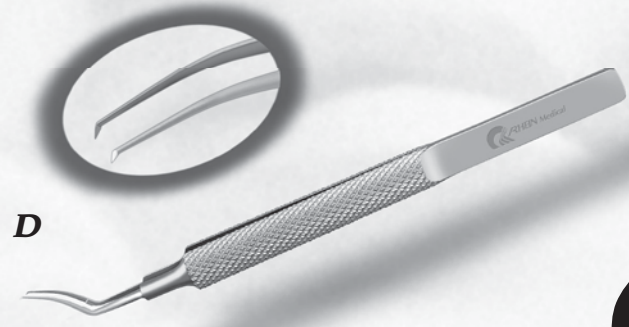

D

13.03



FORCEPS

Capsule Forceps-Stainless

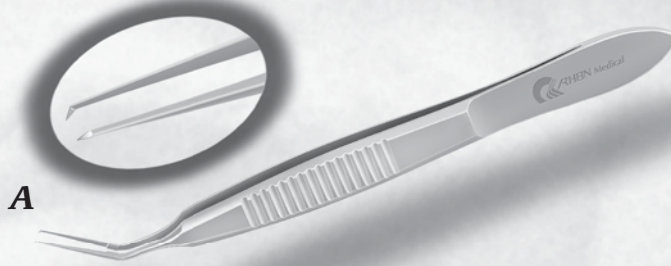

A

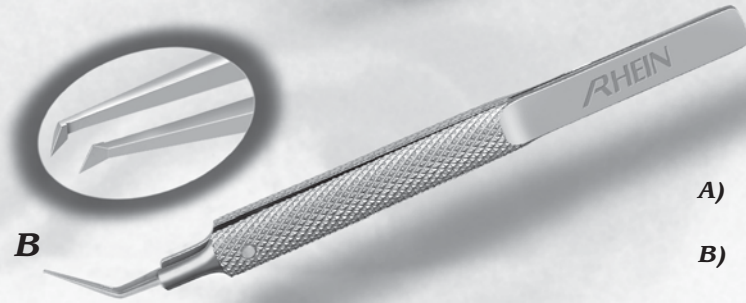

B



C

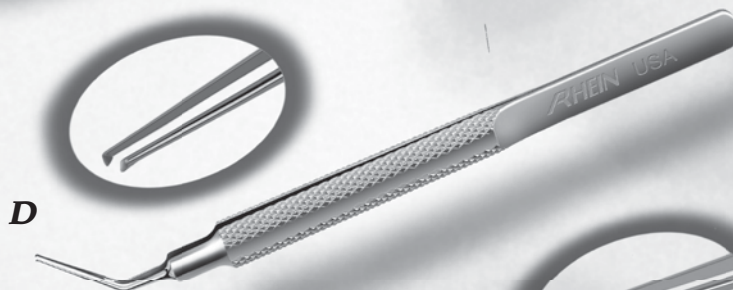

D

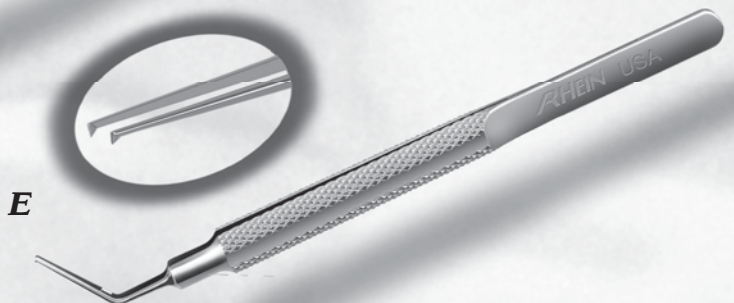

E

Capsule Forceps-Stainless

- A) 8-01423 Short Capsulorrhexis Forceps, Straight Cystotome Tips, Flat Handle
- B) 8-01425 Short Capsulorrhexis Forceps, Straight Cystotome Tips, Round Handle
- C) 8-01413 Ultrata Capsulorrhexis Forceps - Flat Handle
- D) 8-01414 Ultrata Capsulorrhexis Forceps - Round Handle
- E) 8-01415 Ultrata/Kershner Capsulorrhexis Cystotome Forceps 11.5mm Blades

13.04



ELEVATING THE QUALITY OF CARE IN OPHTHALMOLOGY
800-637-4346



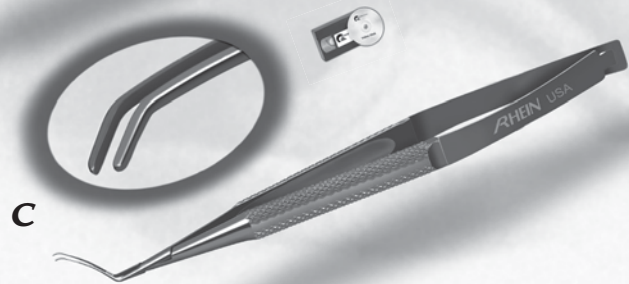
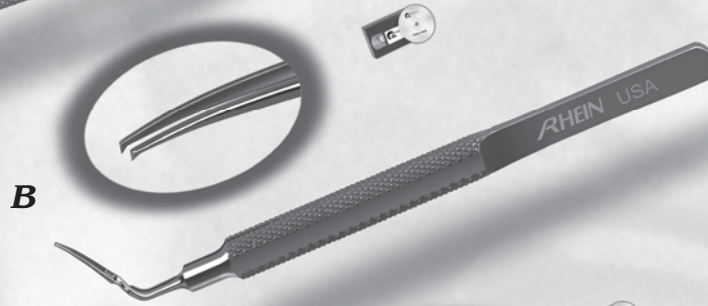

Capsule Forceps-Titanium

- A)** 05-2329 Brown-Grabow Capsulorrhexis Cystotome Forceps-Titanium
- B)** 05-2328 Casebeer Capsulorrhexis Forceps-Titanium
- C)** 05-2327 Connor Capsulorrhexis Peeler Forceps-Titanium
- D)** 05-2360 Fine Head-Tilt Capsulorrhexis Cystotome Forceps-Titanium
- E)** 05-2321 Rhein Colbri Capsulorrhexis Forceps 0.1mm Pierce Formed Jaws-Titanium

13.05



ELEVATING THE QUALITY



1-800-263-3557



FORCEPS

Capsule Forceps-Titanium

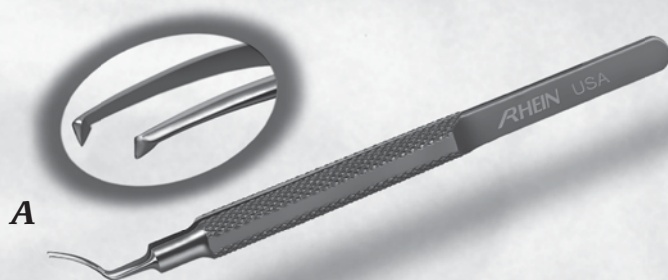

A

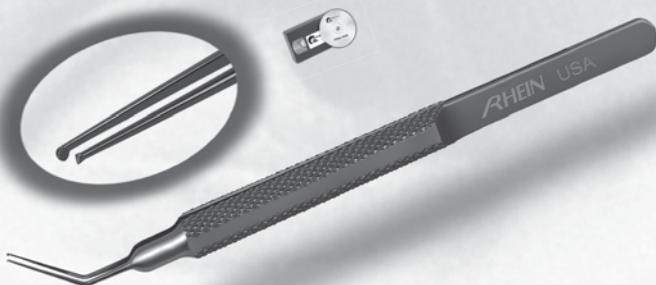

B



C

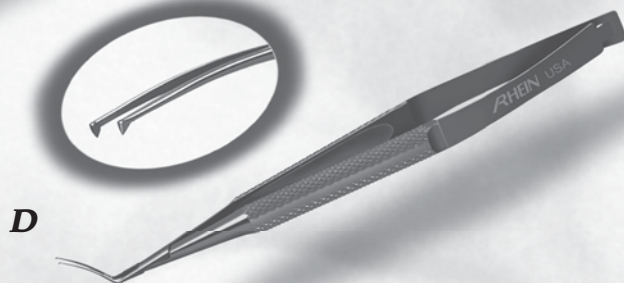

D

Capsule Forceps-Titanium

- A) 05-2323 Formed Ultrata/Kershner Capsulorrhexis Cystotome Forceps, 11.5mm Blades-Titanium
- B) 05-2361 Goldman Capsulorrhexis Forceps-Titanium
- C) 05-2320 Kershner Capsulorrhexis Forceps, 8mm Blades-Titanium
- D) 05-2326 Rhein Capsulorrhexis Cystotome Forceps-Titanium

13.06



ELEVATING THE QUALITY OF CARE IN OPHTHALMOLOGY
800-637-4346



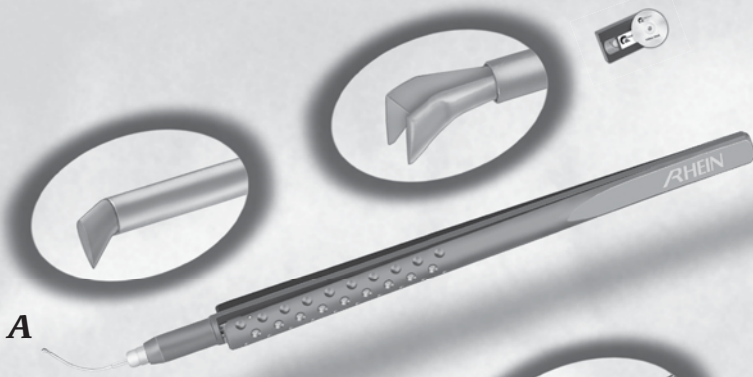

A

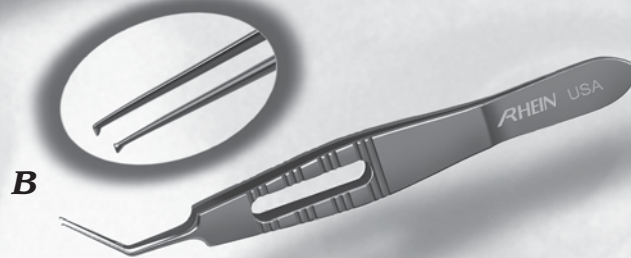

B

Capsule Forceps-Titanium

- A)** 05-2362 Rhein Tubular 23g Capsulorrhexis Forceps, 1.0mm Incision-Titanium
- B)** 05-2318 Ultrata Capsulorrhexis Forceps, Flat Handle-Titanium
- C)** 05-2319 Ultrata Capsulorrhexis Forceps, Round Handle-Titanium
- D)** 05-2322 Ultrata/Kershner Capsulorrhexis Cystotome Forceps 11.5mm Blades-Titanium

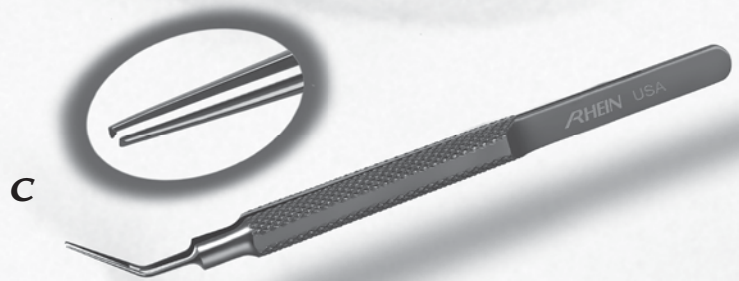

C



D

13.07



ELEVATING THE QUALITY



1-800-263-3557



FORCEPS

Chalazion Forceps

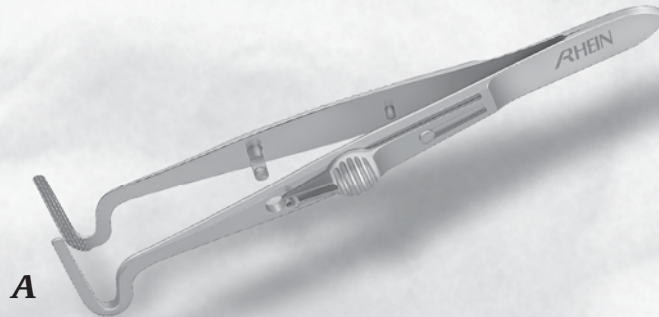

A

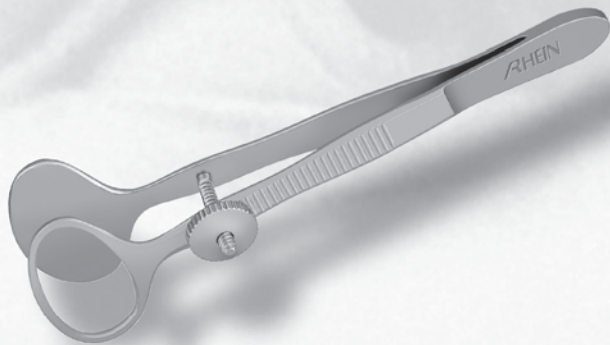

B

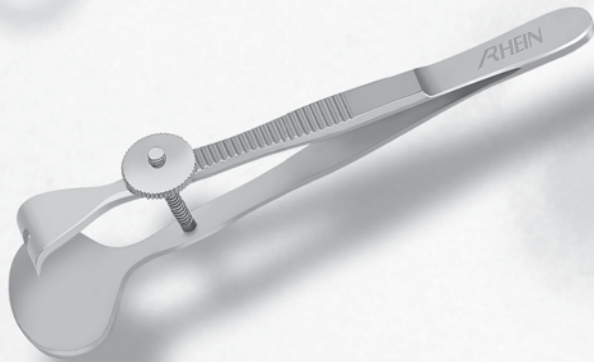

C

Chalazion Forceps

- A)** 8-01704 Berke Ptosis Forceps, 20mm Blades w/Lock
- 8-01705 Berke Ptosis Forceps, 27mm Blades w/Lock
- B)** 8-01703 Desmarres Forceps, Large 17x28mm
- 8-01702 Desmarres Forceps, Medium 12x23mm
- 8-01701 Desmarres Forceps, Small 11x17mm
- C)** 8-01706 Ehrhardt Lid Forceps, Serrated Jaw 9.5mm

13.08



ELEVATING THE QUALITY OF CARE IN OPHTHALMOLOGY
800-637-4346



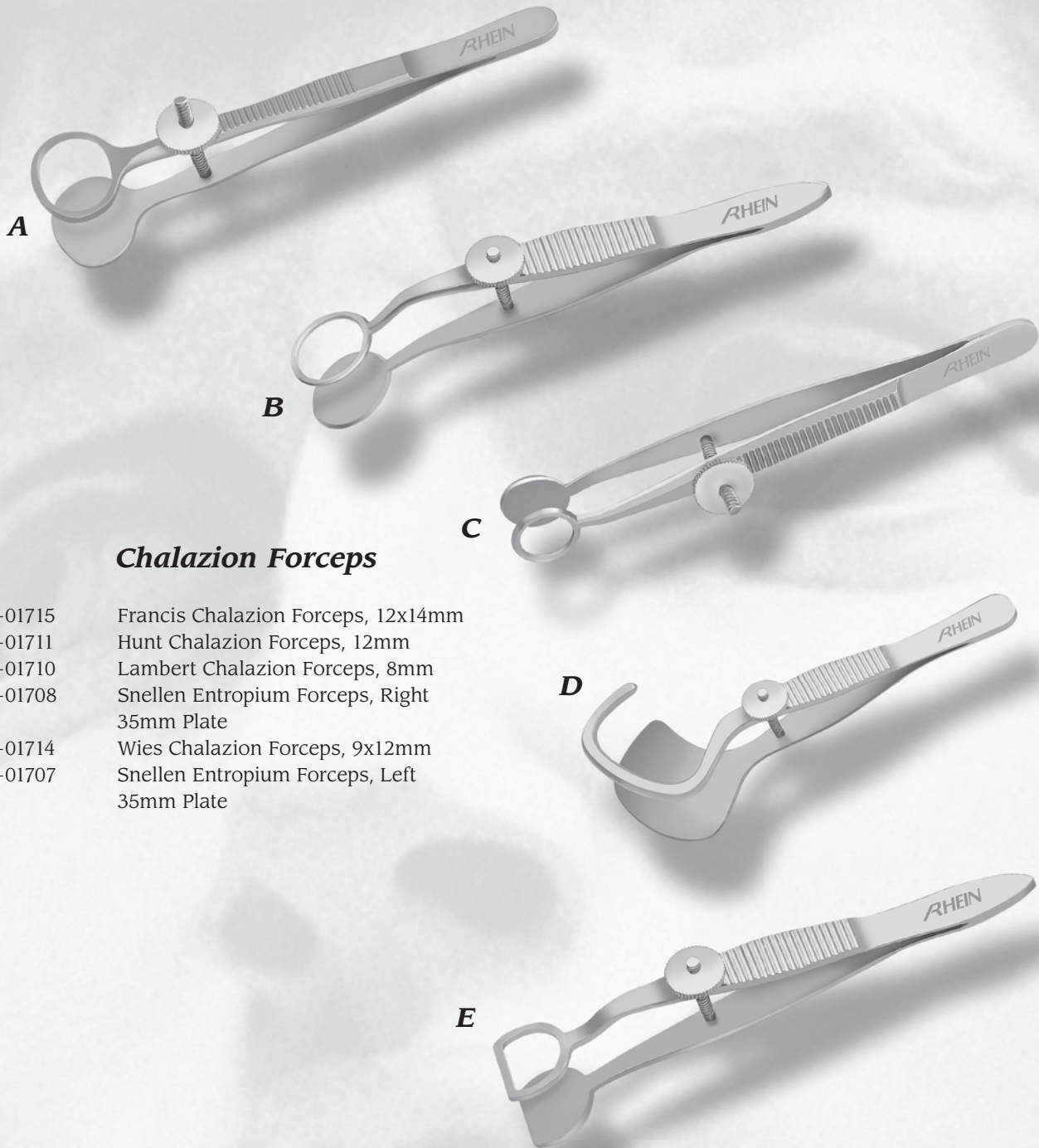

Chalazion Forceps

- A)** 8-01715 Francis Chalazion Forceps, 12x14mm
- B)** 8-01711 Hunt Chalazion Forceps, 12mm
- C)** 8-01710 Lambert Chalazion Forceps, 8mm
- D)** 8-01708 Snellen Entropium Forceps, Right 35mm Plate
- E)** 8-01714 Wies Chalazion Forceps, 9x12mm
- 8-01707 Snellen Entropium Forceps, Left 35mm Plate

13.09



ELEVATING THE QUALITY



1-800-263-3557



FORCEPS

Cilia Forceps

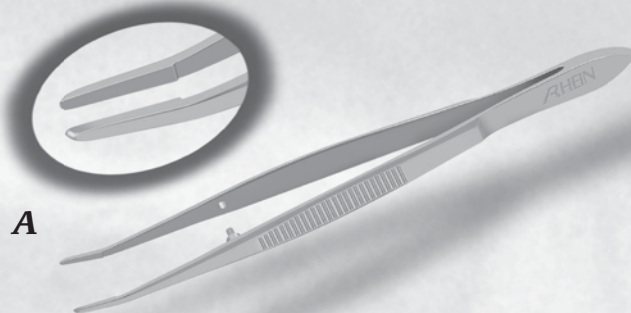

A

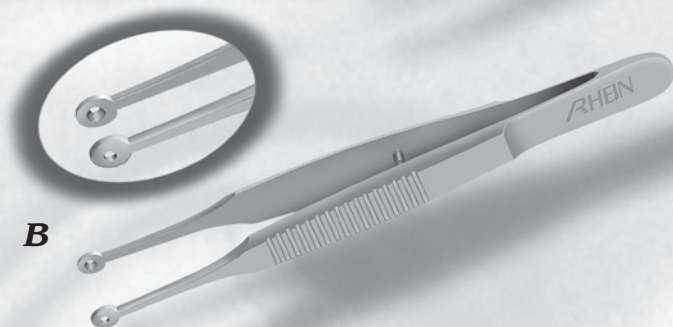

B

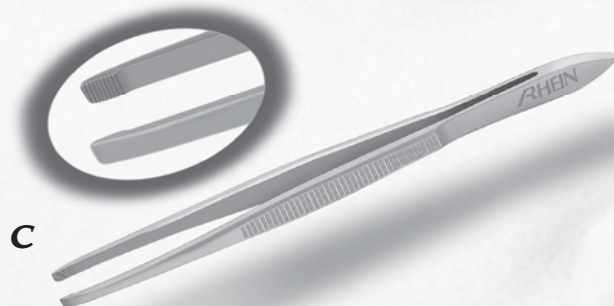

C



D

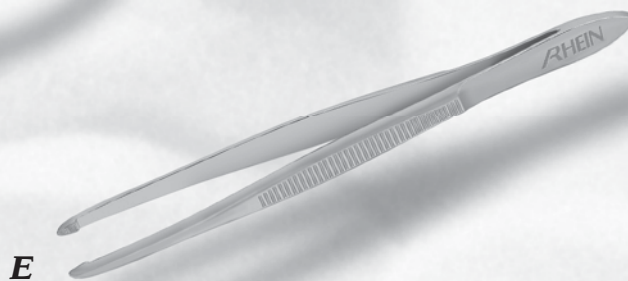

E

Cilia Forceps

- | | |
|-------------------|---------------------------------------|
| A) 8-01602 | Barraquer Cilia Forceps |
| B) 8-01624 | Bennett Cilia Forceps, 3mm Cup Jaws |
| C) 8-01619 | Douglas Cilia Forceps, 2.5mm |
| D) 8-01626 | Gradle Cilia Forceps, 1.4mm Wide Jaws |
| E) 8-01620 | Ziegler Cilia Forceps, 3-1/2", Smooth |

13.10



ELEVATING THE QUALITY OF CARE IN OPHTHALMOLOGY
800-637-4346



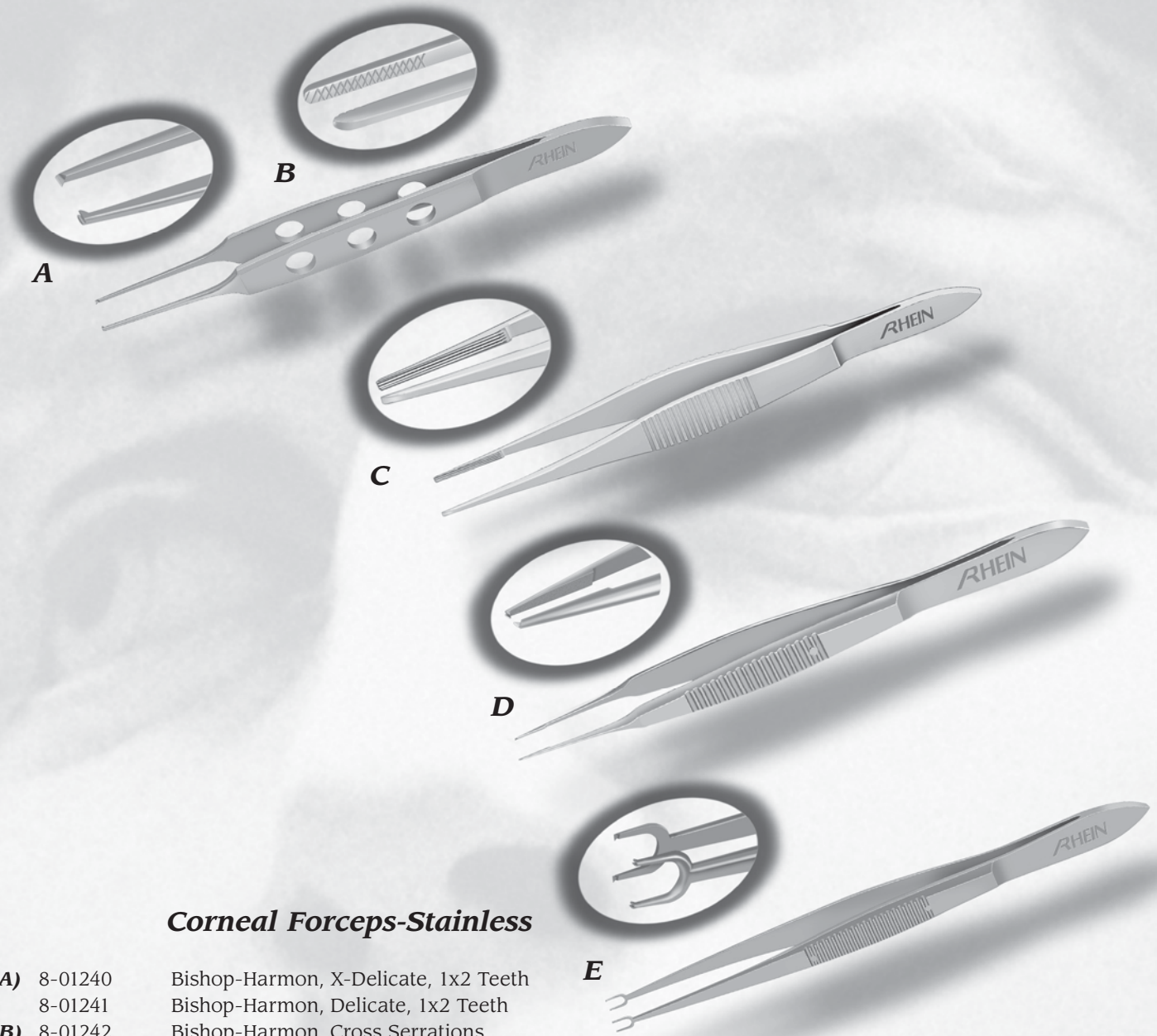

Corneal Forceps-Stainless

- A)** 8-01240 Bishop-Harmon, X-Delicate, 1x2 Teeth
8-01241 Bishop-Harmon, Delicate, 1x2 Teeth
- B)** 8-01242 Bishop-Harmon, Cross Serrations
- C)** 8-01265 Bonaccolto Utility, 1.2mm Jaws
8-01266 Bonaccolto Utility, 1.7mm Jaws
- D)** 8-01205 Bonn Long Forceps, .12mm 1x2 Teeth,
95mm Length, 5mm Tying Platform
8-01204 Bonn Short Forceps, .12mm 1x2 Teeth,
75mm Length
- E)** 8-01280 Bores Fixation Forceps, 1x2, .12mm
Straight

13.11



ELEVATING THE QUALITY



1-800-263-3557



FORCEPS

Corneal Forceps-Stainless

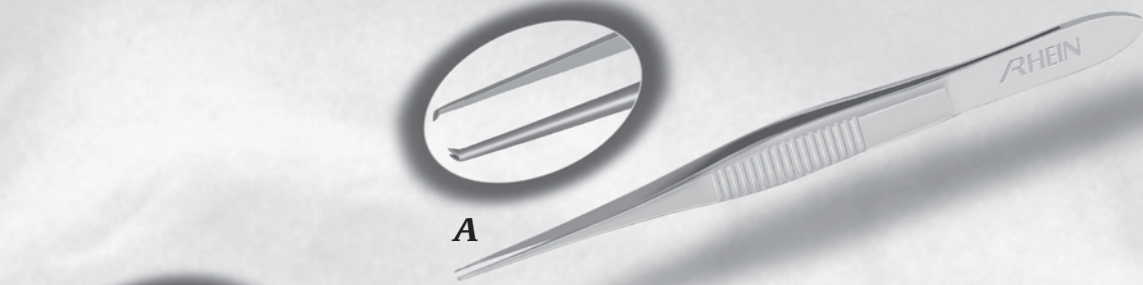

A

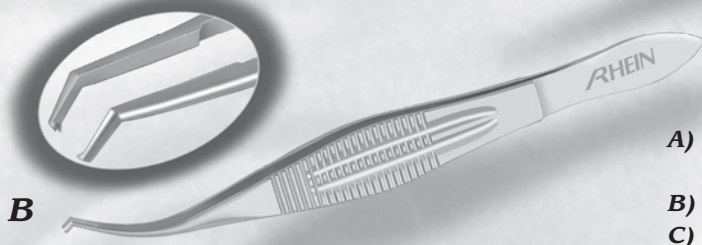

B

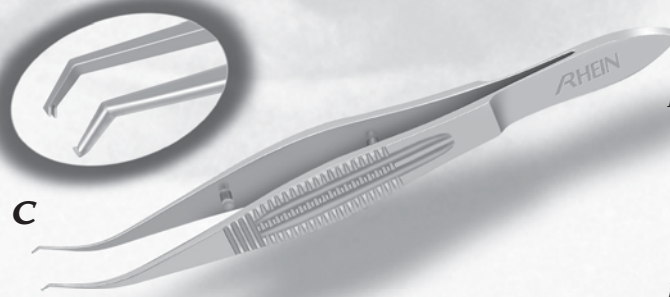

C

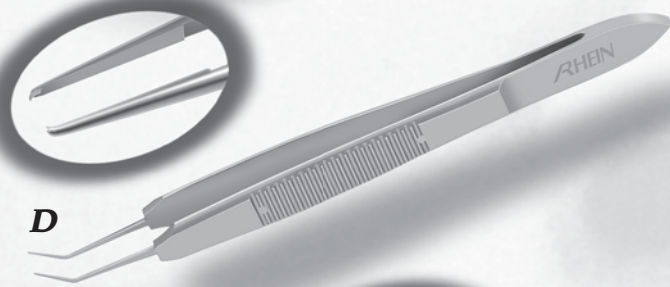

D

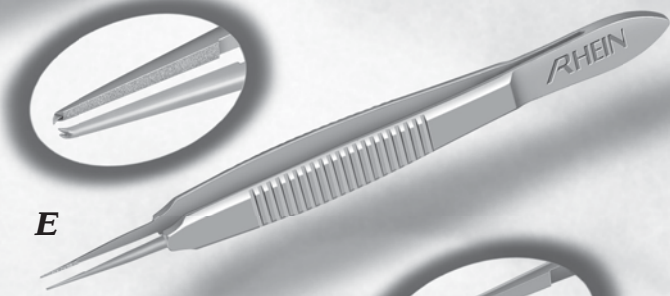

E



F

Corneal Forceps-Stainless

- A)** 8-01302 Hyde Corneal Forceps, 2x2 Teeth, 0.12mm w/Tying Platform
- B)** 8-01301 Bracken Fixation Forceps, 1x2 Teeth
- C)** 8-01259 Castroviejo Colibri, .12mm
- D)** 8-01251 Castroviejo, .12mm, Angled, 5mm Tying Platform
- 8-01252 Castroviejo, .3mm, Angled
- 8-01253 Castroviejo, .5mm, Angled
- E)** 8-01248 Castroviejo, .12mm, Straight, 5mm Tying Platform
- 8-01249 Castroviejo, .3mm, Straight, 5mm Tying Platform
- 8-01250 Castroviejo, .5mm, Straight, 5mm Tying Platform
- F)** 8-01254 Castroviejo, .12mm, Wide Handle, Straight, 5mm Tying Platform
- 8-01255 Castroviejo, .3mm, Wide Handle, Straight, 5mm Tying Platform
- 8-01256 Castroviejo, .5mm, Wide Handle, Straight, 5mm Tying Platform
- 8-01257 Castroviejo, .6mm, Wide Handle, Straight, 8mm Tying Platform
- 8-01258 Castroviejo, .9mm, Wide Handle, Straight, 5mm Tying Platform

13.12



ELEVATING THE QUALITY OF CARE IN OPHTHALMOLOGY
800-637-4346



1-800-263-3557

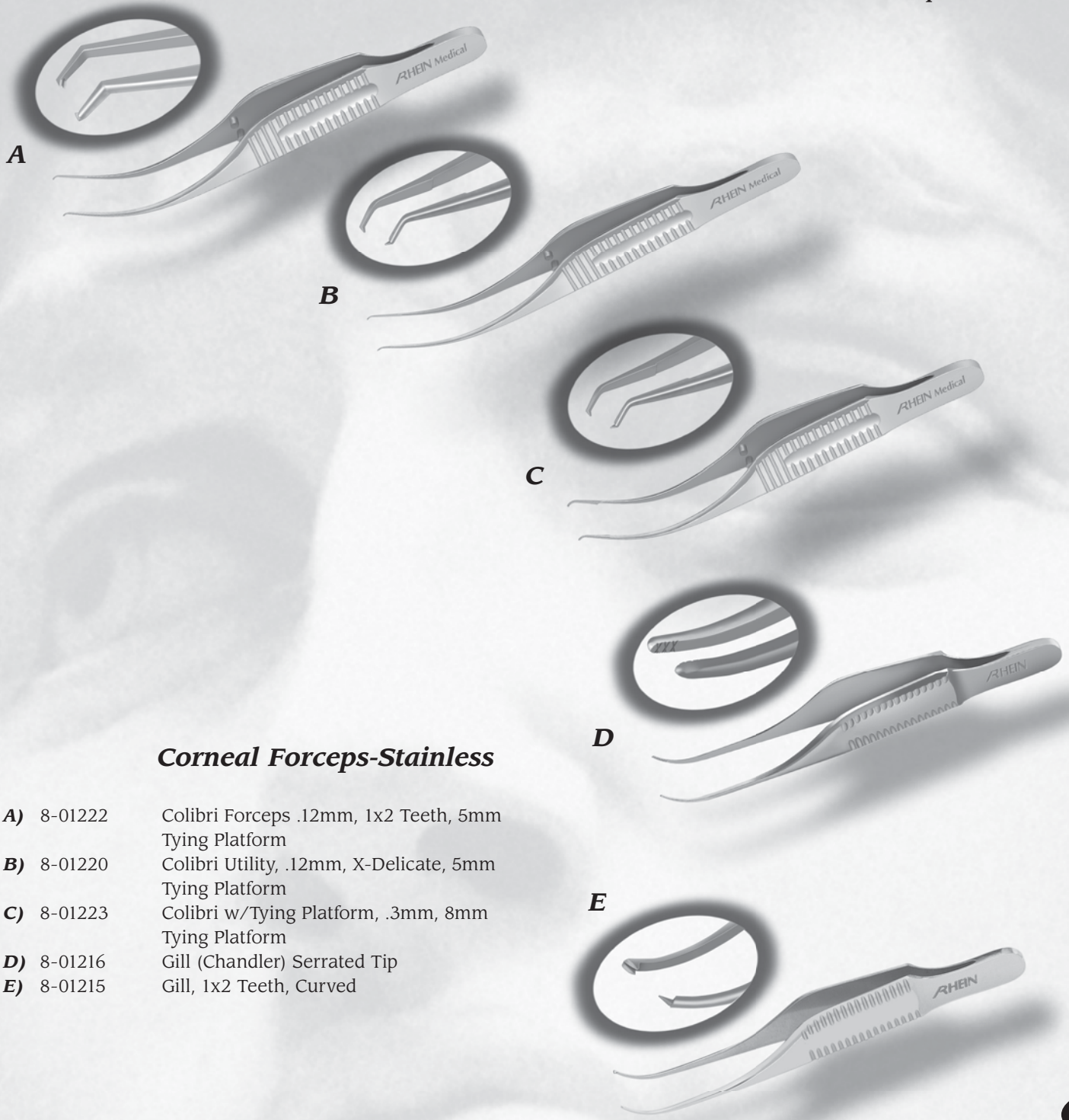

Corneal Forceps-Stainless

- A)** 8-01222 Colibri Forceps .12mm, 1x2 Teeth, 5mm Tying Platform
- B)** 8-01220 Colibri Utility, .12mm, X-Delicate, 5mm Tying Platform
- C)** 8-01223 Colibri w/Tying Platform, .3mm, 8mm Tying Platform
- D)** 8-01216 Gill (Chandler) Serrated Tip
- E)** 8-01215 Gill, 1x2 Teeth, Curved

13.13



ELEVATING THE QUALITY



1-800-263-3557



FORCEPS

Corneal Forceps-Stainless

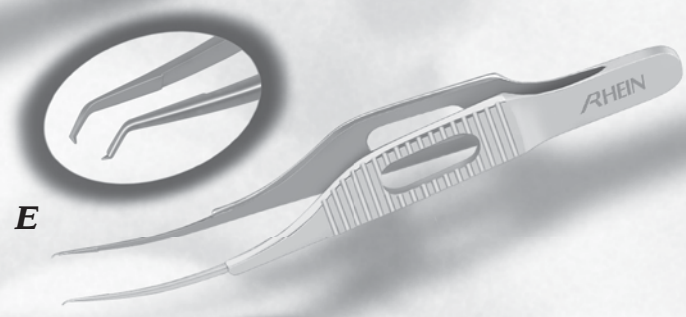
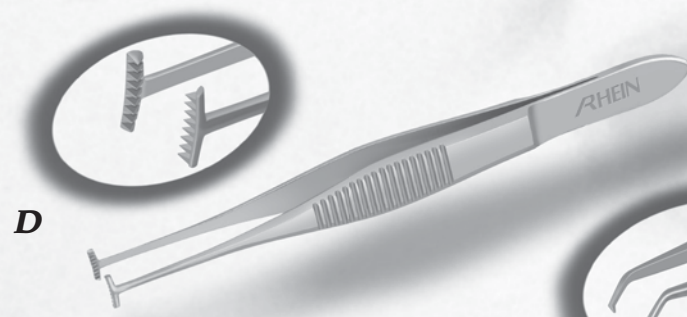
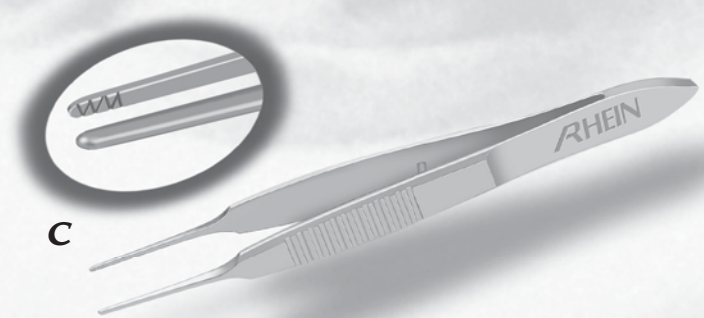
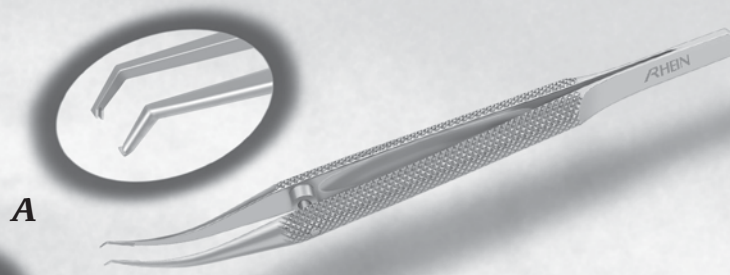

Corneal Forceps-Stainless

- A)** 8-01243 Girard Corneo-Scleral, .12mm 1x2 Teeth
- B)** 8-01206 Graefe Iris, 1x2 Teeth, Straight
- 8-01207 Graefe Iris, 1x2 Teeth, Curved
- C)** 8-01208 Graefe Iris, Serrated Tip, Straight
- 8-01209 Graefe Iris, Serrated Tip, Curved
- D)** 8-01291 Green Fixation, 5mm Jaws 8x9 Teeth
- E)** 8-01221 Harms Colibri Forceps - .12mm w/Tying Platforms
- F)** 8-01231 Elschmig, 1x2 Teeth, Straight

13.14



ELEVATING THE QUALITY OF CARE IN OPHTHALMOLOGY
800-637-4346



1-800-263-3557

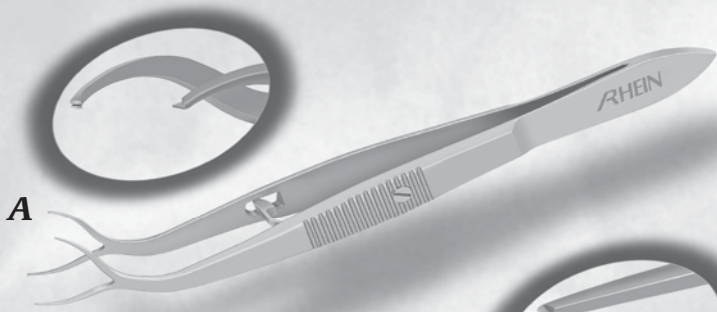

A

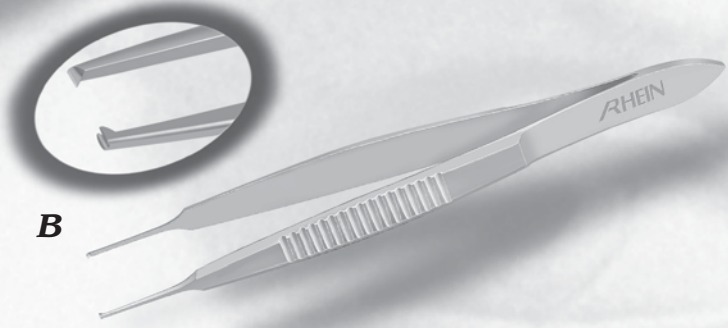

B

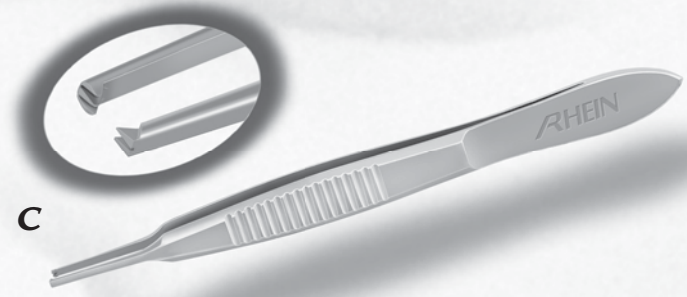

C



D

Corneal Forceps-Stainless

- A)** 8-01285 Kremer Fixation Forceps 1x2, .12mm Curved
- 8-01284 Kremer Fixation Forceps 1x2, .12mm Straight
- B)** 8-01294 Lester Fixation 1x2 Teeth
- C)** 8-01295 Lester Fixation 2x3 Teeth
- D)** 8-01270 Maumenee Colibri .12mm 1x2 Teeth 5mm Tying Platform



FORCEPS

Corneal Forceps-Stainless

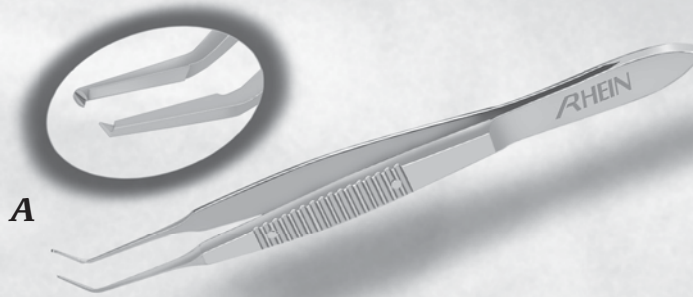

A

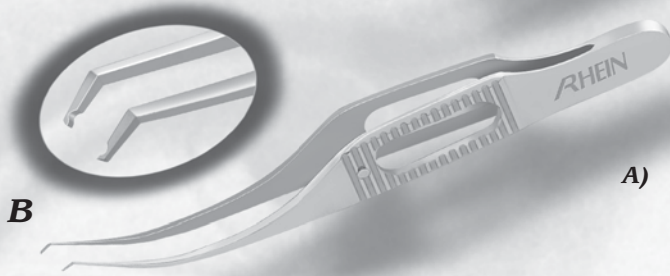

B



C

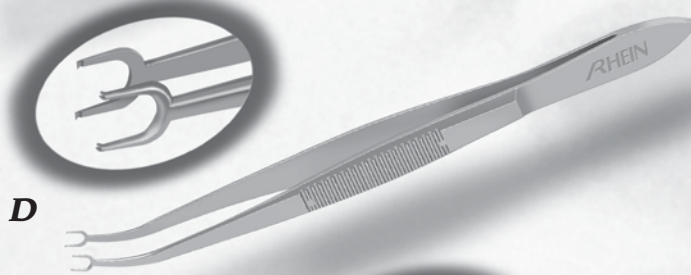

D

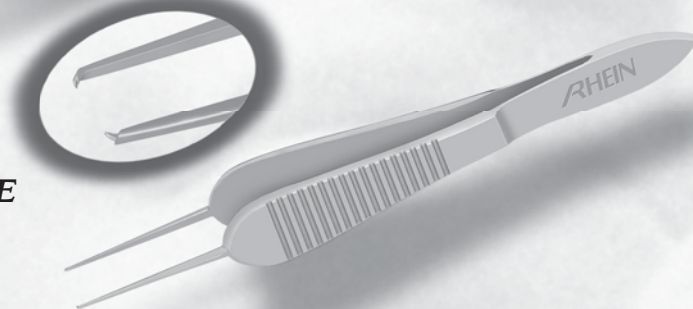

E

Corneal Forceps-Stainless

- A)** 8-01218 McPherson, 1x2 .12mm Teeth, Angled 5mm Tying Platforms
- 8-01219 Kelman/McPherson, 1x2 .12mm Teeth, Angled 8mm Tying Platforms
- 8-01217 McPherson, 1x2 .12mm Teeth, Straight 5mm Tying Platforms
- B)** 8-01224 Pierse Colibri, .1mm Teeth
- 8-01225 Pierse Colibri, .3mm Teeth
- C)** 8-01261 Polack, Double .12mm Corneal Fixation
- 8-01262 Polack, Double Corneal Fixation
- Pierse .1mm
- D)** 8-01281 Rubman-Bores Fixation Forceps, 1x2, .12mm Curved
- E)** 8-01271 Sauer Suturing Forceps, .6mm Teeth

13.16



ELEVATING THE QUALITY OF CARE IN OPHTHALMOLOGY
800-637-4346



1-800-263-3557

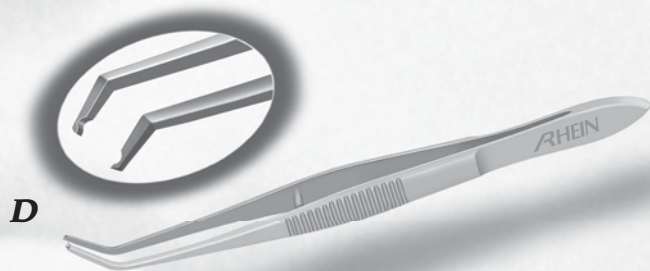
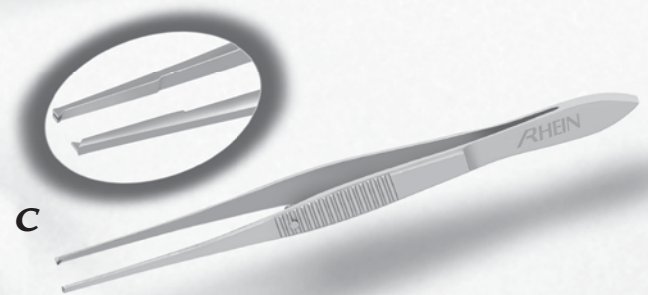
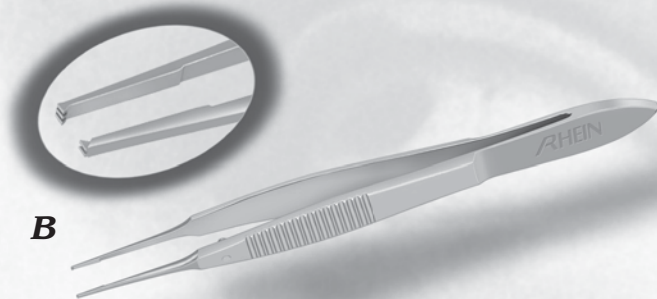

Corneal Forceps-Stainless

- A)** 8-01298 Tennant Superior Rectus Forceps, Curved
- B)** 8-01239 Thorpe Corneal Forceps, 2x3 Teeth, 5mm Tying Platform
- C)** 8-01234 Tissue, Delicate, 1x2 Teeth, Straight
 8-01235 Tissue, Delicate, 1x2 Teeth, Slight Curve
- D)** 8-01299 Troutman Superior Rectus Forceps

13.17



ELEVATING THE QUALITY



ACOR

1-800-263-3557



FORCEPS

Corneal Forceps-Titanium

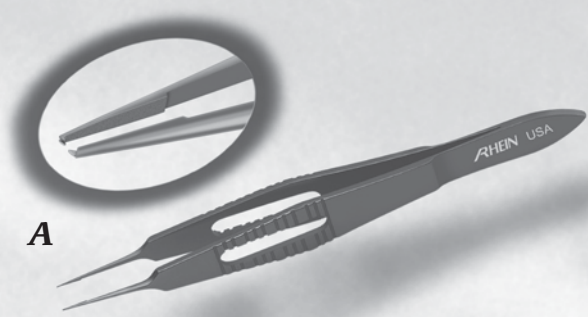

A

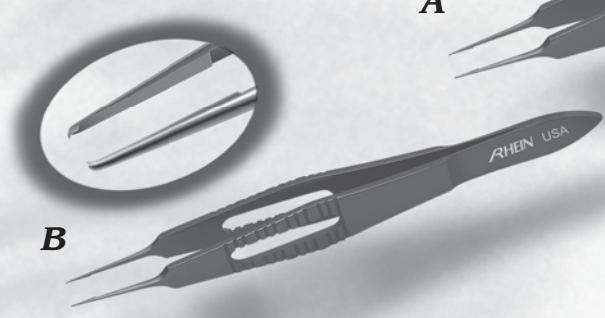

B

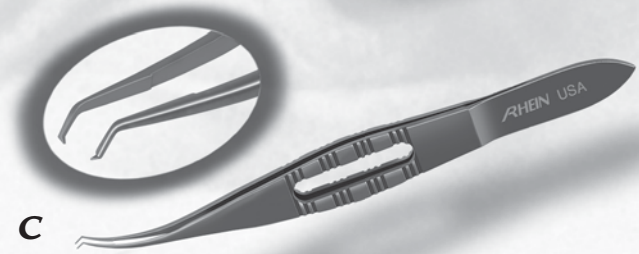

C

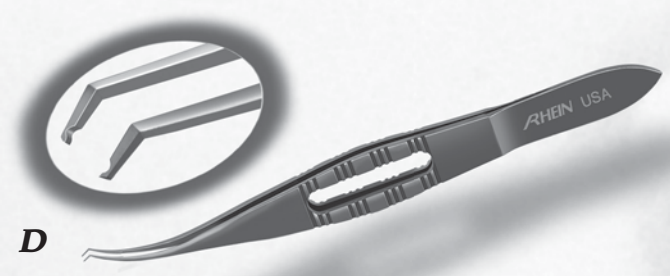

D

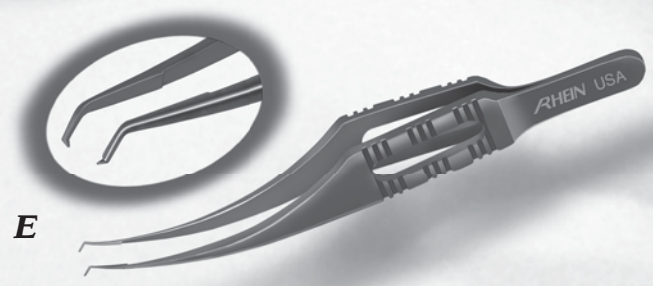

E

Corneal Forceps-Titanium

- A)** 05-2216 Bonn, Straight, 1x2 Teeth, .12mm, w/5mm Tying Platform, 4"-Titanium
- 05-2217 Bonn, Curved, 1x2 Teeth, .12mm, w/5mm Tying Platform, 3-3/8"-Titanium
- 05-2215 Bonn, Straight, 1x2 Teeth, .12mm, w/Platform, 3-3/8"-Titanium
- B)** 05-2220 Castroviejo, Straight, 1x2 Teeth, .12mm, w/4mm Tying Platform, 4"-Titanium
- 05-2221 Castroviejo, Straight, 1x2 Teeth, .3mm, w/Platform, 4"-Titanium
- C)** 05-2225 Colibri, .12mm Teeth, w/Platform, 3-3/8"-Titanium
- 05-2226 Colibri, .12mm Teeth, w/ 5mm Tying Platform, 4"-Titanium
- D)** 05-2224 Colibri, Pierse Teeth, w/5mm Tying Platform, 3-3/8"-Titanium
- E)** 05-2229 Colibri, Troutman/Barraquer, .12 Teeth, w/Platform, 3"-Titanium

13.18



ELEVATING THE QUALITY OF CARE IN OPHTHALMOLOGY
800-637-4346



1-800-263-3557

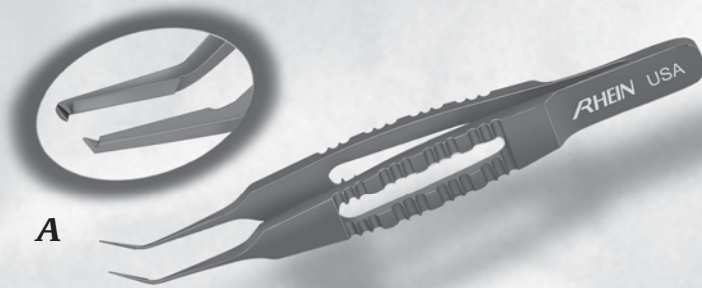

A

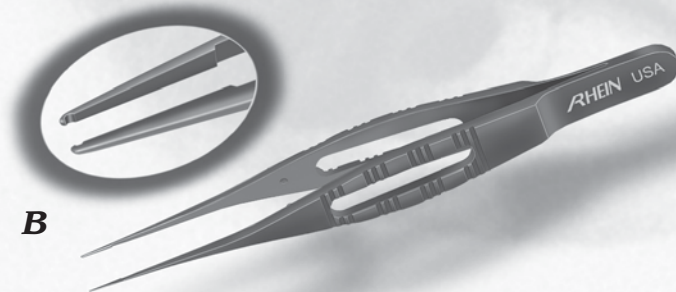

B

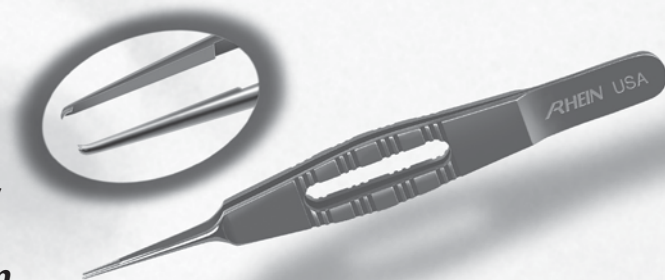

C

Corneal Forceps-Titanium

- A)** 05-2232 McPherson, Angled, .12mm Teeth, w/Platform, 3-3/8"-Titanium
- B)** 05-2211 Pierse Type, Straight, w/Platform, 3-3/8"-Titanium
- 05-2212 Pierse Type, Curved, w/Platform, 3-3/8"-Titanium
- C)** 05-2218 Rhein, Straight, 45 Degree 1x2 Teeth, .12mm, 3-3/8"-Titanium, 5mm Tying Platform

13.19



ELEVATING THE QUALITY



1-800-263-3557



FORCEPS

Dressing Forceps

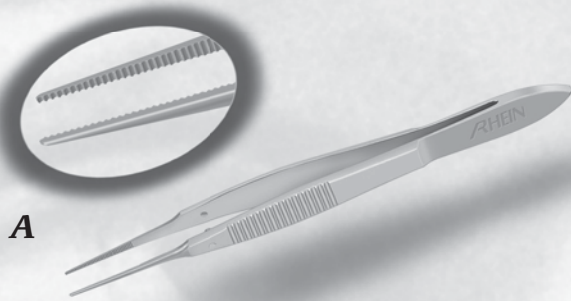

A

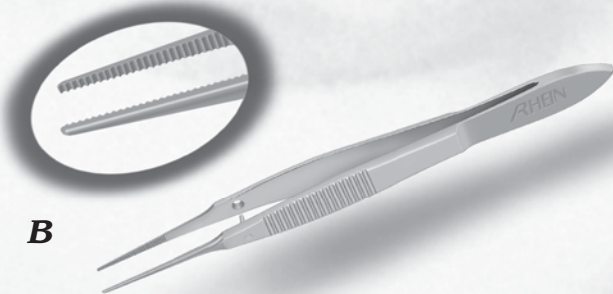

B

Dressing Forceps

- | | | |
|-----------|---------|-------------------------------------|
| A) | 8-01501 | Dressing Forceps Delicate, Straight |
| | 8-01502 | Dressing Forceps Delicate, Curved |
| B) | 8-01504 | Dressing Forceps Standard, Straight |
| | 8-01505 | Dressing Forceps Standard, Curved |



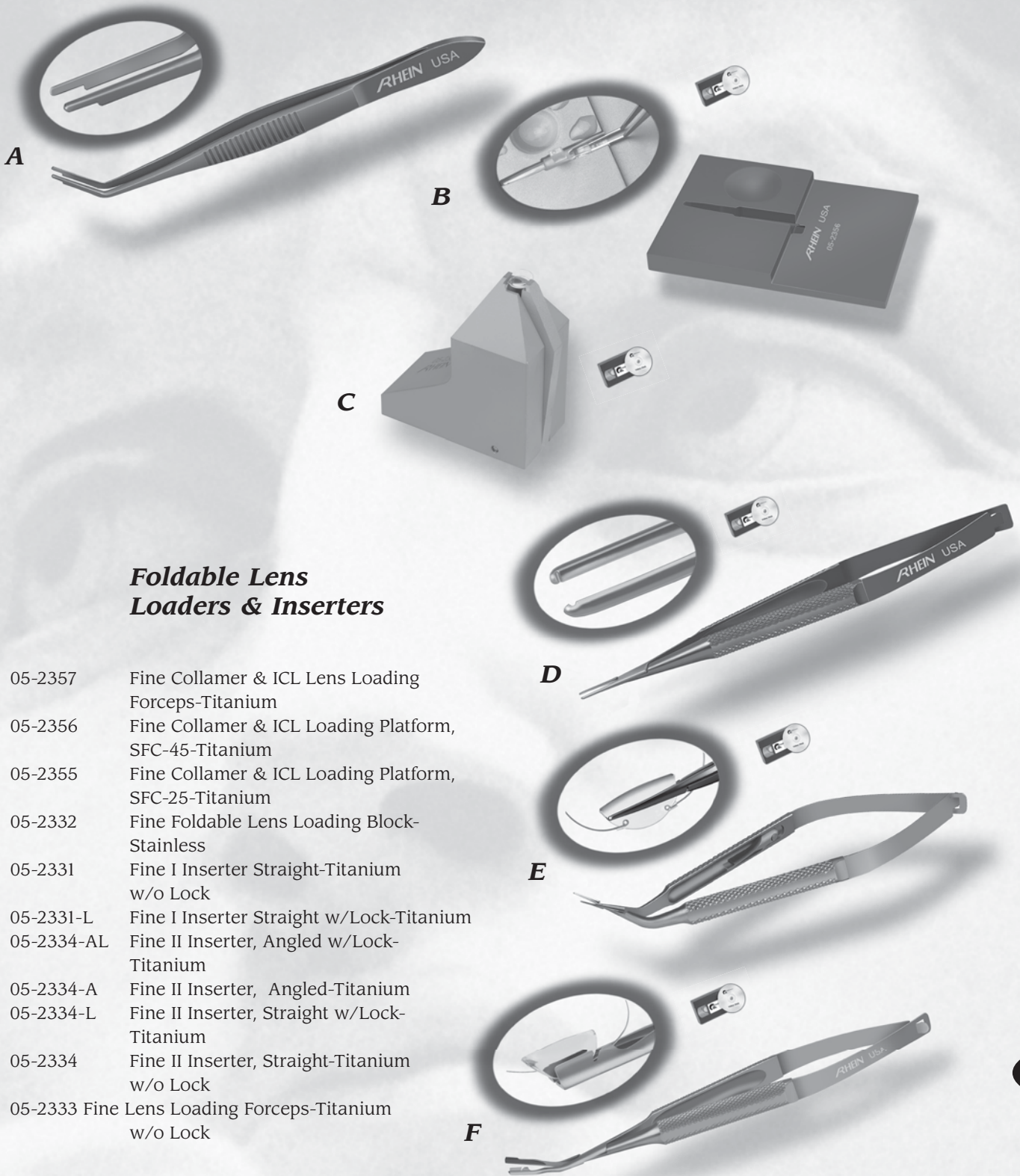

Foldable Lens Loaders & Inserters

- A)** 05-2357 Fine Collamer & ICL Lens Loading Forceps-Titanium
- B)** 05-2356 Fine Collamer & ICL Loading Platform, SFC-45-Titanium
- 05-2355 Fine Collamer & ICL Loading Platform, SFC-25-Titanium
- C)** 05-2332 Fine Foldable Lens Loading Block-Stainless
- D)** 05-2331 Fine I Inserter Straight-Titanium w/o Lock
- 05-2331-L Fine I Inserter Straight w/Lock-Titanium
- E)** 05-2334-AL Fine II Inserter, Angled w/Lock-Titanium
- 05-2334-A Fine II Inserter, Angled-Titanium
- 05-2334-L Fine II Inserter, Straight w/Lock-Titanium
- 05-2334 Fine II Inserter, Straight-Titanium w/o Lock
- F)** 05-2333 Fine Lens Loading Forceps-Titanium w/o Lock

13.21



ELEVATING THE QUALITY



1-800-263-3557



FORCEPS

Foldable Lens Loaders & Inserters

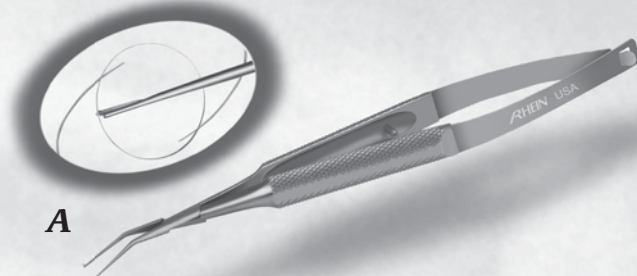

A

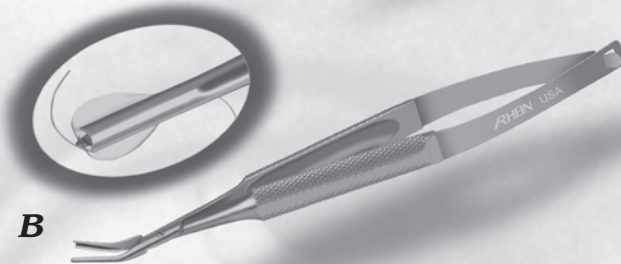

B

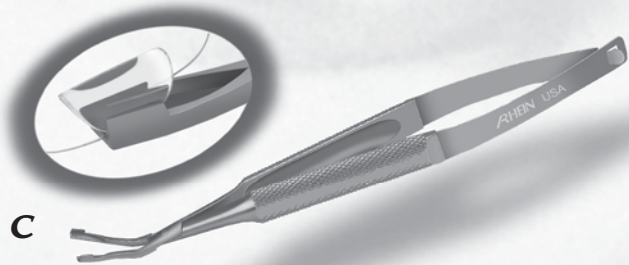

C

Foldable Lens Loaders & Inserters

- A) 05-2410 Hess Memory Lens Inserter-Titanium
- B) 05-2400 Kellan Inserter-Titanium
- C) 05-2402 Lehner I Loader-Titanium
- D) 05-2377 Lehner II Acrylic Lens Inserter-Titanium w/Lock
- E) 05-2376 Lehner II Acrylic Lens Loader-Titanium



D

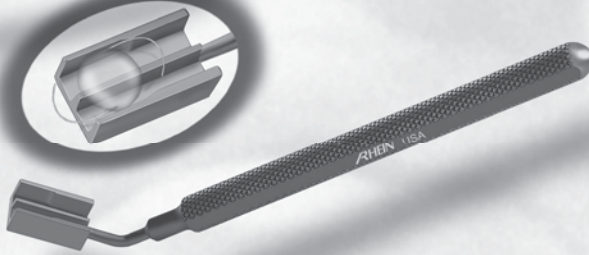

E

13.22



ELEVATING THE QUALITY OF CARE IN OPHTHALMOLOGY
800-637-4346



1-800-263-3557

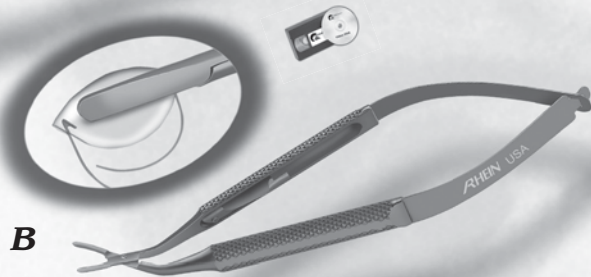

**Foldable Lens
 Loaders & Inserters**

- A)** 05-2375 Lindstrom Lens Inserter - Titanium
- B)** 05-2344 Nichamin I Foldable Lens Insertion Forceps-Titanium w/Lock
- C)** 05-2342 Nichamin I Foldable Lens Loading Forceps-Titanium
- D)** 05-2348 Nichamin II Foldable Lens Insertion Forceps-Titanium w/Lock

13.23



ELEVATING THE QUALITY



1-800-263-3557



FORCEPS

Foldable Lens Loaders & Inserters

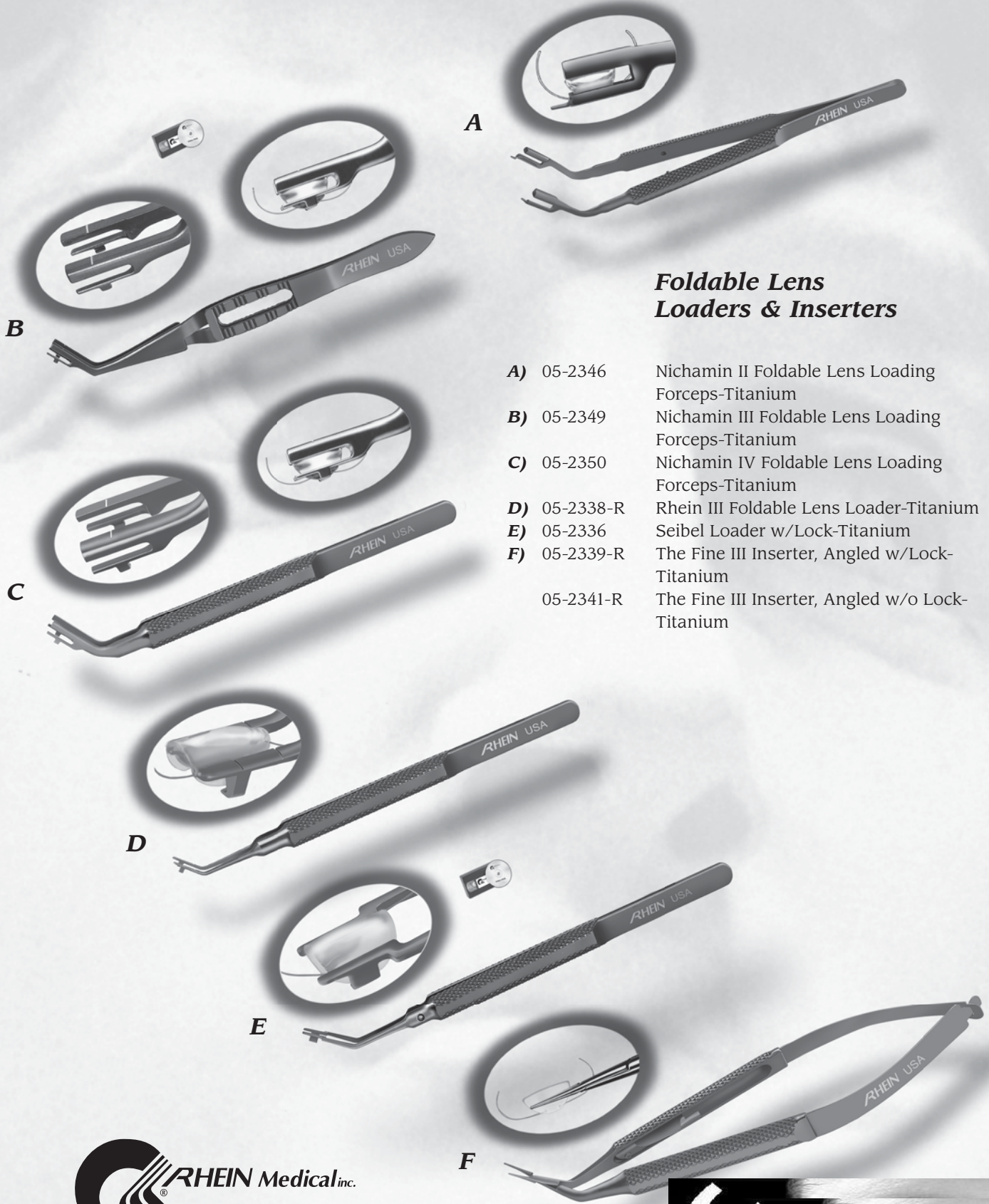

Foldable Lens Loaders & Inserters

- A) 05-2346 Nichamin II Foldable Lens Loading Forceps-Titanium
- B) 05-2349 Nichamin III Foldable Lens Loading Forceps-Titanium
- C) 05-2350 Nichamin IV Foldable Lens Loading Forceps-Titanium
- D) 05-2338-R Rhein III Foldable Lens Loader-Titanium
- E) 05-2336 Seibel Loader w/Lock-Titanium
- F) 05-2339-R The Fine III Inserter, Angled w/Lock-Titanium
- 05-2341-R The Fine III Inserter, Angled w/o Lock-Titanium

13.24



ELEVATING THE QUALITY OF CARE IN OPHTHALMOLOGY
800-637-4346



1-800-263-3557

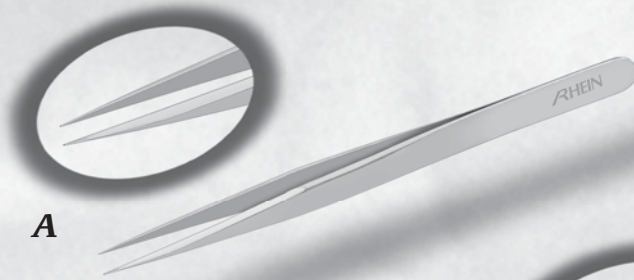

A

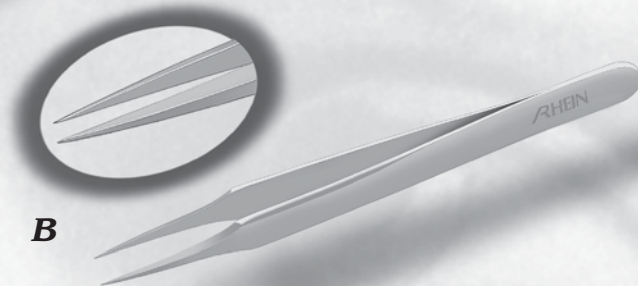

B

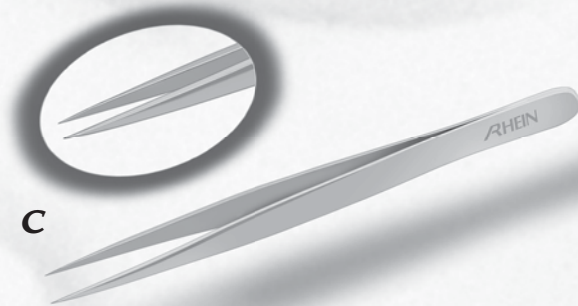

C

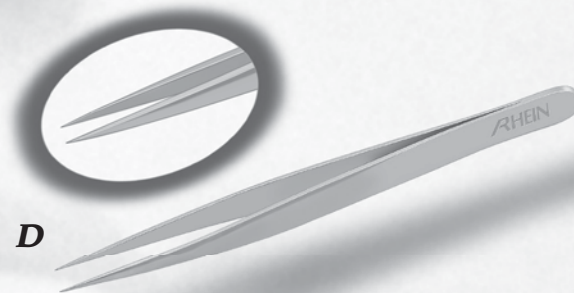

D

Jeweler Forceps

- A)** 8-01603 Jeweler Forceps, #1, Straight
- B)** 8-01604 Jeweler Forceps, #2, Straight
- C)** 8-01605 Jeweler Forceps, #3, Straight
- D)** 8-01606 Jeweler Forceps, #3C, Straight

13.25



ELEVATING THE QUALITY



1-800-263-3557



FORCEPS

Jeweler Forceps

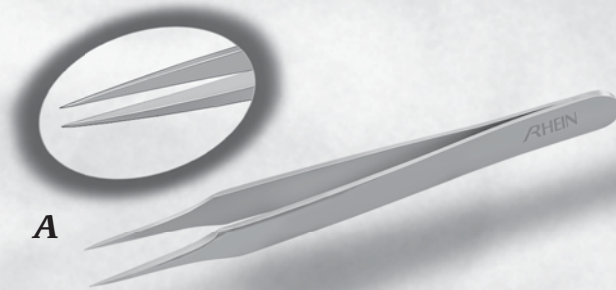

A

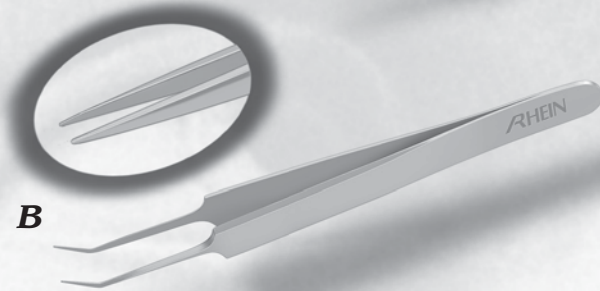

B

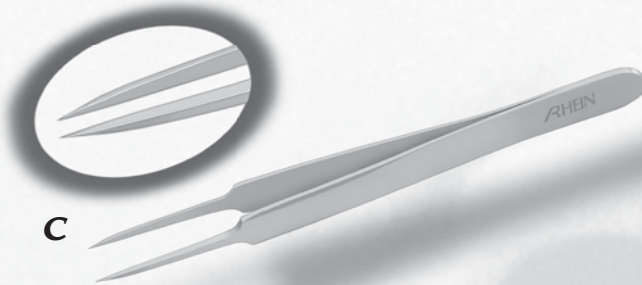

C



D

Jeweler Forceps

- A)** 8-01607 Jeweler Forceps, #4, Straight
- B)** 8-01611 Jeweler Forceps, #5, Angled 45 Degrees
- C)** 8-01608 Jeweler Forceps, #5, Straight
- D)** 8-01609 Jeweler Forceps, #7, Curved

13.26



ELEVATING THE QUALITY OF CARE IN OPHTHALMOLOGY
800-637-4346



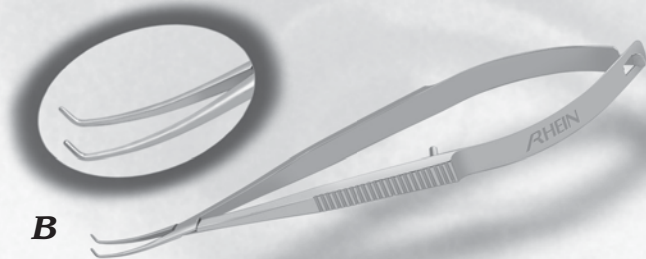
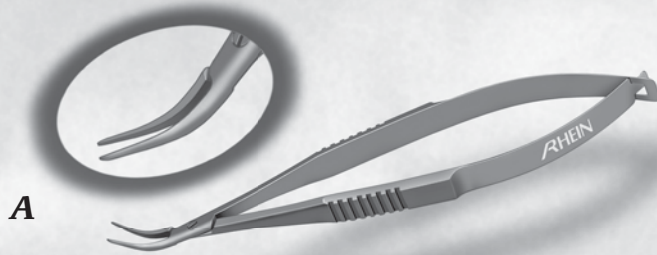

Lens Forceps

- A)** 05-2314 Blaydes Lens Insertion Forceps, Titanium
 8-01315 Blaydes Lens Insertion Forceps
- B)** 8-01322 Clayman Lens Forceps w/o Lock
 8-01323 Clayman Lens Forceps w/Lock
- C)** 05-2313 Clayman Lens Insertion Forceps-Titanium
- D)** 8-01335 Faulkner Lens Insertion Forceps X-Action

13.27



ELEVATING THE QUALITY



1-800-263-3557

FORCEPS

Lens Forceps

A

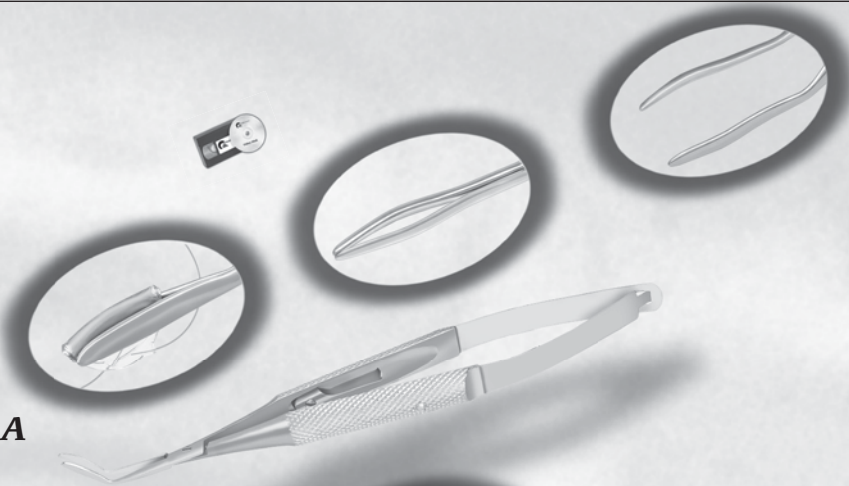

B



C

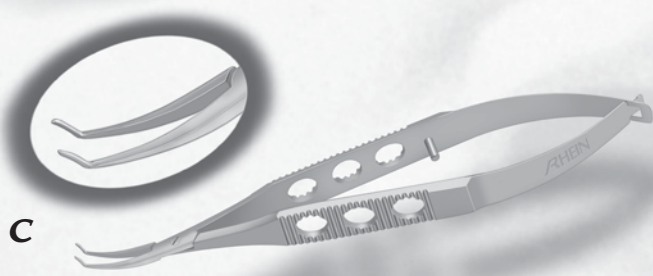

D



Lens Forceps

- A) 8-01336 Fine Foldable Lens Insertion Forceps
- B) 8-01338 Kershner Foldable Lens Insertion Forceps
- C) 8-01318 Kraff Lens Insertion Forceps
- D) 8-01380 Lehner I Lens Inserter

13.28



ELEVATING THE QUALITY OF CARE IN OPHTHALMOLOGY
800-637-4346



1-800-263-3557

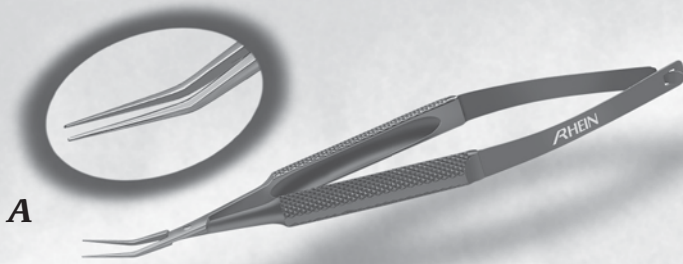

Lens Forceps

- A)** 05-2325 Lindstrom Lens Insertion Forceps w/Notch-Titanium
- 05-2330 Lindstrom Lens Insertion Forceps w/o Notch-Titanium
- B)** 05-2311 Rhein Universal Lens Insertion Forceps-Titanium
- C)** 05-2340 Rhein Cross Action Pierce Tooth Lens Forceps-Titanium
- D)** 8-01390 Serdarevic Lens Inserter

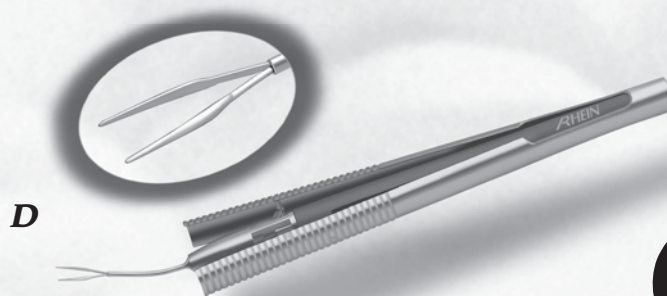
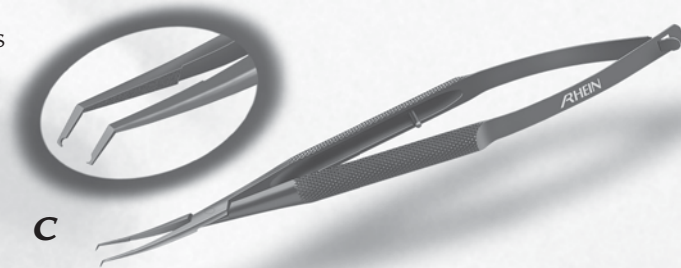

13.29



1-800-263-3557

FORCEPS

Lens Forceps

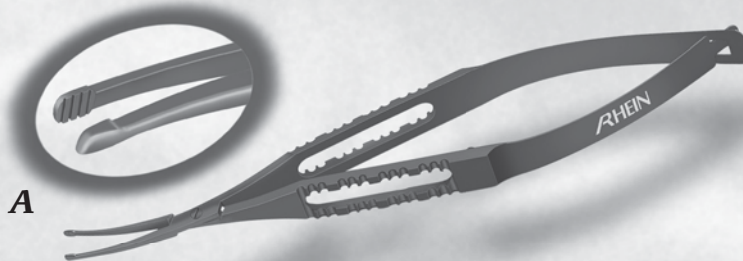

A

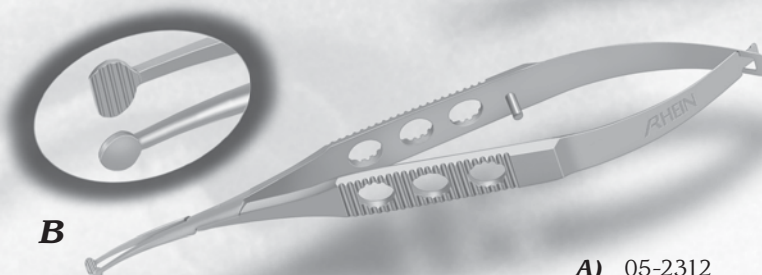

B



C

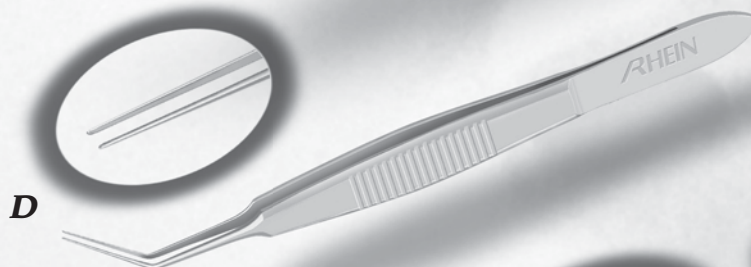

D

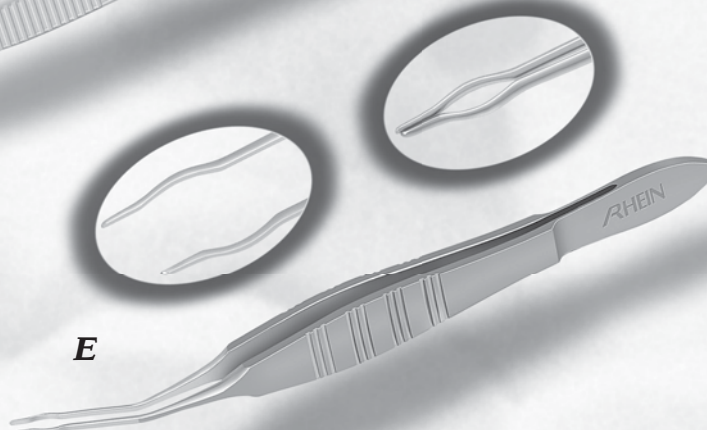

E

Lens Forceps

- A)** 05-2312 Shepard Lens Insertion Forceps-Titanium
- B)** 8-01325 Shepard Lens Insertion Forceps w/Notch-Titanium
- C)** 8-01340 Dusek-McIntyre Forceps
- D)** 8-01397 Rhein ICL Retrieval Forceps, 12mm Blades, Angled Jaws
- E)** 8-01398 Rhein Crystalens Lens Insertion Forceps

13.30



ELEVATING THE QUALITY OF CARE IN OPHTHALMOLOGY
800-637-4346





A

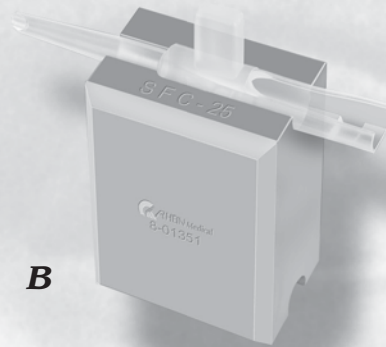

B

Lens Forceps

- A)** 8-01350 Fine Collamer & ICL Lens Loading Forceps
- B)** 8-01351 Collamer & ICL Cartridge Loading Block
- C)** 8-01396 Vukich Loading Forceps, Direct Acting
- D)** 8-01352 Vukich Collamer & ICL Cartridge Loading Forceps, Cross Acting



C

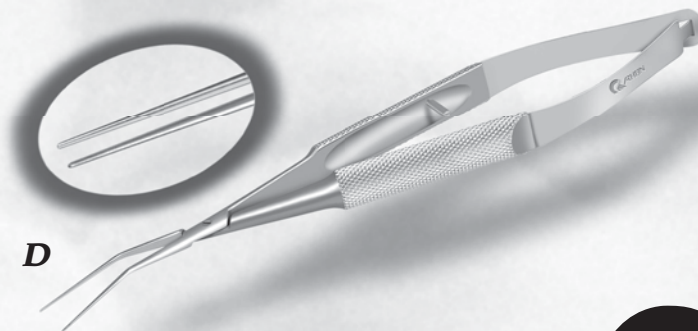

D

13.31



ELEVATING THE QUALITY



1-800-263-3557

FORCEPS

Lens Forceps

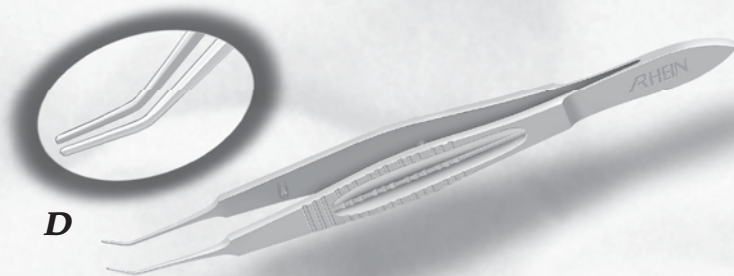
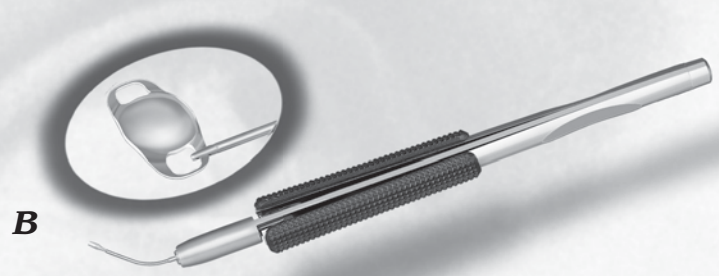
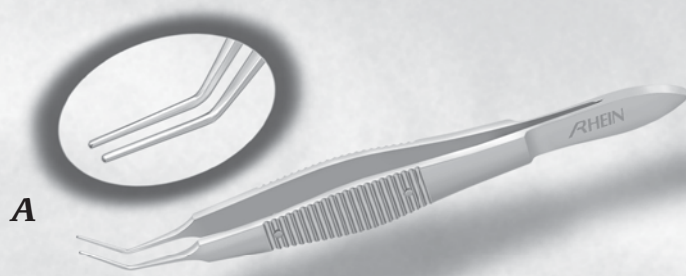

Lens Forceps

- A)** 8-01337 Faulkner Lens Holder
- B)** 8-01392-D Rhein Artisan Lens Holding Forceps, Direct Acting, 22g
- 8-01392-R Rhein Artisan Lens Holding Forceps, Reverse Acting
- C)** 8-01334 Rhein I Lens Holding Forceps
- D)** 8-01339 Rhein II Lens Holding Forceps



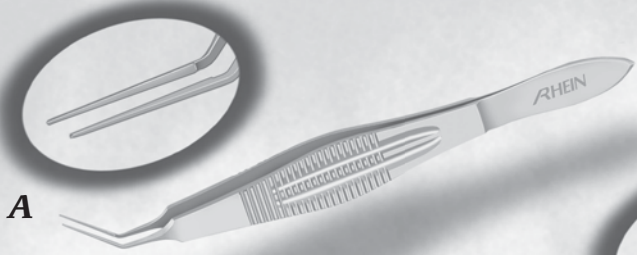

A

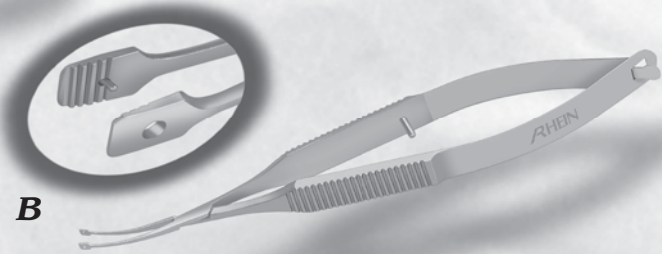

B

Lens Forceps

- A)** 8-01345 Gaskin Fragment Forceps
- B)** 8-01310 Knolle/Shepard w/Peg, Serrated Jaws
- C)** 8-01341 Utrata Foldable Lens Retriever
- D)** 8-01347 Stolte Hawksbill Pre-Chopper, Angled Handle
- E)** 8-01346-A Stolte Pre-Chopper, Angled Handle, Straight Blades
- F)** 8-01346-S Stolte Pre-Chopper, Straight Handle, Straight Blades

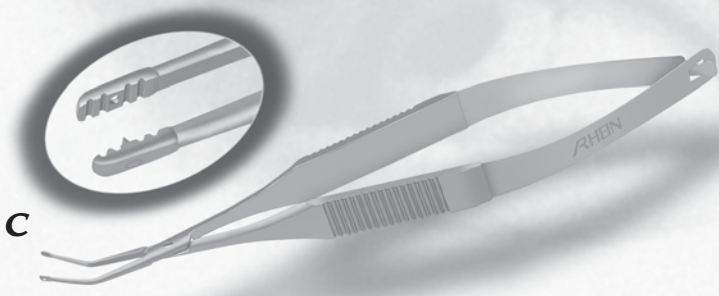

C

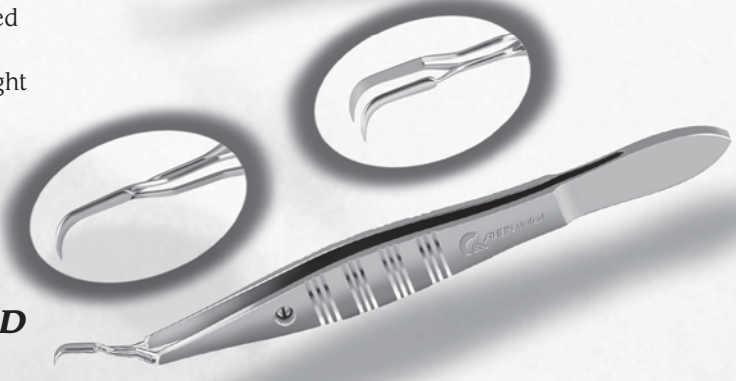

D

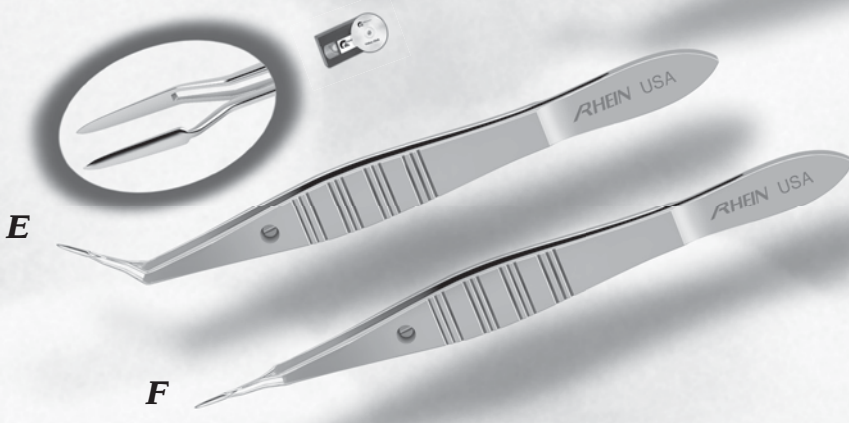

E

F

13.33



FORCEPS

Miscellaneous

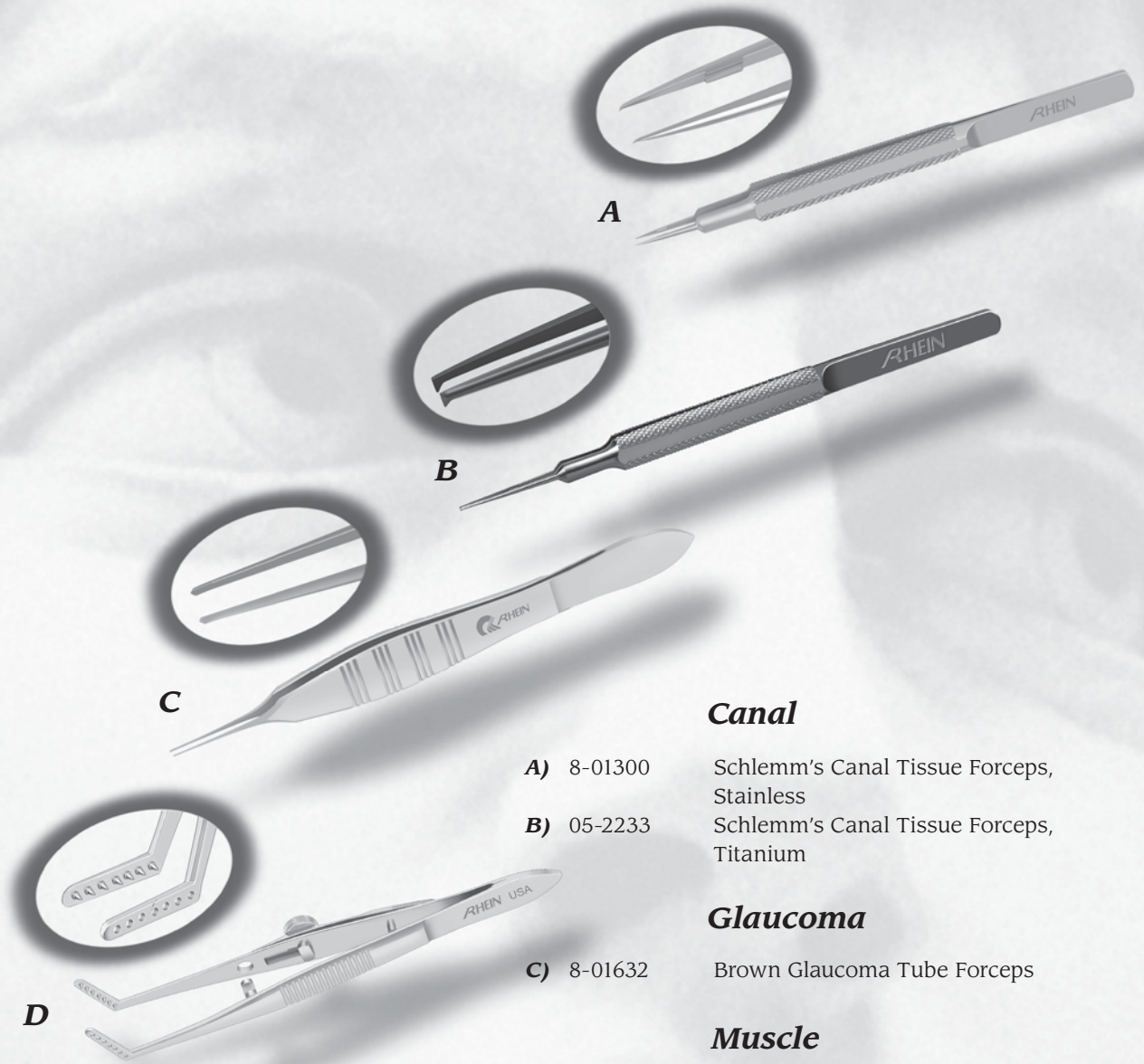

Canal

- A) 8-01300 Schlemm's Canal Tissue Forceps, Stainless
- B) 05-2233 Schlemm's Canal Tissue Forceps, Titanium

Glaucoma

- C) 8-01632 Brown Glaucoma Tube Forceps

Muscle

- D) 8-01630 Jameson Muscle Forceps, Left w/Lock
- 8-01631 Jameson Muscle Forceps, Right w/Lock

13.34



ELEVATING THE QUALITY OF CARE IN OPHTHALMOLOGY
800-637-4346



1-800-263-3557

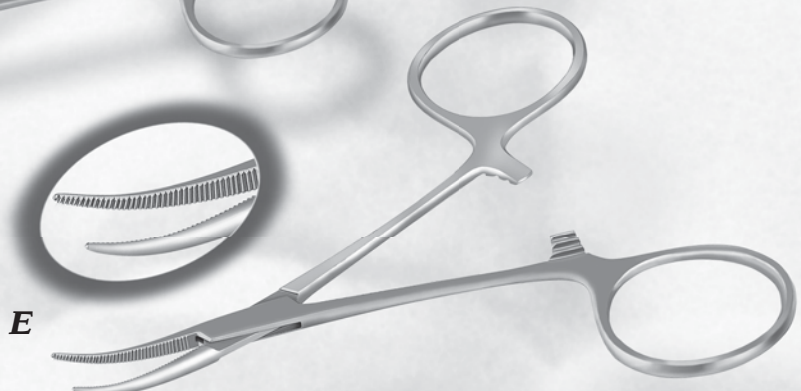
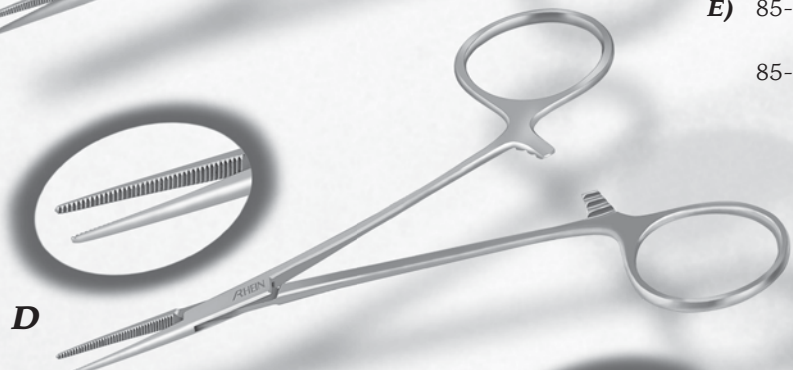
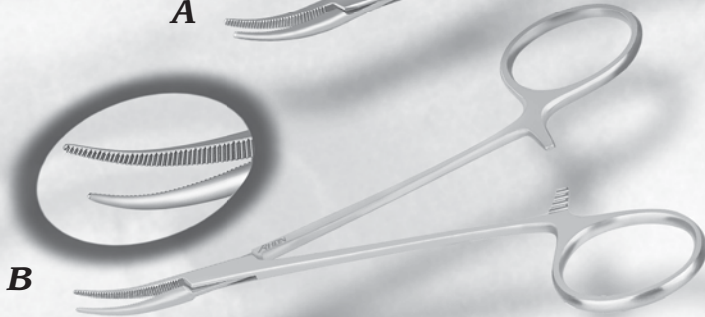
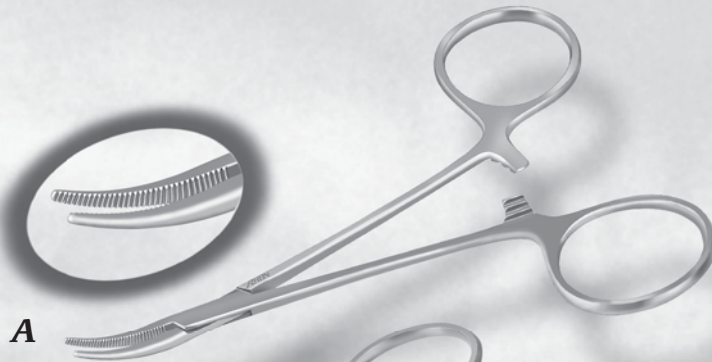

Mosquito Forceps

- A)** 85-5024 Halsted Mosquito Forceps, 5", Curved Standard
- B)** 85-5026 Halsted Mosquito Forceps, 5", Curved X-Delicate
- C)** 85-5023 Halsted Mosquito Forceps, 5", Straight Standard
- D)** 85-5025 Halsted Mosquito Forceps, 5", Straight X-Delicate
- E)** 85-5019 Hartman Mosquito Forceps, 3-1/2" Curved
- 85-5018 Hartman Mosquito Forceps, 3-1/2" Straight

13.35



ELEVATING THE QUALITY



1-800-263-3557



FORCEPS

Nucleus Splitting Forceps and Serrefine Forceps

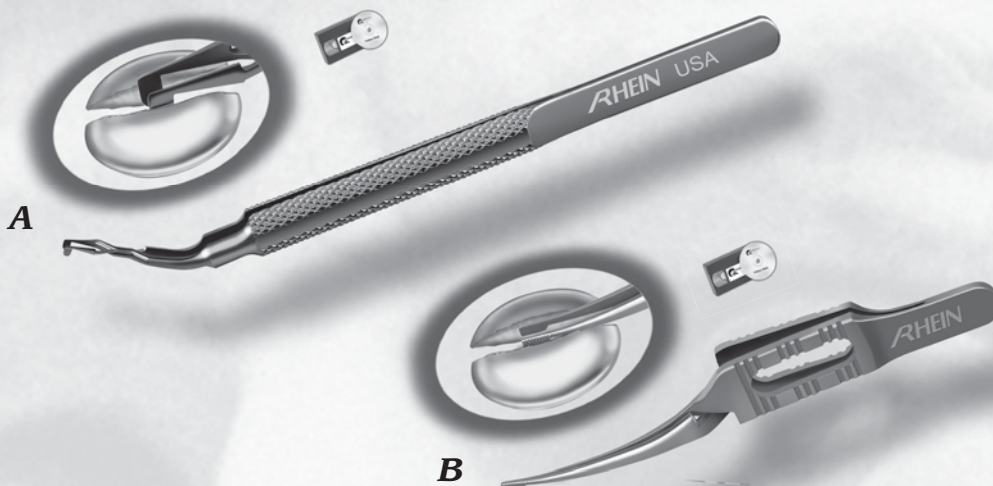

Nucleus Splitting Forceps

- A) 05-2351 Koch-Salz Nucleus Splitter-Titanium
- B) 05-2335 Salz Nucleus Splitter-Titanium

Serrefine Forceps

- C) 8-13110 Serrefine 1-1/2", Curved With Suture Hole
- 8-13111 Serrefine 2-1/2", Curved With Suture Hole
- D) 8-13108 Serrefine 1-1/2", Straight With Suture Hole
- 8-13109 Serrefine 2-1/2", Straight With Suture Hole

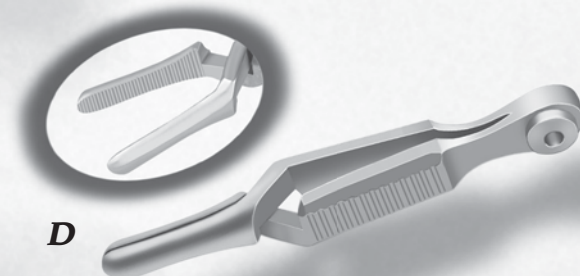
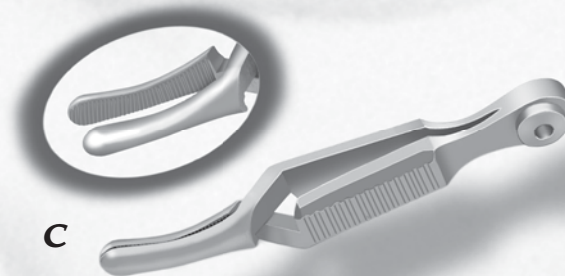

FORCEPS

Tying Forceps-Stainless

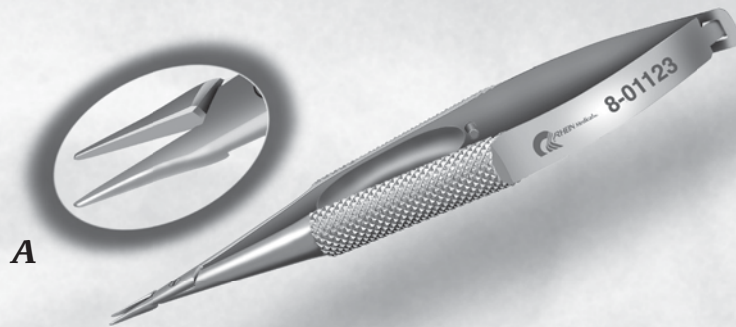

A

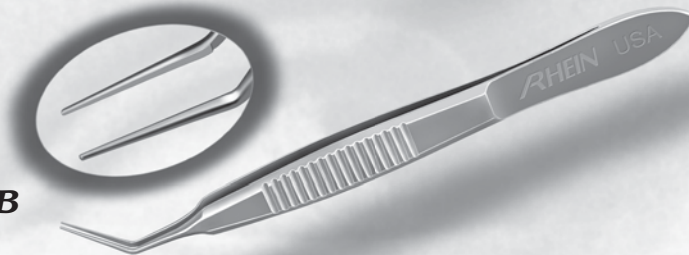

B



C

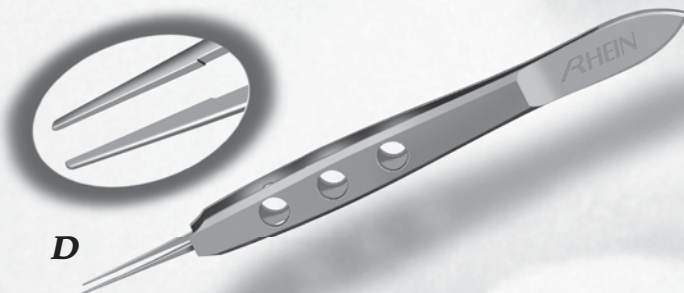

D

Tying Forceps-Stainless

- A)** 8-01123 Anis Tying Forceps, Straight, Round Handle
- 8-01122 Anis Tying Forceps, Curved, Round Handle
- B)** 8-01116 Bechert/McPherson Tying Forceps Angled 10mm Tying Platforms
- C)** 8-01108 Harms Tying Forceps, Straight 7mm Tying Platforms
- 8-01109 Harms Tying Forceps, Curved 7mm Tying Platforms
- D)** 8-01110 Jaffe Tying Forceps, Straight 6mm Tying Platforms
- 8-01111 Jaffe Tying Forceps, Curved 6mm Tying Platforms

13.37



ELEVATING THE QUALITY



1-800-263-3557



FORCEPS

Tying Forceps-Stainless

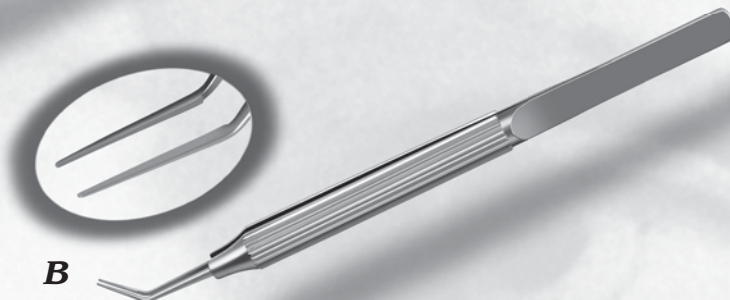
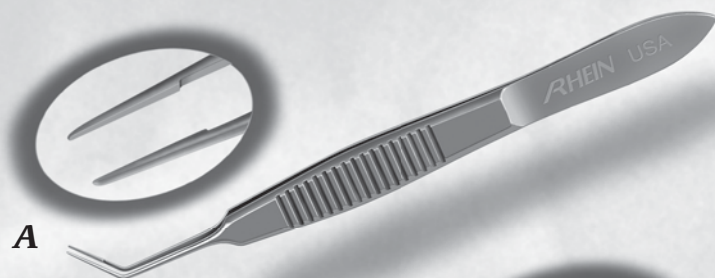

Tying Forceps-Stainless

- A) 8-01102 Kelman/McPherson, Angled 8mm Tying Platforms
- B) 8-01103 Kelman/McPherson, Round Handle, Angled 8mm Tying Platforms
- C) 8-01107 McPherson, Angled, Micro 5mm Tying Platforms
- 8-01106 McPherson, Straight, Micro 5mm Tying Platforms
- D) 8-01124 Pfister PKP Suture Adjustment Forceps & Spatula

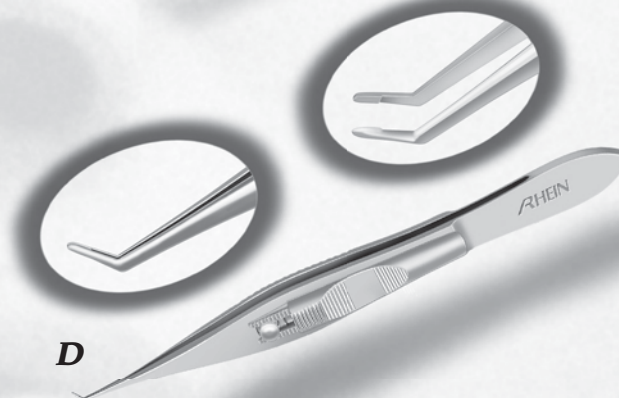
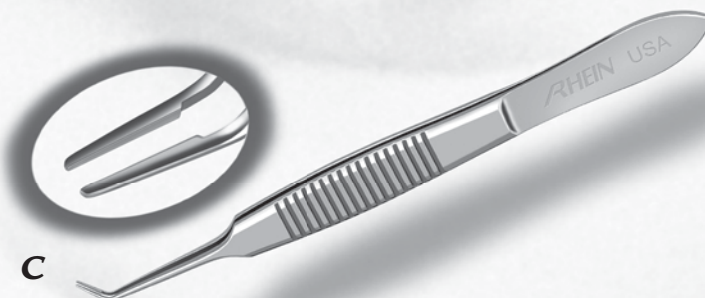

13.38



ELEVATING THE QUALITY OF CARE IN OPHTHALMOLOGY
800-637-4346



FORCEPS

Tying Forceps-Stainless

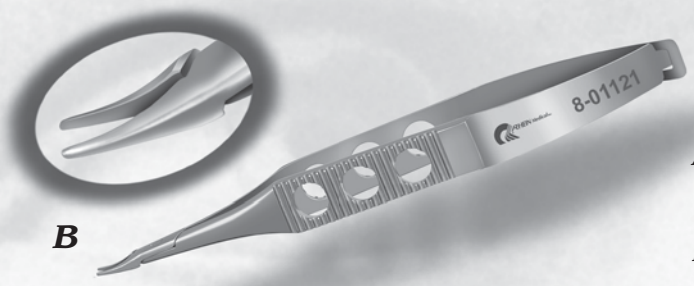
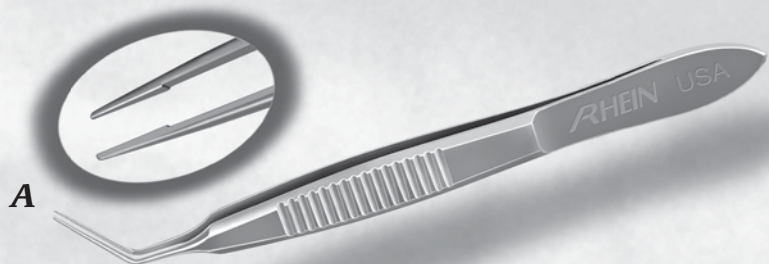

B

- A)** 8-01101
- B)** 8-01121
8-01120
- C)** 8-01115
- D)** 8-01114

Tying Forceps-Stainless

Sheets McPherson Forceps,
Angled Tying 10.5mm Platforms
w/1mm Tip Of Cross Serrations
Sinskey Tying Forceps, Curved
Sinskey Tying Forceps, Straight
Tennant Tying Forceps, Curved 6mm
Tying Platforms
Tennant Tying Forceps, Straight 6mm
Tying Platforms

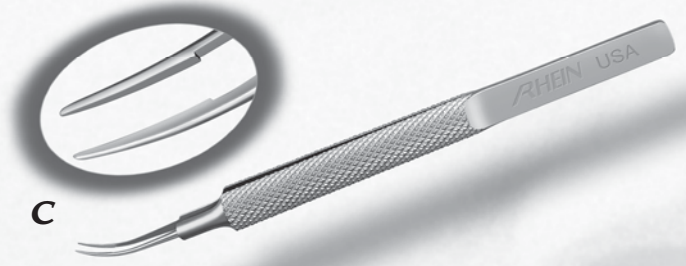

C

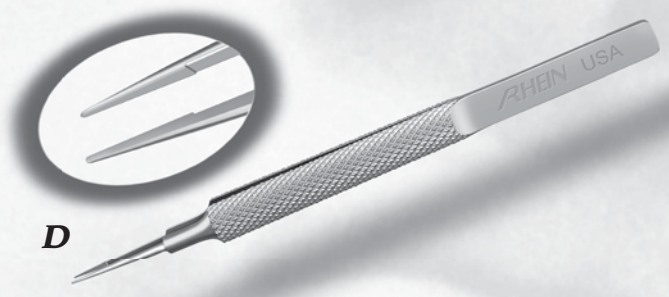

D

13.39



1-800-263-3557

FORCEPS
Tying Forceps-Titanium

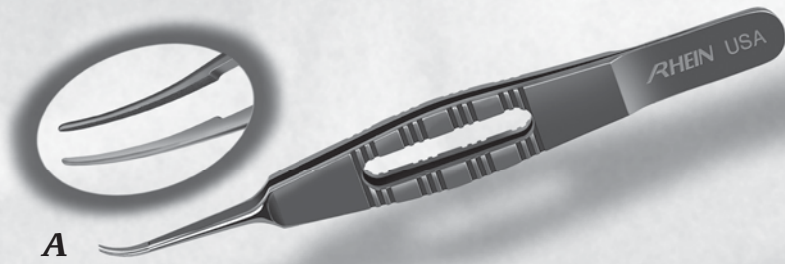

A

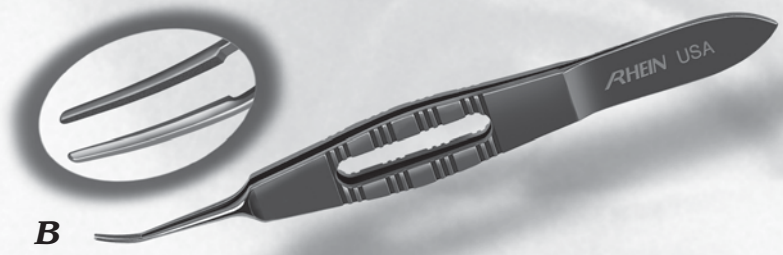

B

Tying Forceps-Titanium

- A)** 05-2112 Curved, 3-3/8"-Titanium
- B)** 05-2116 Curved, 4"-Titanium
- C)** 05-2127 Gaskin, Angled, 11mm, 3-3/8"-Titanium
- D)** 05-2123 Kelman/McPherson, Angled, 8mm, 3-3/8"-Titanium

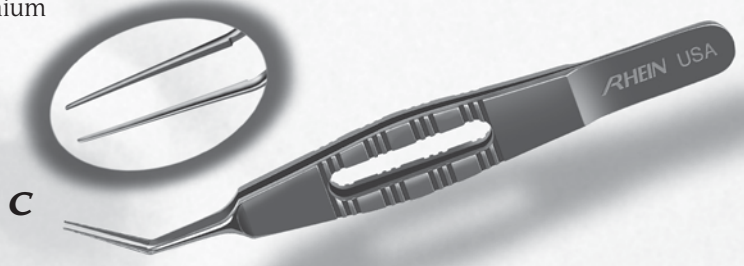

C

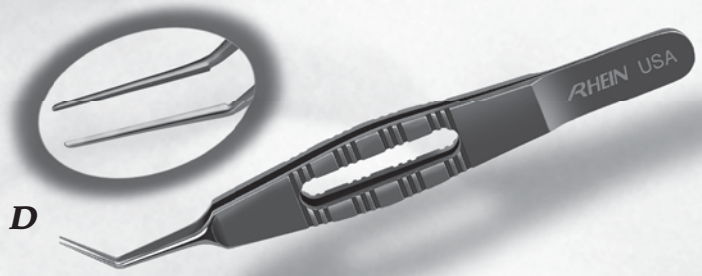

D

13.40



ELEVATING THE QUALITY OF CARE IN OPHTHALMOLOGY
 800-637-4346



1-800-263-3557

FORCEPS

Tying Forceps-Titanium

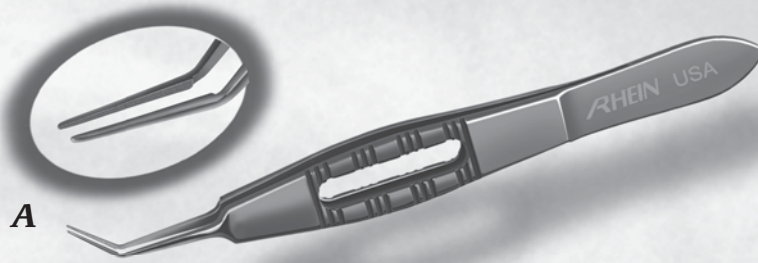

A

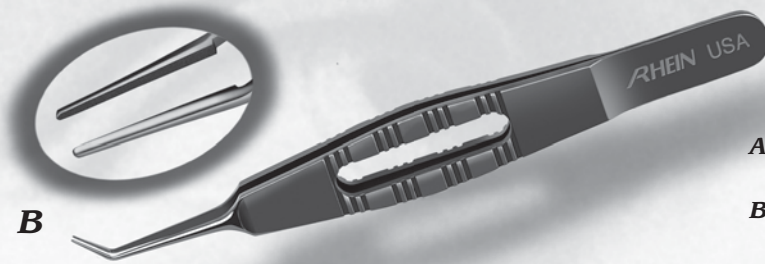

B

- A)** 05-2124 Kelman/McPherson, Angled, 8mm, 4"-Titanium
- B)** 05-2119 McPherson, Angled, 5mm, 3-3/8"-Titanium
- 05-2120 McPherson, Angled, 5mm, 4"-Titanium
- C)** 05-2134 Rhein/Maumenee Cross Action-Titanium
- D)** 05-2131 Round Handle w/Flat Ridge, Curved, 4"-Titanium

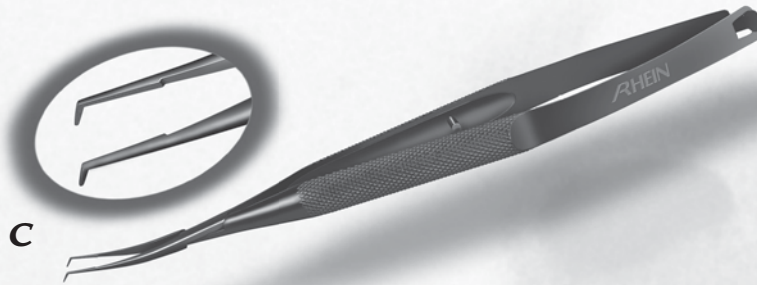

C



D

13.41



ELEVATING THE QUALITY



1-800-263-3557



FORCEPS

Tying Forceps-Titanium

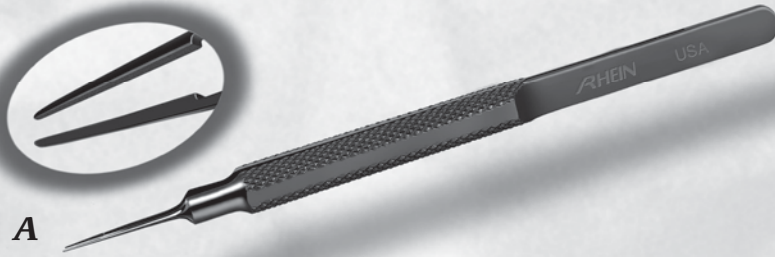

A

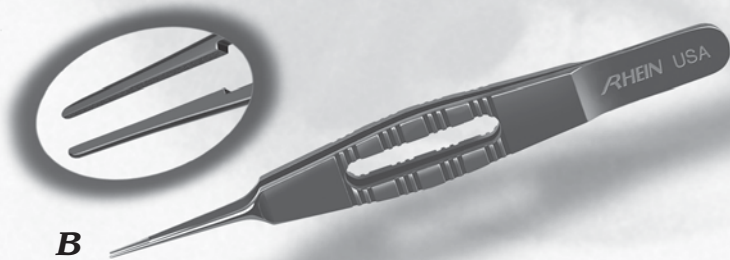

B

Tying Forceps-Titanium

- A) 05-2130 Round Handle w/Flat Ridge, Straight, 4"-Titanium
- B) 05-2111 Straight, 3-3/8"-Titanium
- C) 05-2115 Straight, 4"-Titanium

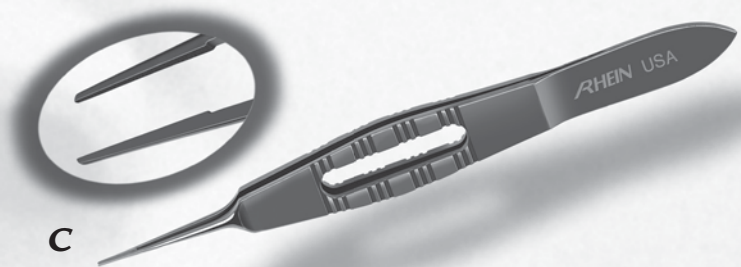

C

13.42



ELEVATING THE QUALITY OF CARE IN OPHTHALMOLOGY
800-637-4346





13.43



ELEVATING THE QUALITY

ACOR

1-800-263-3557



■ **GLOBE FIXATION INSTRUMENTS**

Global Fixation:

Our global fixation instruments have small pegs on the posterior segment, allowing firm fixation of the globe over the sclera, without tearing the conjunctiva. Generally, they are available on fixed or swivel handles.



LASIK Spatulas Are Designed To:

- 1) Reflect the flap during primary surgery;
- 2) Lift and reflect the flap during enhancement surgery;
- 3) Return the flap to the bed after ablation.

LASIK Fixation Rings Are Designed To:

Fixate the globe steady during hyperopic cases and protect the hinge and flap from the laser during laser ablation. Our LASIK markers are designed to be inked and placed on the cornea prior to using the microkeratome. These marks help the surgeon place the flap in the proper orientation on the bed.

14.00



ELEVATING THE QUALITY OF CARE IN OPHTHALMOLOGY
800-637-4346



GLOBE FIXATION INSTRUMENTS

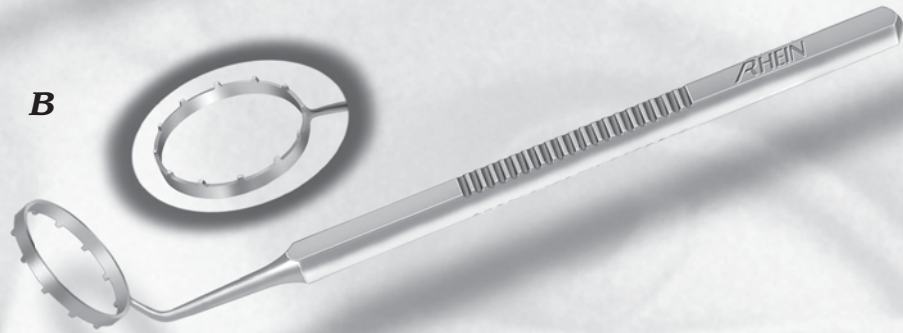

- A)** 8-15219 Thornton 16mm Diameter Ring w/Swivel Handle
- B)** 8-15220 Thornton 16mm Diameter Fixation Ring w/Fixed Handle
- C)** 8-15223 Fine/Thornton 16mm Ring w/Swivel Handle
- D)** 8-15217 Nichamin Fixation Ring w/10 Degree Marks 13mm ID

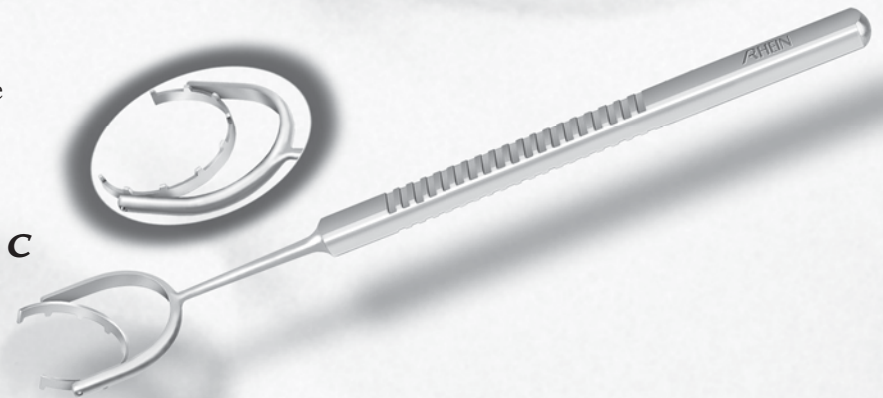

14.01



ELEVATING THE QUALITY



ACOR

1-800-263-3557



GLOBE FIXATION INSTRUMENTS

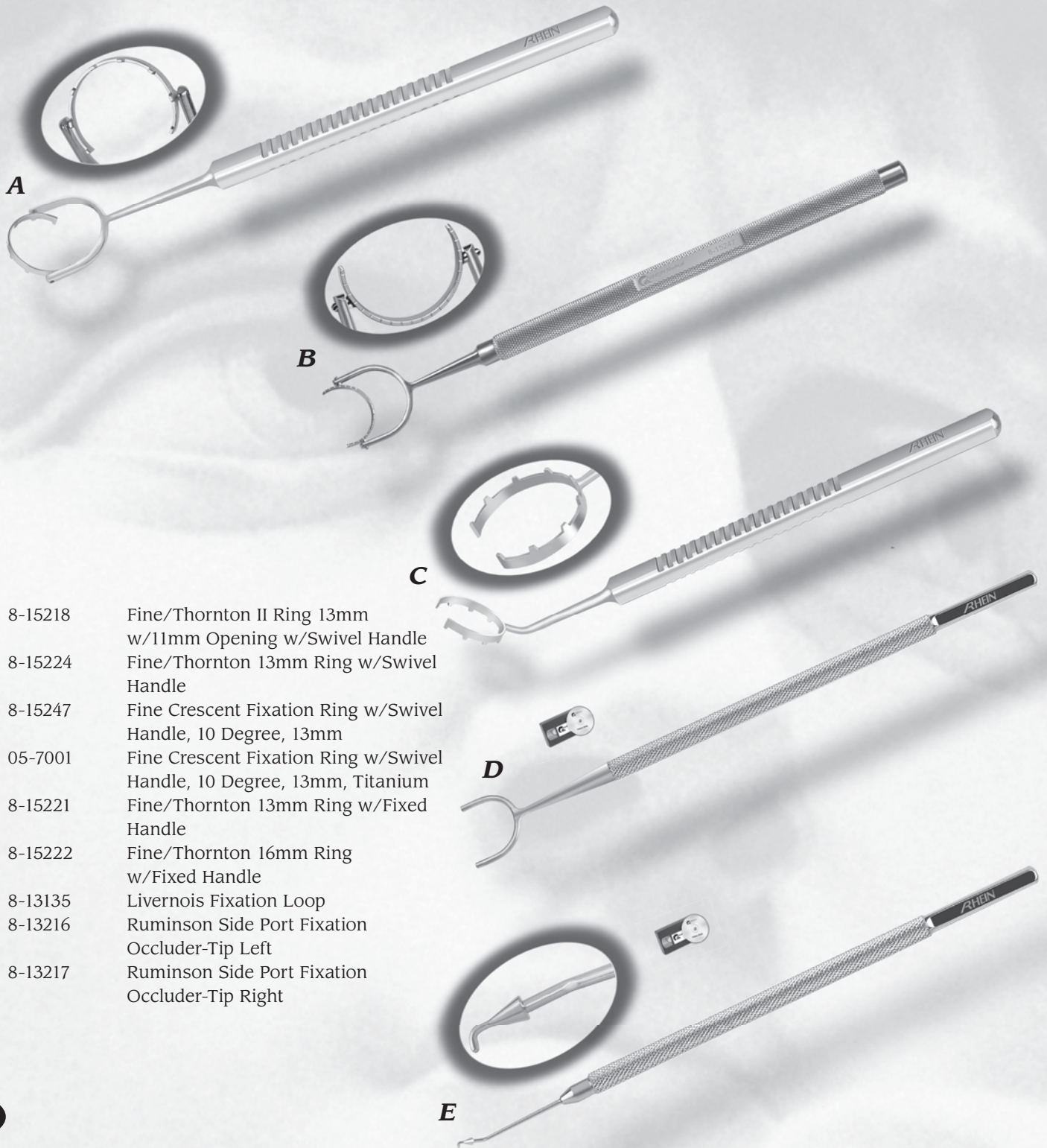

- A)** 8-15218 Fine/Thornton II Ring 13mm w/11mm Opening w/Swivel Handle
- 8-15224 Fine/Thornton 13mm Ring w/Swivel Handle
- B)** 8-15247 Fine Crescent Fixation Ring w/Swivel Handle, 10 Degree, 13mm
- 05-7001 Fine Crescent Fixation Ring w/Swivel Handle, 10 Degree, 13mm, Titanium
- C)** 8-15221 Fine/Thornton 13mm Ring w/Fixed Handle
- 8-15222 Fine/Thornton 16mm Ring w/Fixed Handle
- D)** 8-13135 Livernois Fixation Loop
- E)** 8-13216 Ruminson Side Port Fixation Occluder-Tip Left
- 8-13217 Ruminson Side Port Fixation Occluder-Tip Right

14.02



ELEVATING THE QUALITY OF CARE IN OPHTHALMOLOGY
800-637-4346



GLOBE FIXATION INSTRUMENTS

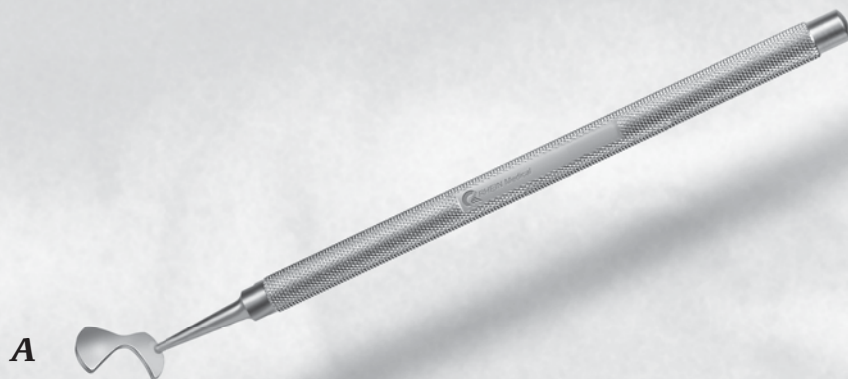

A

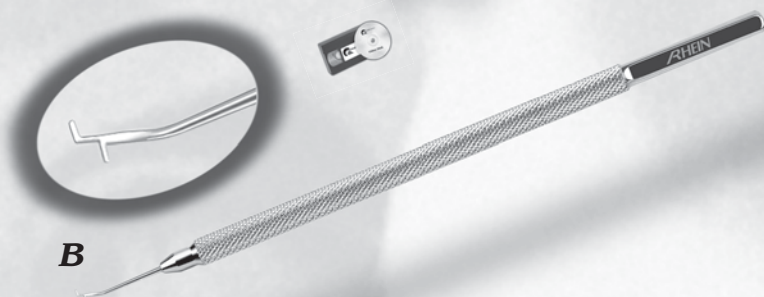

B

- A)** 8-13213 Stamler Corneal Transplant Stabilizer
- B)** 8-13212 Stamler Side Port Fixation Hook - Right Hand Dominant (Patent #6,299,617)
- 8-13212-L Stamler Side Port Fixation Hook - Left Hand Dominant (Patent #6,299,617)
- C)** 8-13127 Twist Fixation Hook, .3mm Left
- 8-13126 Twist Fixation Hook, .3mm Right
- 8-13128 Twist Fixation Hook, .5mm Right
- 8-13130 Twist Fixation Hook, .5mm Left
- D)** 8-15255 Rousseau Chin Lift Stabilizer



C



D

14.03



ELEVATING THE QUALITY

ACOR

1-800-263-3557

HOOKS, MANIPULATORS

15.00

- **Iris Hooks-15.01**
- **Lens Manipulators-15.02**
- **Nucleus Manipulators-15.07**
- **Tenotomy Hooks-15.11**
- **Curettes-15.11**

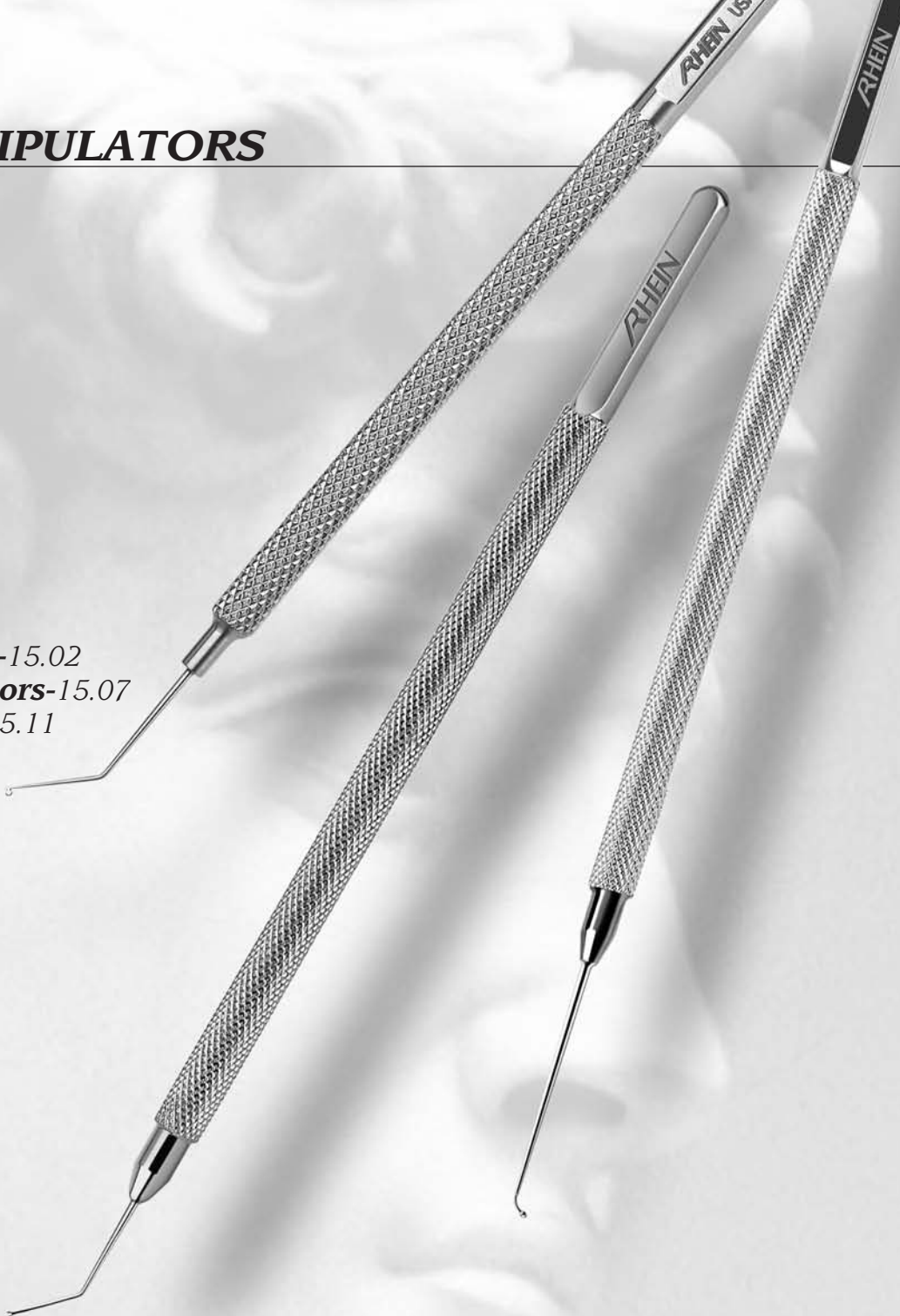

Hooks & Manipulators:
Some of our hooks and manipulators are offered in either stainless steel or titanium.



ELEVATING THE QUALITY OF CARE IN OPHTHALMOLOGY
800-637-4346



1-800-263-3557

HOOKS, MANIPULATORS

Iris Hooks

15.01

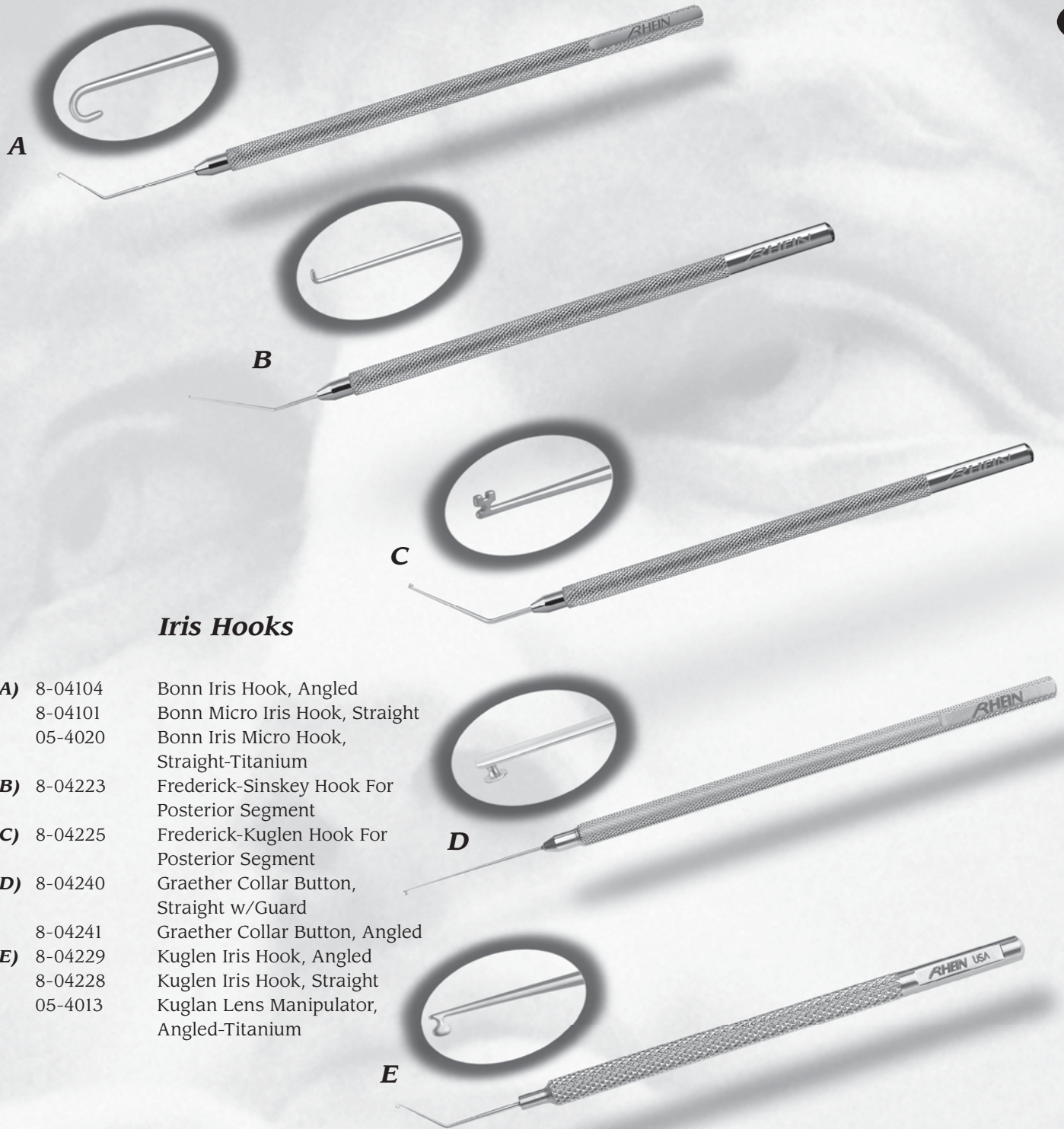

Iris Hooks

- A)** 8-04104 Bonn Iris Hook, Angled
8-04101 Bonn Micro Iris Hook, Straight
05-4020 Bonn Iris Micro Hook,
Straight-Titanium
- B)** 8-04223 Frederick-Sinskey Hook For
Posterior Segment
- C)** 8-04225 Frederick-Kuglen Hook For
Posterior Segment
- D)** 8-04240 Graether Collar Button,
Straight w/Guard
8-04241 Graether Collar Button, Angled
- E)** 8-04229 Kuglen Iris Hook, Angled
8-04228 Kuglen Iris Hook, Straight
05-4013 Kuglan Lens Manipulator,
Angled-Titanium



ELEVATING THE QUALITY



1-800-263-3557



HOOKS, MANIPULATORS

Iris Hooks

15.02

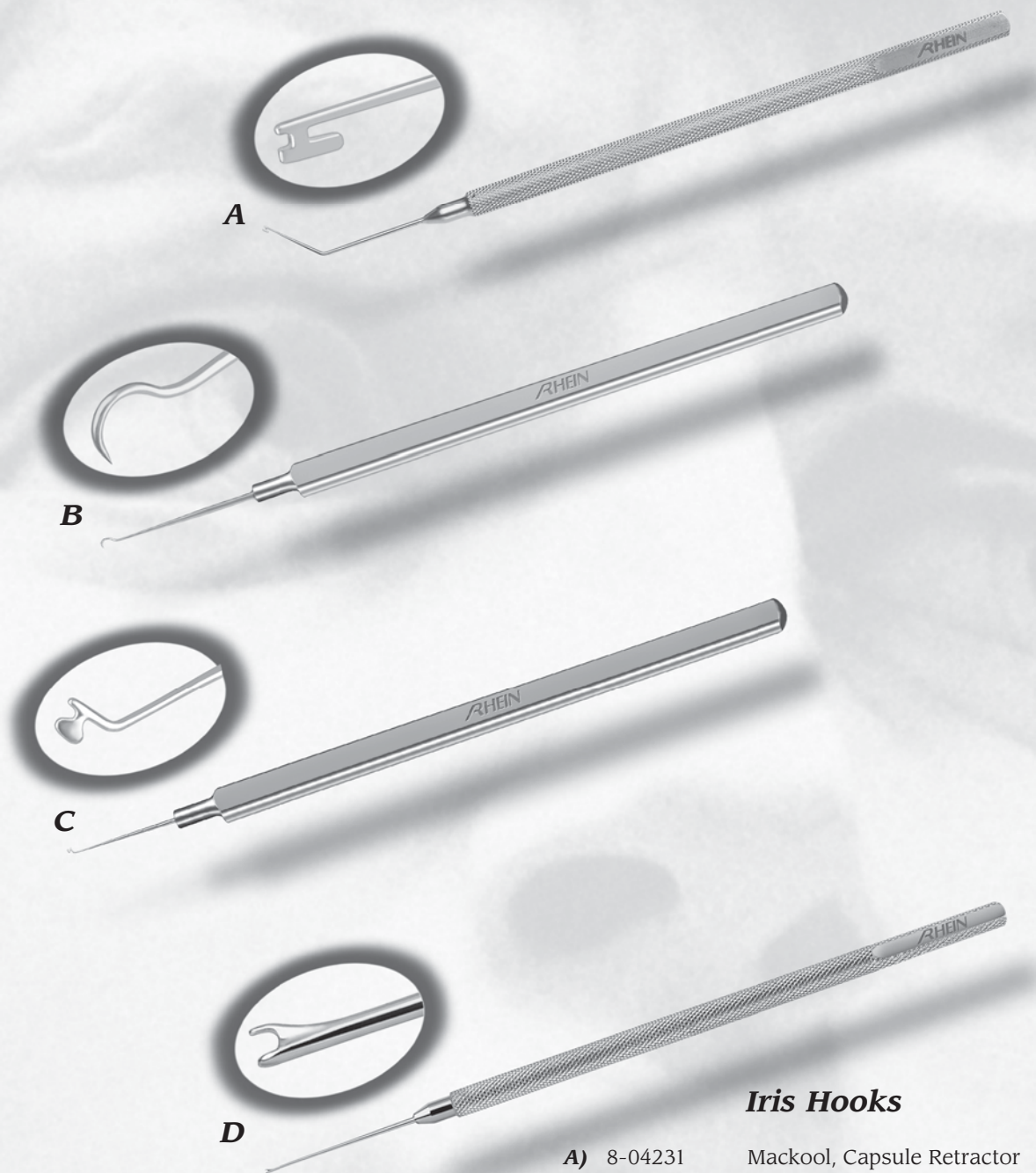

Iris Hooks

- A) 8-04231 Mackool, Capsule Retractor
- B) 8-04123 Tyrell Iris Hook 5" Sharp
- 8-04115 Tyrell Iris Hook 5" Blunt
- C) 8-04124 Wise Iris and Capsule Retractor

Lens Manipulators

- D) 8-04201 Aker Lens Pusher, Round Handle



ELEVATING THE QUALITY OF CARE IN OPHTHALMOLOGY
800-637-4346



1-800-263-3557

HOOKS, MANIPULATORS

Lens Manipulators

15.03

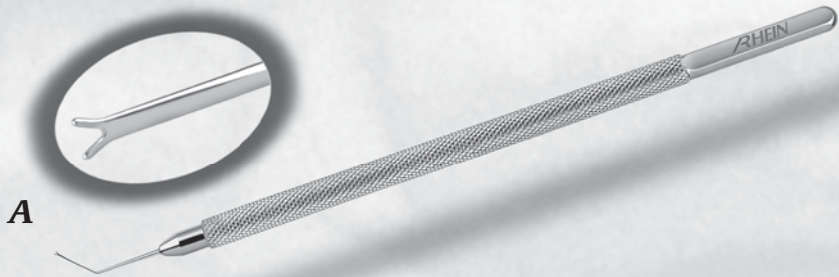

A

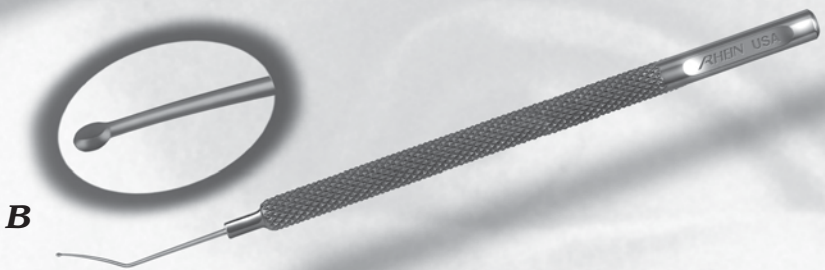

B

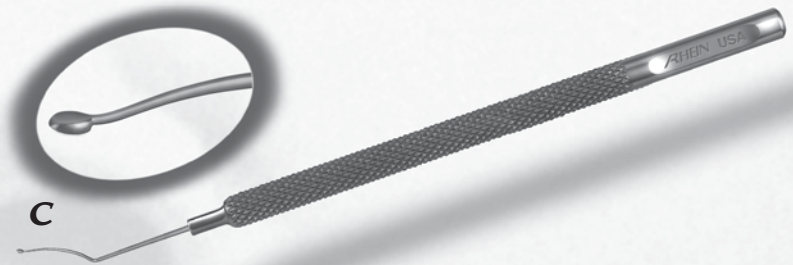

C

Lens Manipulators

- A)** 8-04207 Bechert Lens Pusher 45, Angled
- B)** 05-4060 Battle ICL Manipulator-Titanium
- C)** 05-4059 Chu ICL Manipulator-Titanium
- D)** 8-04312 Clayman Lens Rotator, .5mm Wide, V/Notch

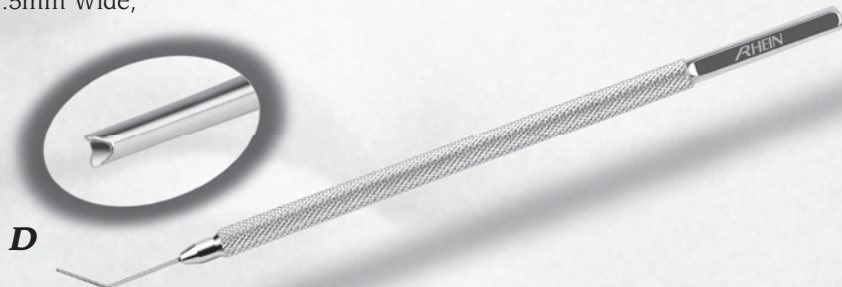

D



ELEVATING THE QUALITY



1-800-263-3557

HOOKS, MANIPULATORS

Lens Manipulators

15.04

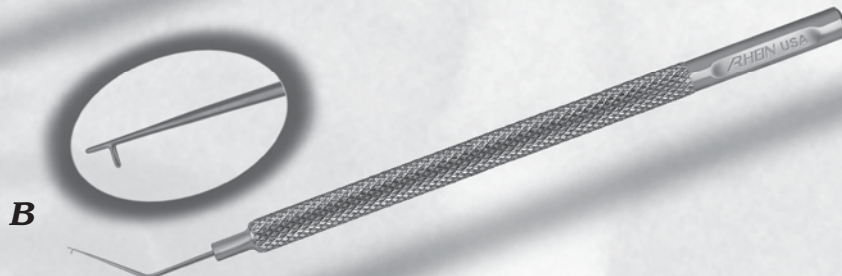
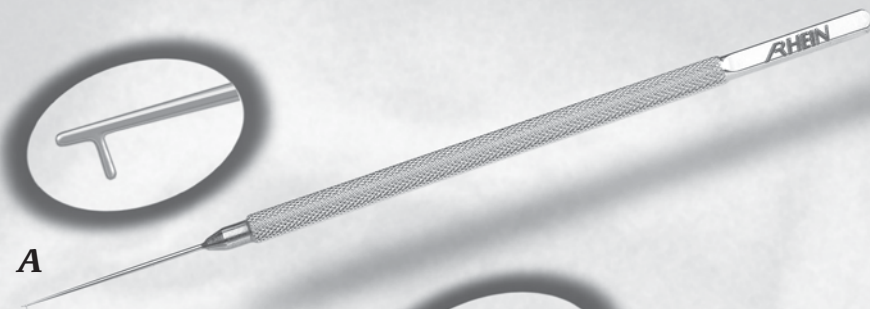

Lens Manipulators

- A)** 8-04233 Fenzl Lens Hook, .15mm, Straight w/Guard
- 8-04234 Fenzl Lens Hook, .15mm, Angled
- B)** 05-4026 Fenzl Lens Manipulator, Angled-Titanium
- 05-4025 Fenzl Lens Manipulator, Straight, Titanium
- C)** 8-04210 Jaffe Lens Manipulator, Straight, .15mm Diameter
- D)** 8-04236 Jaffe/Maltzman Lens Manipulator, .15 Diameter, V-Shaped
- E)** 8-04203 Lester Lens Pusher, Angled, Round Handle
- 8-04202 Lester Lens Pusher, Straight w/Guard, Round Handle
- 05-4018 Lester Lens Manipulator, Angled-Titanium
- 05-4017 Lester Lens Manipulator, Straight-Titanium

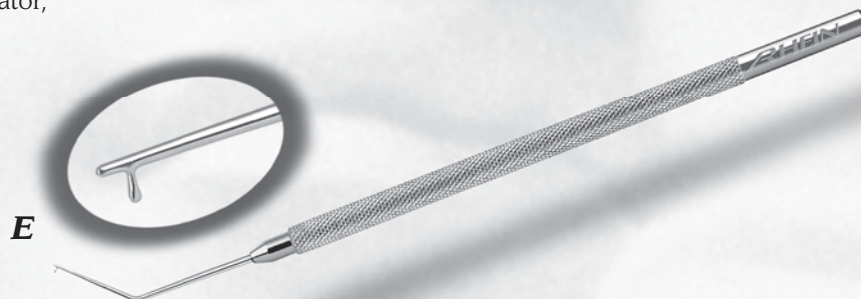

ELEVATING THE QUALITY OF CARE IN OPHTHALMOLOGY
800-637-4346



1-800-263-3557

HOOKS, MANIPULATORS

Lens Manipulators

15.05

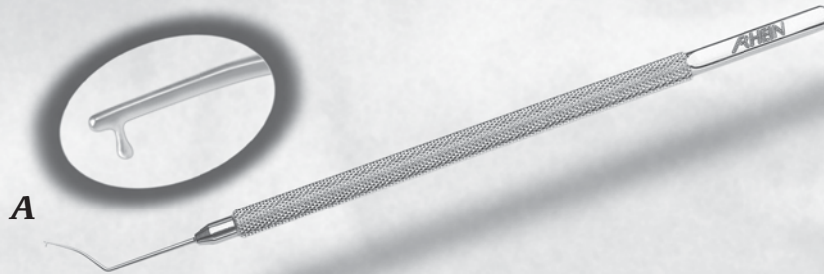

A

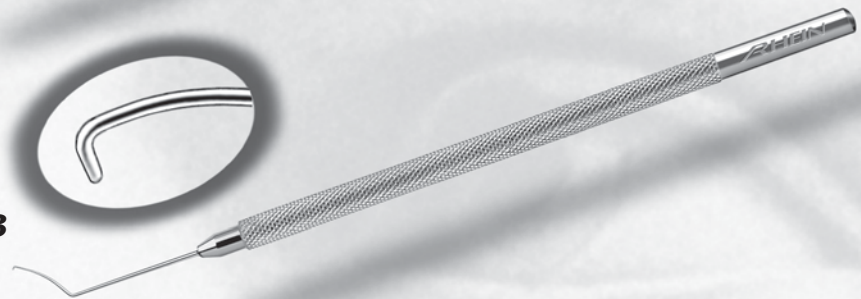

B

Lens Manipulators

- A)** 8-04205 Lester Modified Hook, Angled, Round Handle
- B)** 8-04224 Lewicky Lens Manipulator, Angled, .15mm Diameter
- C)** 8-04235 Maltzman/Fenzl Hook, .15mm Straight w/Guar
- D)** 8-04230 Osher "Y" Hook, Straight
- E)** 8-07149 Khouri Phaco Nucleus Manipulator

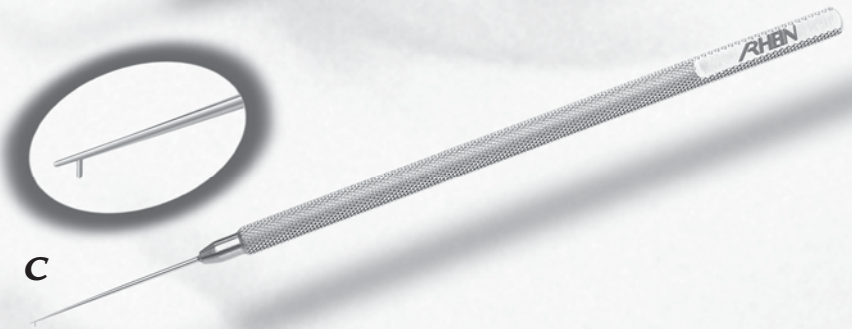

C

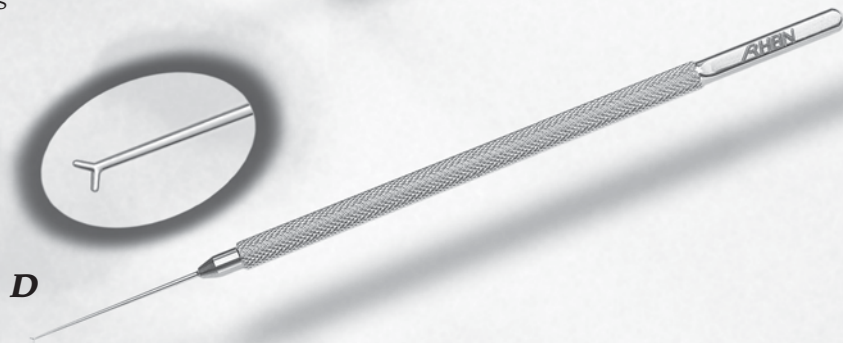

D



E

RHEIN Medical

ELEVATING THE QUALITY



1-800-263-3557

HOOKS, MANIPULATORS

Lens Manipulators

15.06

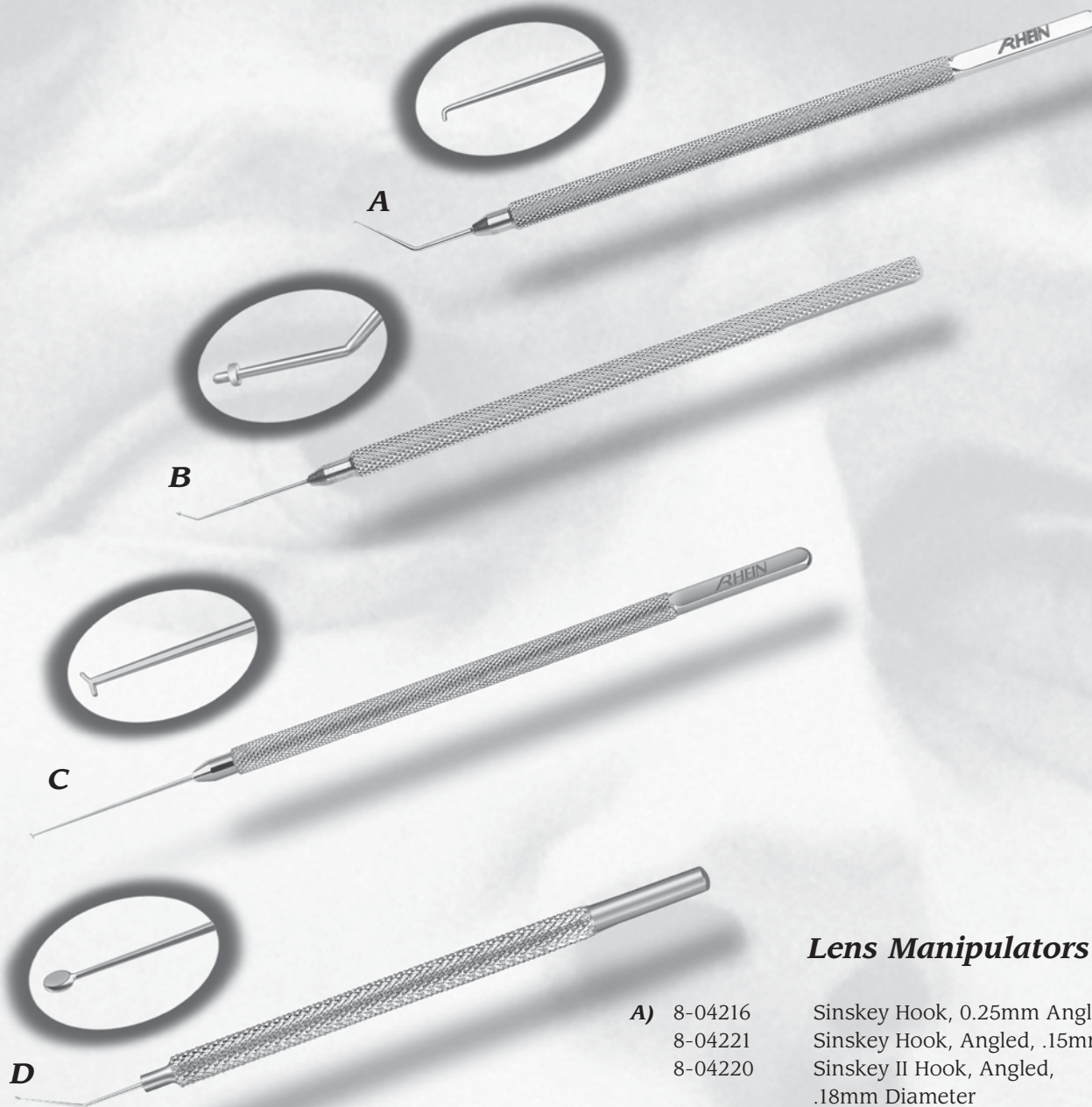

Lens Manipulators

- A) 8-04216 Sinskey Hook, 0.25mm Angled Round
- 8-04221 Sinskey Hook, Angled, .15mm Tip
- 8-04220 Sinskey II Hook, Angled, .18mm Diameter
- 8-04219 Sinskey II Hook, Straight w/Guard, .18mm Diameter
- 05-4011 Sinskey Hook, Straight-Titanium
- 05-4012 Sinskey Hook, Angled-Titanium
- B) 8-04227 Tennant Lens Probe, .4mm Diameter Tip, w/Collar
- C) 8-07148 Ursell IOL Manipulator
- D) 8-07150 Vukich ICL Manipulator



ELEVATING THE QUALITY OF CARE IN OPHTHALMOLOGY
800-637-4346



1-800-263-3557

HOOKS, MANIPULATORS

Nucleus Manipulators

15.07

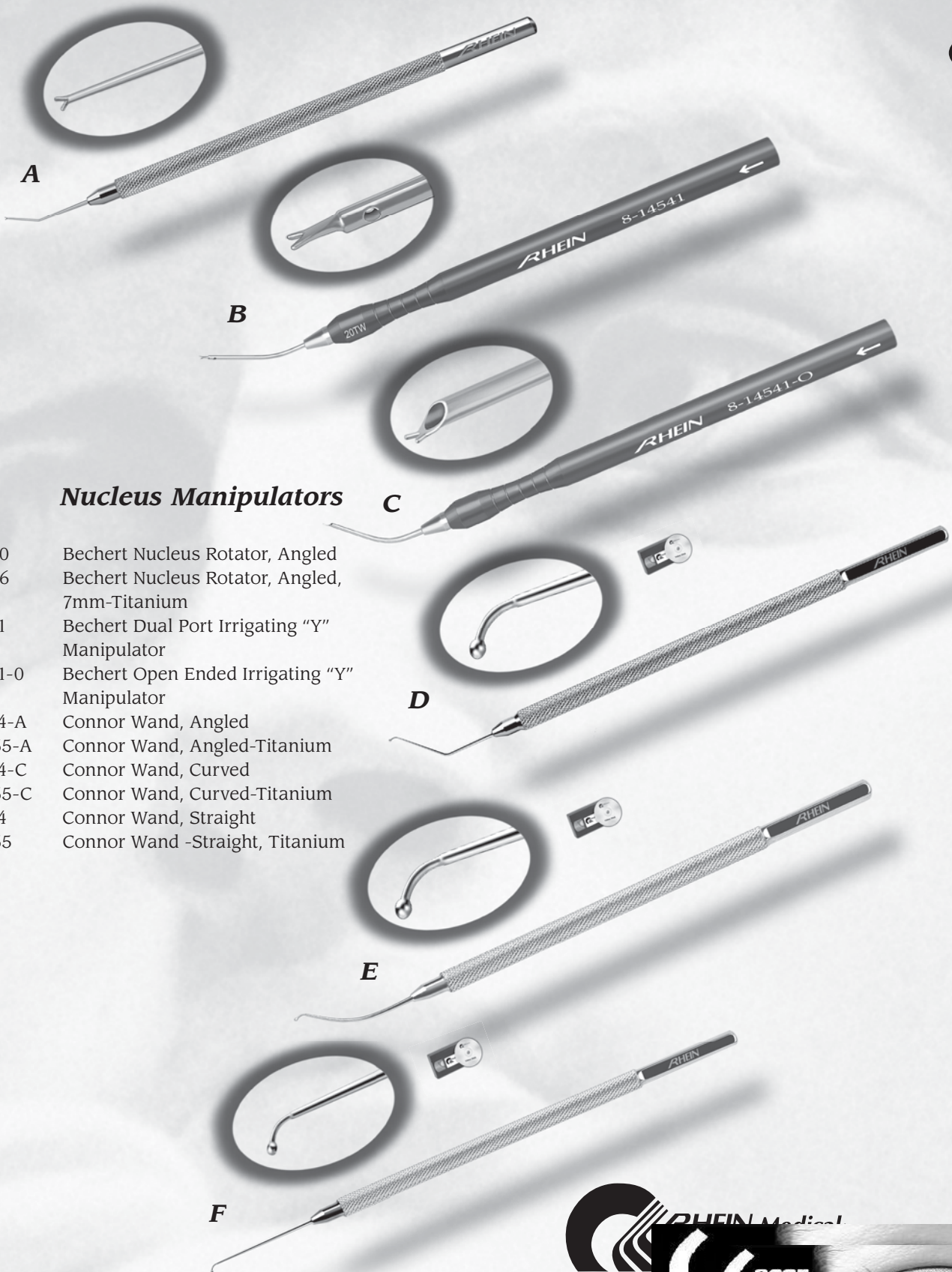

Nucleus Manipulators

- A)** 8-04310 Bechert Nucleus Rotator, Angled
05-4016 Bechert Nucleus Rotator, Angled, 7mm-Titanium
- B)** 8-14541 Bechert Dual Port Irrigating "Y" Manipulator
- C)** 8-14541-0 Bechert Open Ended Irrigating "Y" Manipulator
- D)** 8-07114-A Connor Wand, Angled
05-4055-A Connor Wand, Angled-Titanium
- E)** 8-07114-C Connor Wand, Curved
05-4055-C Connor Wand, Curved-Titanium
- F)** 8-07114 Connor Wand, Straight
05-4055 Connor Wand -Straight, Titanium



ELEVATING THE QUALITY



1-800-263-3557

HOOKS, MANIPULATORS

Nucleus Manipulators

15.08

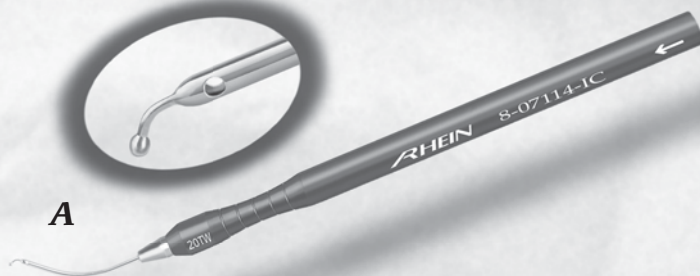

A



B



C

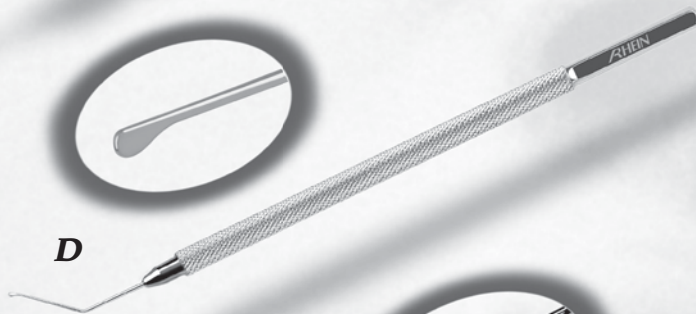

D



E

Nucleus Manipulators

- A) 8-07114-IC Connor Wand, Curved w/Right & Left 20g Irrigation Ports, Aluminum Handle
- 8-07114-IS Connor Wand, Straight w/Right & Left 20g Irrigation Ports, Aluminum Handle
- B) 8-07114-I Connor Wand, Straight w/Distal Irrigation
- C) 8-07114-ISO Connor Wand, Straight w/Open-Ended Irrigation, Aluminum Handle
- 8-07114-ICO Connor Wand, Curved w/Open-Ended Irrigation, Aluminum Handle
- D) 8-07117 Drysdale Nucleus Manipulator
- E) 8-07111 Goldberg Side Port Nucleus Splitter
- 05-4050 Goldberg Side Port Nucleus Splitter-Titanium



ELEVATING THE QUALITY OF CARE IN OPHTHALMOLOGY
800-637-4346



1-800-263-3557

HOOKS, MANIPULATORS

Nucleus Manipulators

15.09

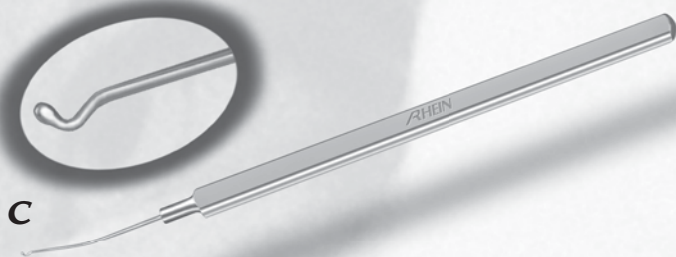
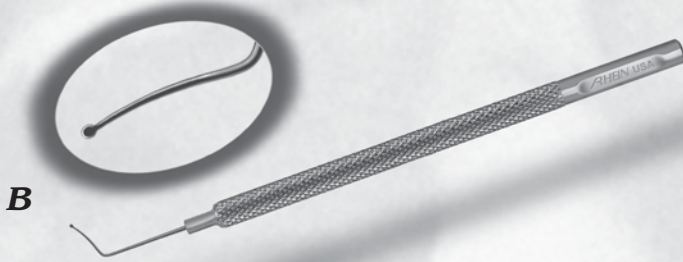
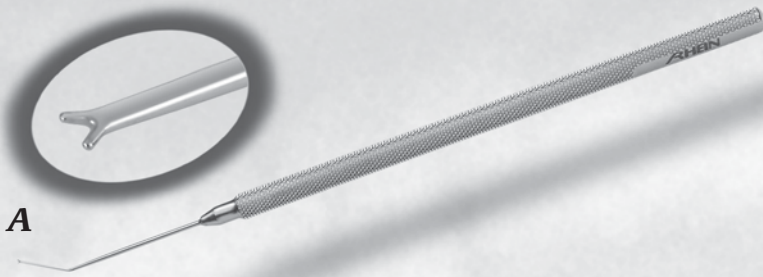

- A)** 8-04311 Jaffe/Bechert Nucleus Rotator, Angled
B) 05-4061 Jarrett Side Port Nucleus Manipulator, Titanium
C) 8-07149 Khouri Phaco Nucleus Manipulator
D) 8-07108 Koch Nucleus Manipulator
05-4062 Koch Nucleus Manipulator-Titanium
E) 05-4030 Lindstrom Star Nucleus Manipulator, Angled-Titanium
F) 8-07116 Newsom Side Port Nucleus Cracker
05-4063 Newsom Side Port Nucleus Cracker-Titanium

Nucleus Manipulators



ELEVATING THE QUALITY



1-800-263-3557



HOOKS, MANIPULATORS

Nucleus Manipulators

15.10

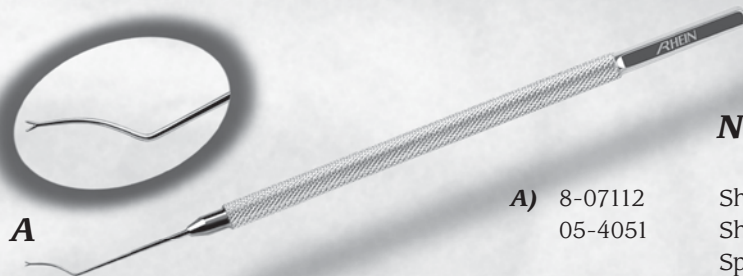

A

A) 8-07112
05-4051

Nucleus Manipulators

Sharvelle Side Port Nucleus Splitter
Sharvelle Side Port Nucleus
Splitter-Titanium

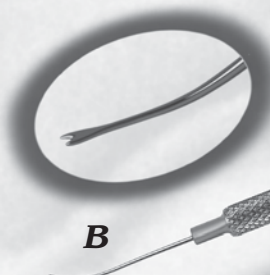

B

B) 05-4032

Steinert-Koch Nucleus Manipulator,
Curved-Titanium

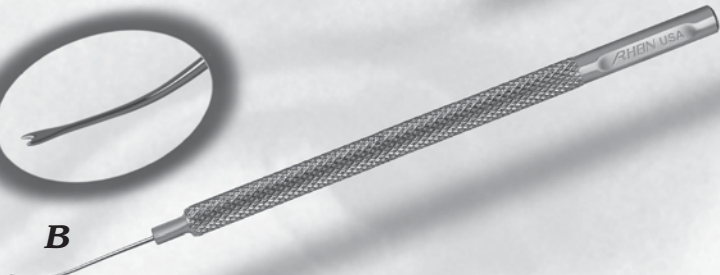

C) 8-07113
05-4052

Wan Side Port Nucleus Splitter
Wan Side Port Nucleus Splitter-
Titanium

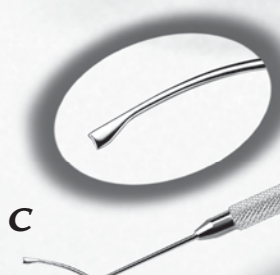

C

D) 8-04306

Lewis Lens Loop 5-1/4", Smooth
Loop 5.5x8mm

8-04305

Lewis Lens Loop 5-1/4", Serrated
Loop 5.5x8mm

E) 8-04307

New Orleans Lens Loop
5-1/4", Smooth Loop

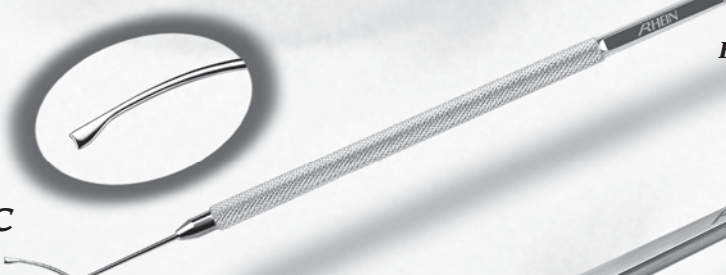

F) 8-04308

Wilder Lens Loop 5-1/4", Serrated
Loop 4x15mm

8-04309

Wilder Lens Loop 5-1/4", Smooth
Loop 4x15mm

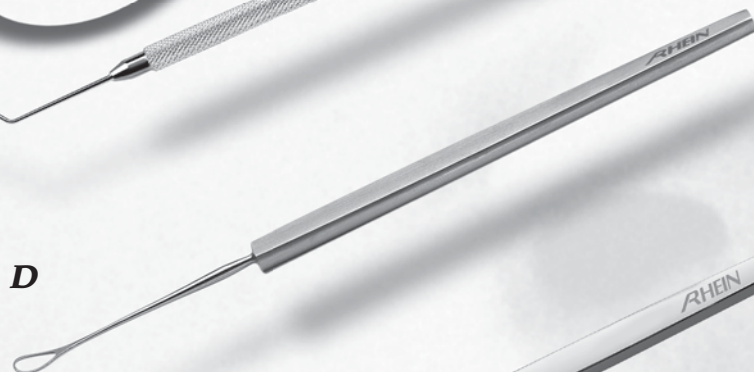

D

E

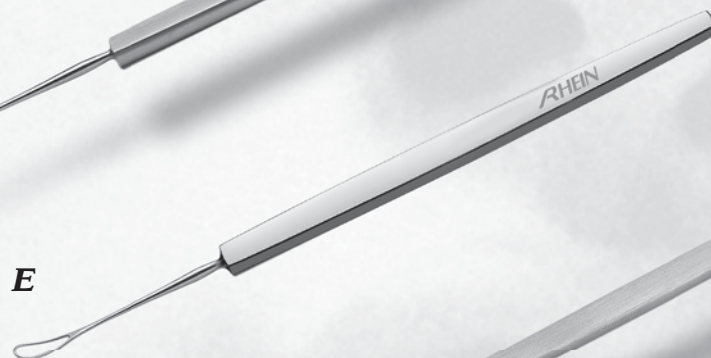

F



ELEVATING THE QUALITY OF CARE IN OPHTHALMOLOGY
800-637-4346



1-800-263-3557

HOOKS, MANIPULATORS

Tenotomy Hooks

15.11

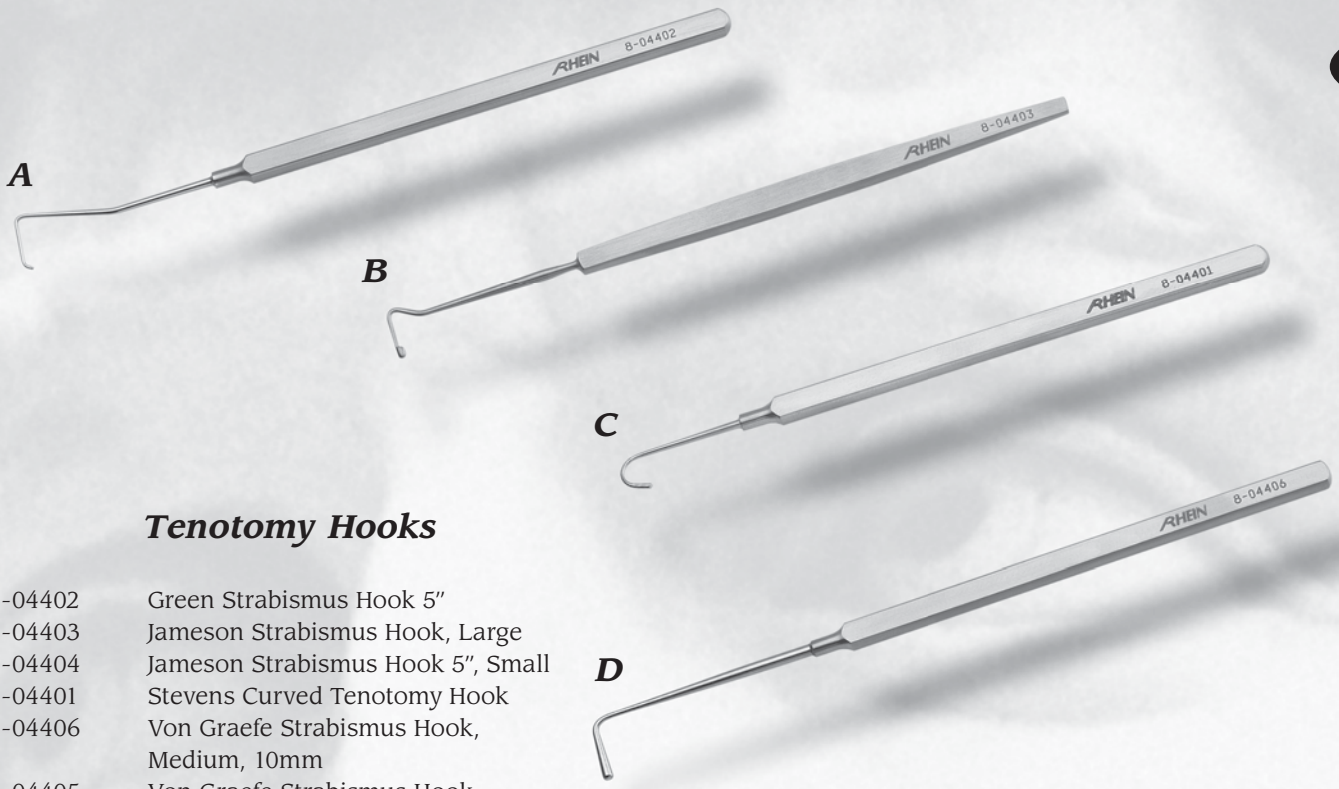

Tenotomy Hooks

- A)** 8-04402 Green Strabismus Hook 5"
- B)** 8-04403 Jameson Strabismus Hook, Large
8-04404 Jameson Strabismus Hook 5", Small
- C)** 8-04401 Stevens Curved Tenotomy Hook
- D)** 8-04406 Von Graefe Strabismus Hook, Medium, 10mm
8-04405 Von Graefe Strabismus Hook, Small, 8mm
8-04407 Von Graefe Strabismus Hook, Large, 11mm

Curettes

- E)** 8-06101 Meyerhoefer Curette Size 00, 1.0mm
- 8-06102 Meyerhoefer Curette Size 0, 1.5mm
- 8-06103 Meyerhoefer Curette Size 1, 1.7mm
- 8-06104 Meyerhoefer Curette Size 2, 2.0mm
- 8-06105 Meyerhoefer Curette Size 3, 2.5mm
- 8-06106 Meyerhoefer Curette Size 4, 3.5mm



ELEVATING THE QUALITY



1-800-263-3557

I/A & BI-MANUAL HANDPIECES & I/A TIPS

16.00



I&A Tips:

Custom Aspiration Port sizes are available upon request. The standard Aspiration Port size is .3mm. Contact us for more information.



ELEVATING THE QUALITY OF CARE IN OPHTHALMOLOGY
800-637-4346



1-800-263-3557

I/A & BI-MANUAL HANDPIECES & I/A TIPS

16.01



- A)** 8-14540 20g 0.3mm Cortex Extractor w/Capsule Polisher, Curved On Handpiece
- B)** 8-14550 Curved 20g Aspiration w/ Handpiece w/ Capsule Polisher, 0.3mm Port
- C)** 8-14551 Curved 20g Aspiration w/Handpiece w/ Capsule Polisher, 0.2mm Port
- D)** 8-14544 Curved 20g Dual Port Irrigation w/ Handpiece, 1.4mm Incision
- E)** 8-14545 Straight 20g Dual Port Irrigation w/ Handpiece, 1.4mm Incision
- F)** 8-14552 Bohigian 19g Anterior Chamber Maintainer w/Handpiece



ELEVATING THE QUALITY



1-800-263-3557



I/A & BI-MANUAL HANDPIECES & I/A TIPS

16.02

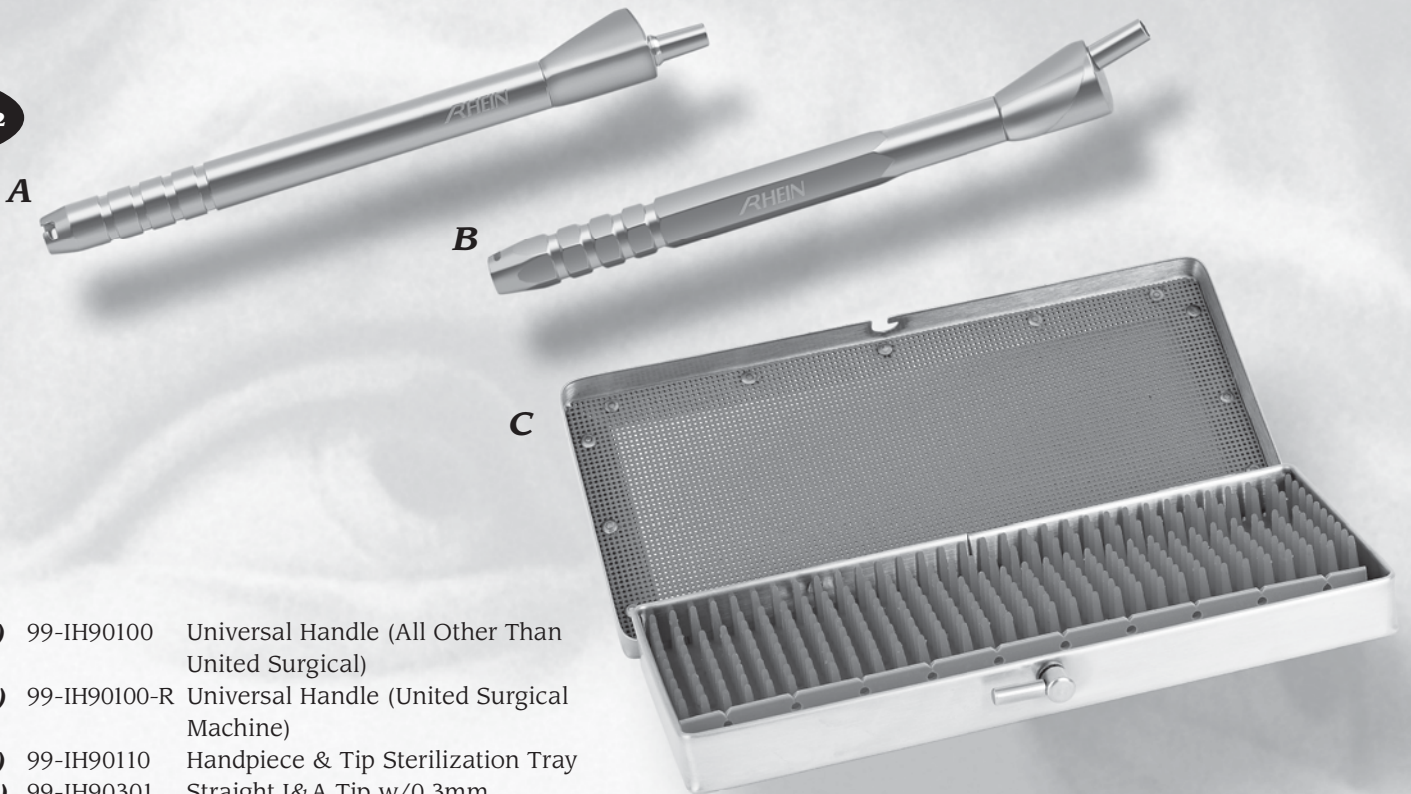

- A)** 99-IH90100 Universal Handle (All Other Than United Surgical)
- B)** 99-IH90100-R Universal Handle (United Surgical Machine)
- C)** 99-IH90110 Handpiece & Tip Sterilization Tray
- D)** 99-IH90301 Straight I&A Tip w/0.3mm Aspiration Port
- 99-IH90301.2 Straight I/A Tip w/0.2mm Aspiration Port
- 99-IH90301.5 Straight I/A Tip w/0.5mm Aspiration Port
- E)** 99-IH90302 Curved I&A Tip w/0.3mm Aspiration Port
- 99-IH90302.4 Curved I/A Tip w/0.4mm Aspiration Port
- 99-IH90302.5 Curved I/A Tip w/0.5mm Aspiration Port

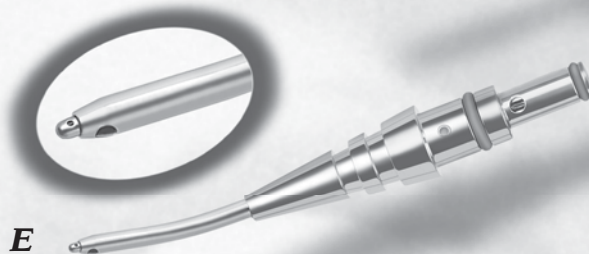
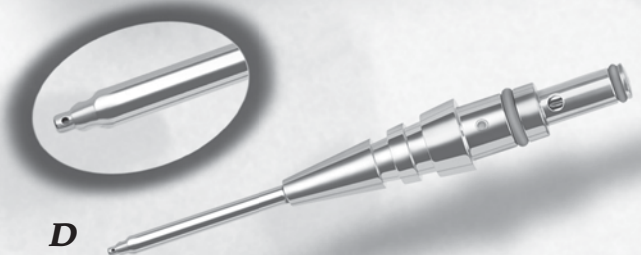

ELEVATING THE QUALITY OF CARE IN OPHTHALMOLOGY
800-637-4346



1-800-263-3557

I/A & BI-MANUAL HANDPIECES & I/A TIPS

16.03

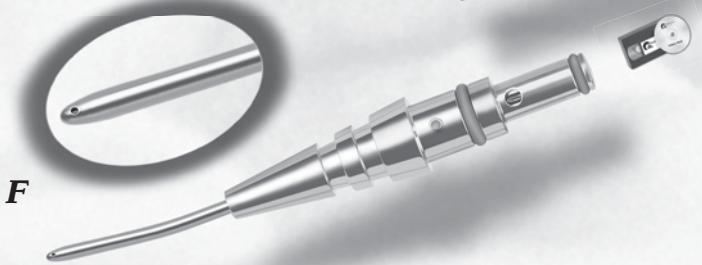
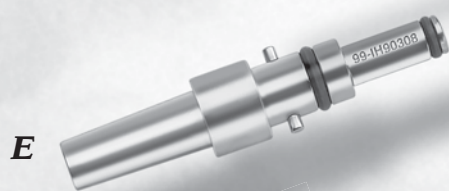
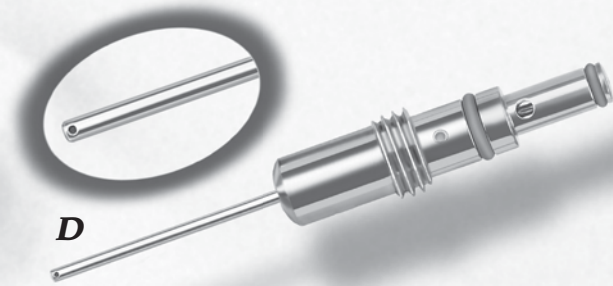
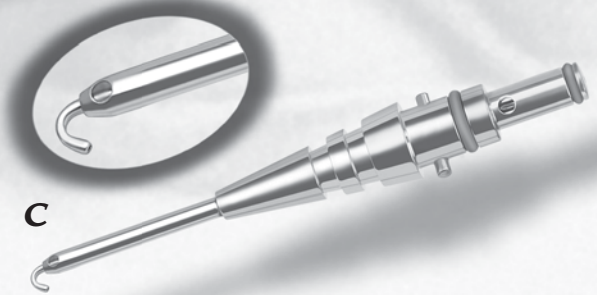
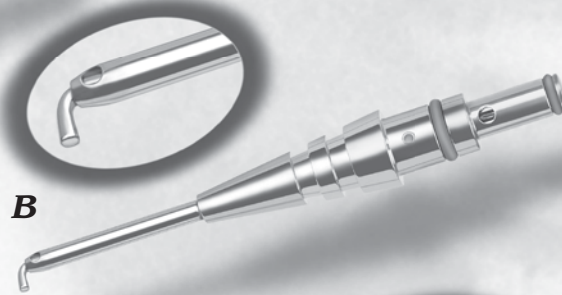
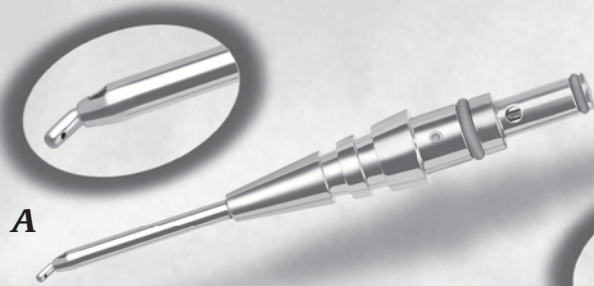

- A)** 99-IH90303 45 Degree Angled I&A Tip w/0.3mm Port
- 99-IH90303.5 45 Degree Angled I/A Tip w/0.5mm Aspir. Port
- B)** 99-IH90304 90 Degree Angled I&A Tip w/0.3mm Port
- 99-IH90304.5 90 Degree Angled I/A Tip w/0.5mm Aspir. Port
- C)** 99-IH90306 Binkhorst 180 Degree I&A Tip w/0.3mm Port
- 99-IH90306.4 Binkhorst 180 Degree I/A Tip w/0.4mm Port
- 99-IH90306.5 Binkhorst 180 Degree I/A Tip w/0.5mm Port
- D)** 99-IH90307 Straight Silicone Sleeve I&A Tip w/0.3mm Port
- E)** 99-IH90308 Luer Adaptor Tip For Cannulas
- F)** 99-IH90309 Kershner Clear Corneal I&A Tip w/0.3mm Asp.



ELEVATING THE QUALITY



1-800-263-3557



I/A & BI-MANUAL HANDPIECES & I/A TIPS

16.04

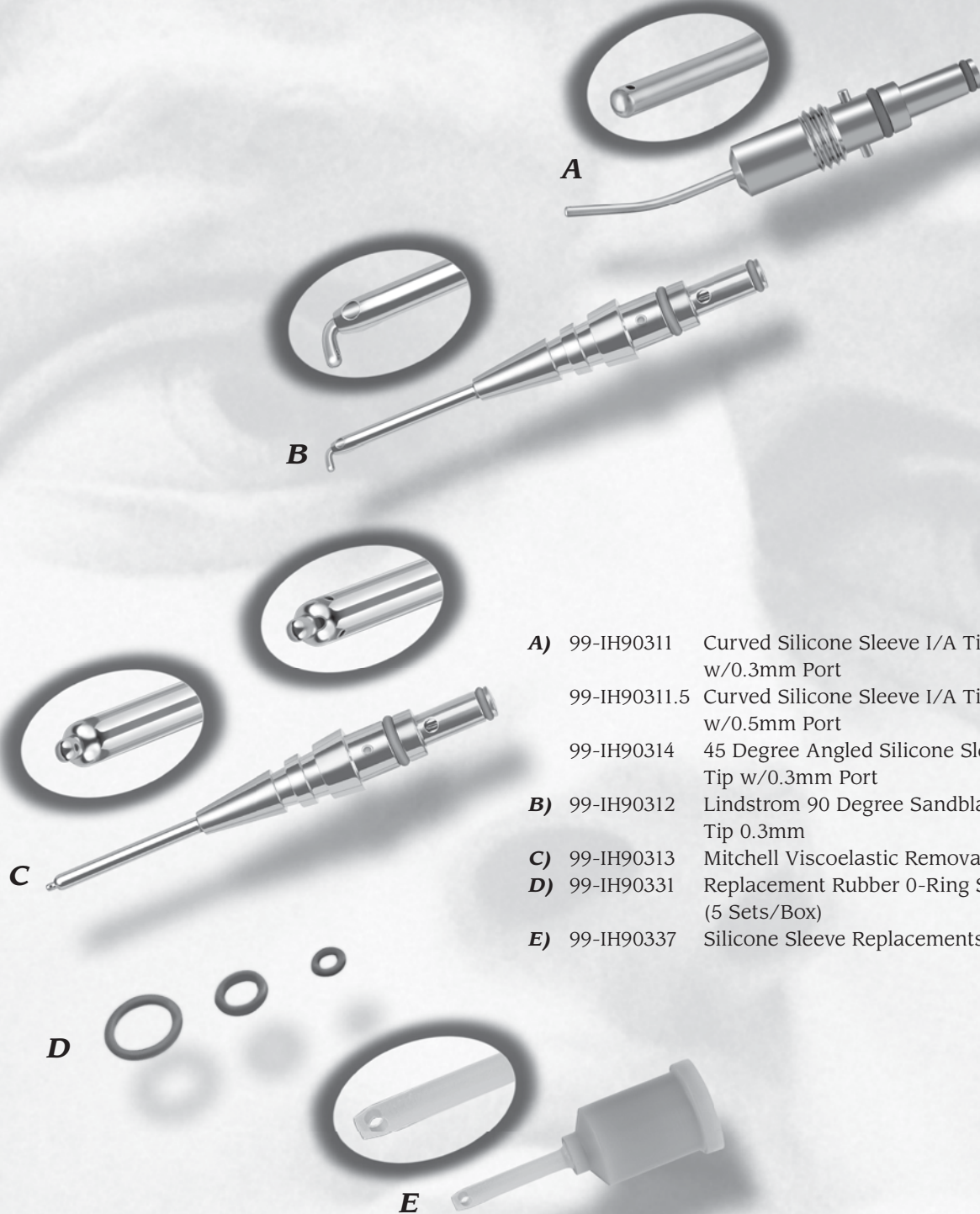

- A) 99-IH90311 Curved Silicone Sleeve I/A Tip w/0.3mm Port
- 99-IH90311.5 Curved Silicone Sleeve I/A Tip w/0.5mm Port
- 99-IH90314 45 Degree Angled Silicone Sleeve I/A Tip w/0.3mm Port
- B) 99-IH90312 Lindstrom 90 Degree Sandblasted I&A Tip 0.3mm
- C) 99-IH90313 Mitchell Viscoelastic Removal I/A Tip
- D) 99-IH90331 Replacement Rubber O-Ring Set (5 Sets/Box)
- E) 99-IH90337 Silicone Sleeve Replacements



ELEVATING THE QUALITY OF CARE IN OPHTHALMOLOGY
800-637-4346



I/A & BI-MANUAL HANDPIECES & I/A TIPS

16.05



A

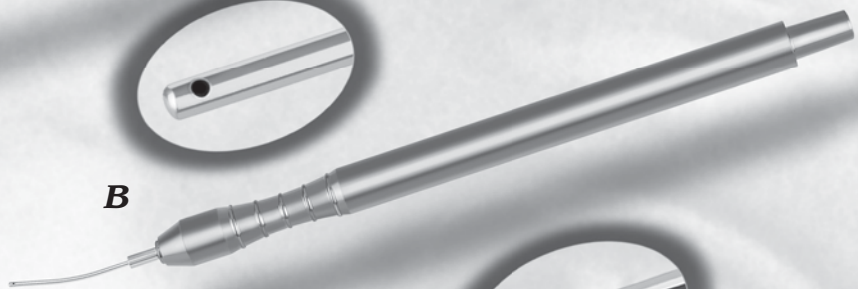

B

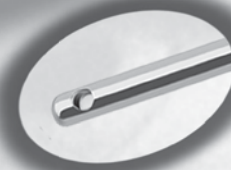

C

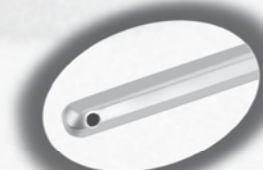

D

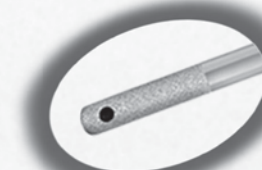

E

- A)** 99-IH90400 Straight Bi-Manual Irrigation Handpiece, .4mm, 23g
- B)** 99-IH90401 Curved Bi-Manual Aspiration Handpiece, .3mm, 23g
- C)** 99-IH90402 Straight Bi-Manual Irrigation Handpiece, .5mm, 21g
- D)** 99-IH90403 Curved Bi-Manual Aspiration Handpiece, .3mm, 21g
- E)** 99-IH90404 Curved Bi-Manual Aspiration Handpiece, .3mm, 23g, w/Polisher
- F)** 99-IH90405 Fine 21g Bi-Manual Irrigation Handpiece, Curved, 30 Degree Beveled Tip
- G)** 99-IH90406 Curved Bi-Manual Irrigation Handpiece, 5mm, 21g

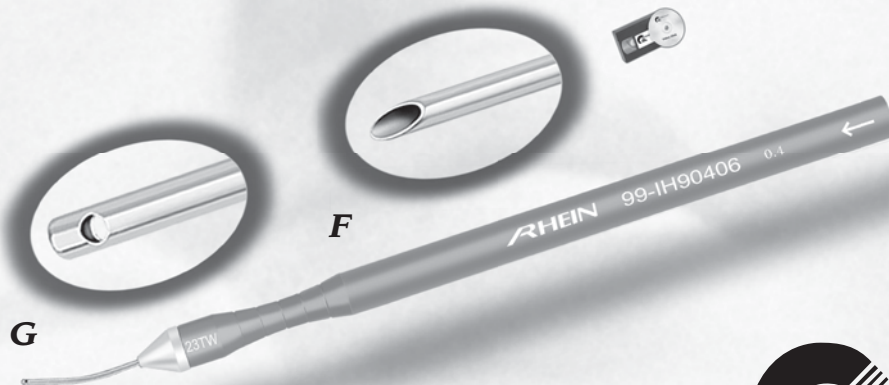

G

F



ELEVATING THE QUALITY



ACOR

1-800-263-3557



INTACS INSTRUMENTS

17.00



ELEVATING THE QUALITY OF CARE IN OPHTHALMOLOGY
800-637-4346



1-800-263-3557



A

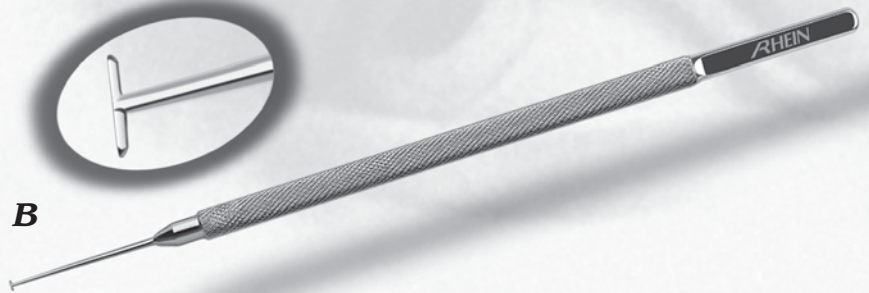

B

- A)** 05-9010 Brown INTACS Insertion Forceps-Titanium
- B)** 8-17100 Brown INTACS Pocket Starter



ELEVATING THE QUALITY



1-800-263-3557



LASEK INSTRUMENTS

18.00



ELEVATING THE QUALITY OF CARE IN OPHTHALMOLOGY
800-637-4346



1-800-263-3557

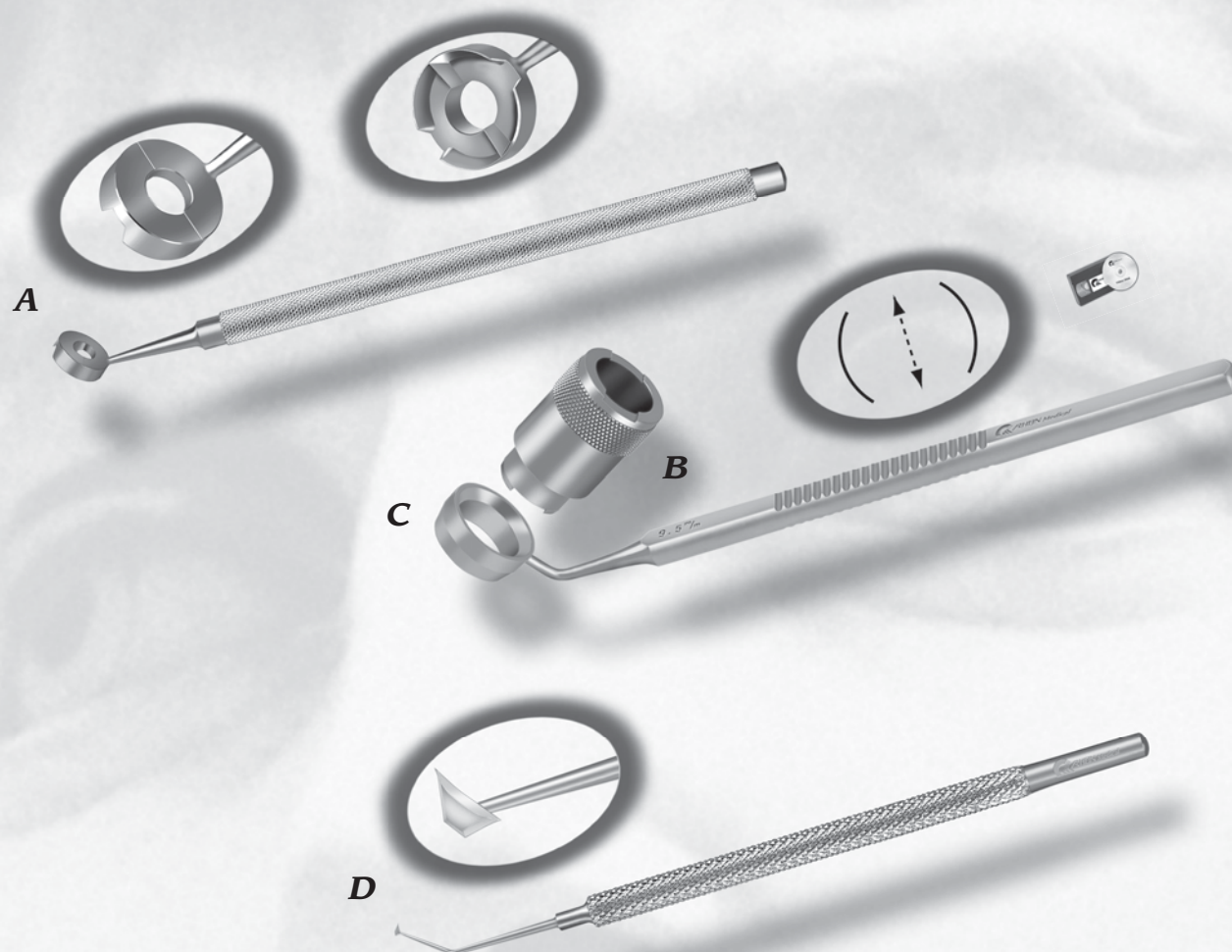

18.01

- A)** 8-17021 Brown LASEK Butterfly Trephine, 9.5mm
- B)** 8-17022 Brown LASEK Nested Trephine, 9mm w/.076mm Extension
- C)** 8-17023 Brown LASEK Nested Trephine Well, 9.5mm
- D)** 8-17024 Brown LASEK Micro Plow



LASEK INSTRUMENTS

18.02

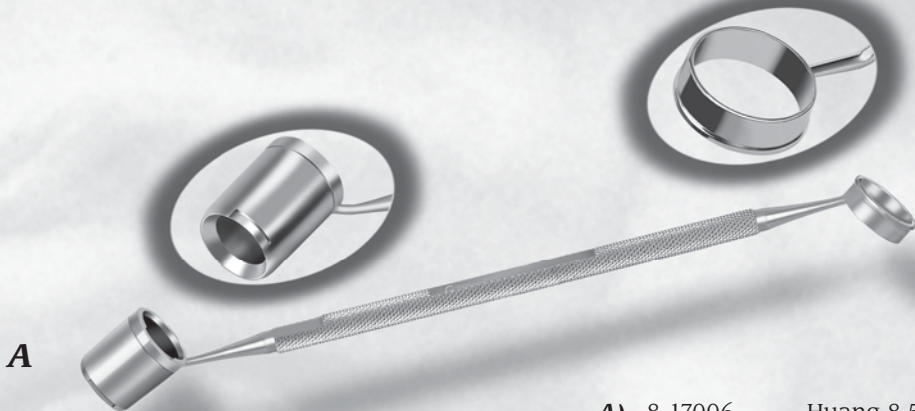

A

- A)** 8-17006 Huang 8.5mm LASEK Trephine w/.083mm Extension & 9mm Well
- 8-17005 Huang 7.5mm LASEK Trephine w/.078mm Extension & 8mm Well
- 8-17007 Huang 9.5mm LASEK Trephine w/.090mm Extension & 10mm Well



B

- B)** 8-17008 Huang Epithelial LASEK Hoe
- C)** 8-17009 LASEK 10mm Alcohol Well
- 8-17010 LASEK 8.5mm Alcohol Well
- 8-17011 LASEK 9.5mm Alcohol Well

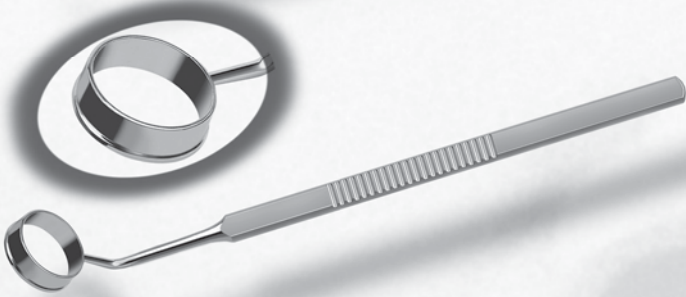

C

- D)** 8-17013 LASEK 8.0mm Epithelial Trephine, .242mm Extension
- 8-17014 LASEK 9.0mm Epithelial Trephine, .242mm Extension



D

- E)** 8-17015 LASEK 8.5mm Alcohol Well & 8.0mm Epithelial Trephine, .242mm Extension
- 8-17016 LASEK 9.5mm Alcohol Well & 9.0mm Epithelial Trephine, .242mm Extension

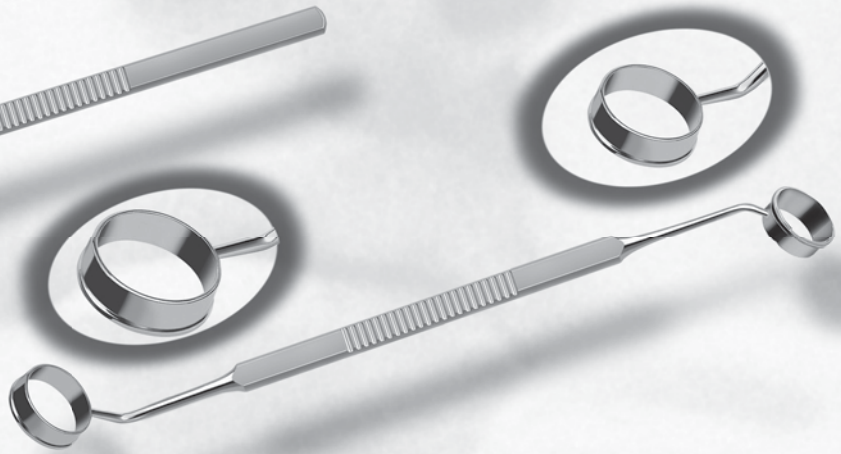

E



ELEVATING THE QUALITY OF CARE IN OPHTHALMOLOGY
800-637-4346



1-800-263-3557

LASEK INSTRUMENTS

18.03

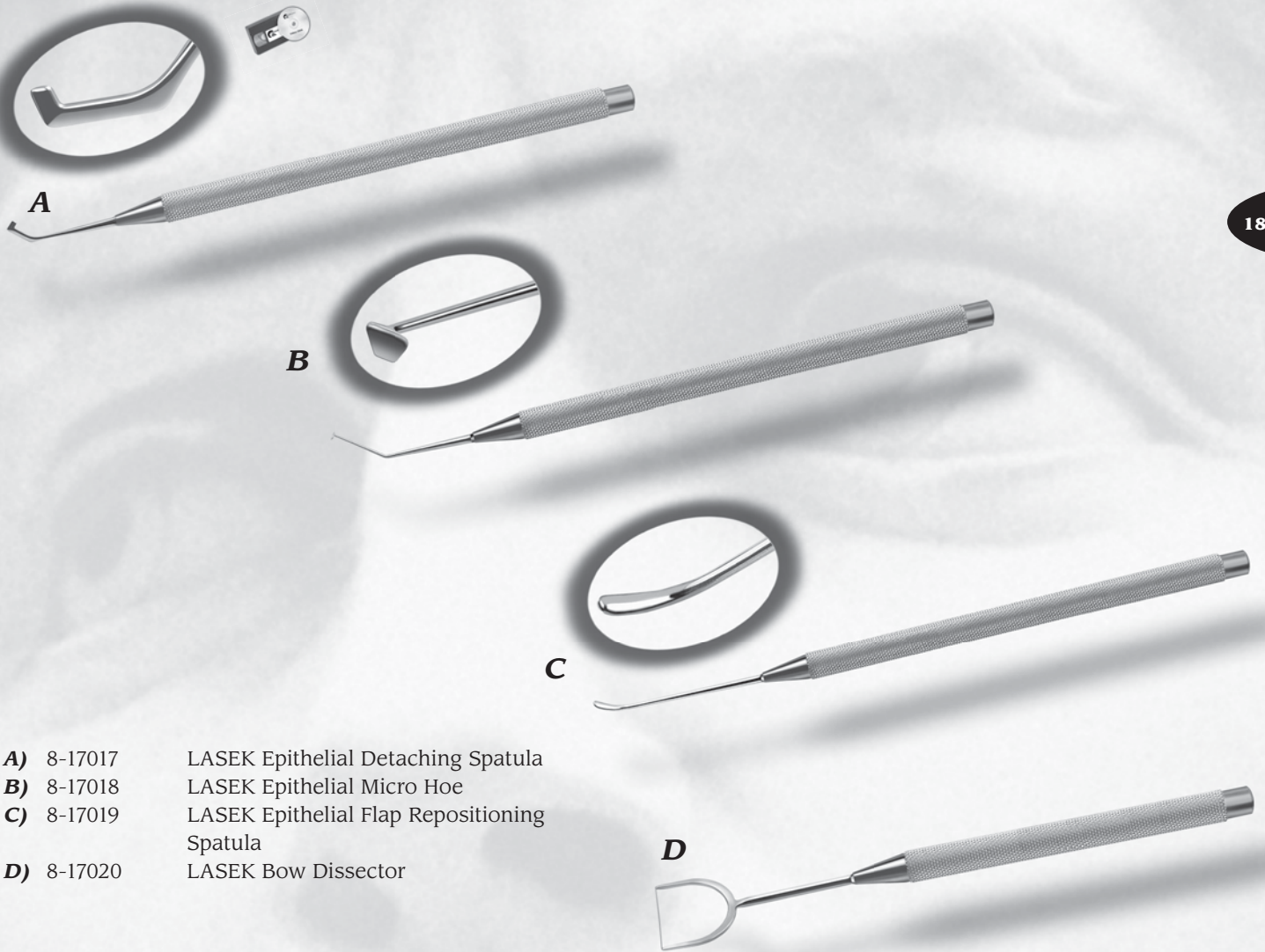

- A)** 8-17017 LASEK Epithelial Detaching Spatula
- B)** 8-17018 LASEK Epithelial Micro Hoe
- C)** 8-17019 LASEK Epithelial Flap Repositioning Spatula
- D)** 8-17020 LASEK Bow Dissector



ELEVATING THE QUALITY



ACOR

1-800-263-3557



MANUAL LENS FRAGMENTATION

19.00

- **Lens Cutters**
- **Nucleus Fragmentation**

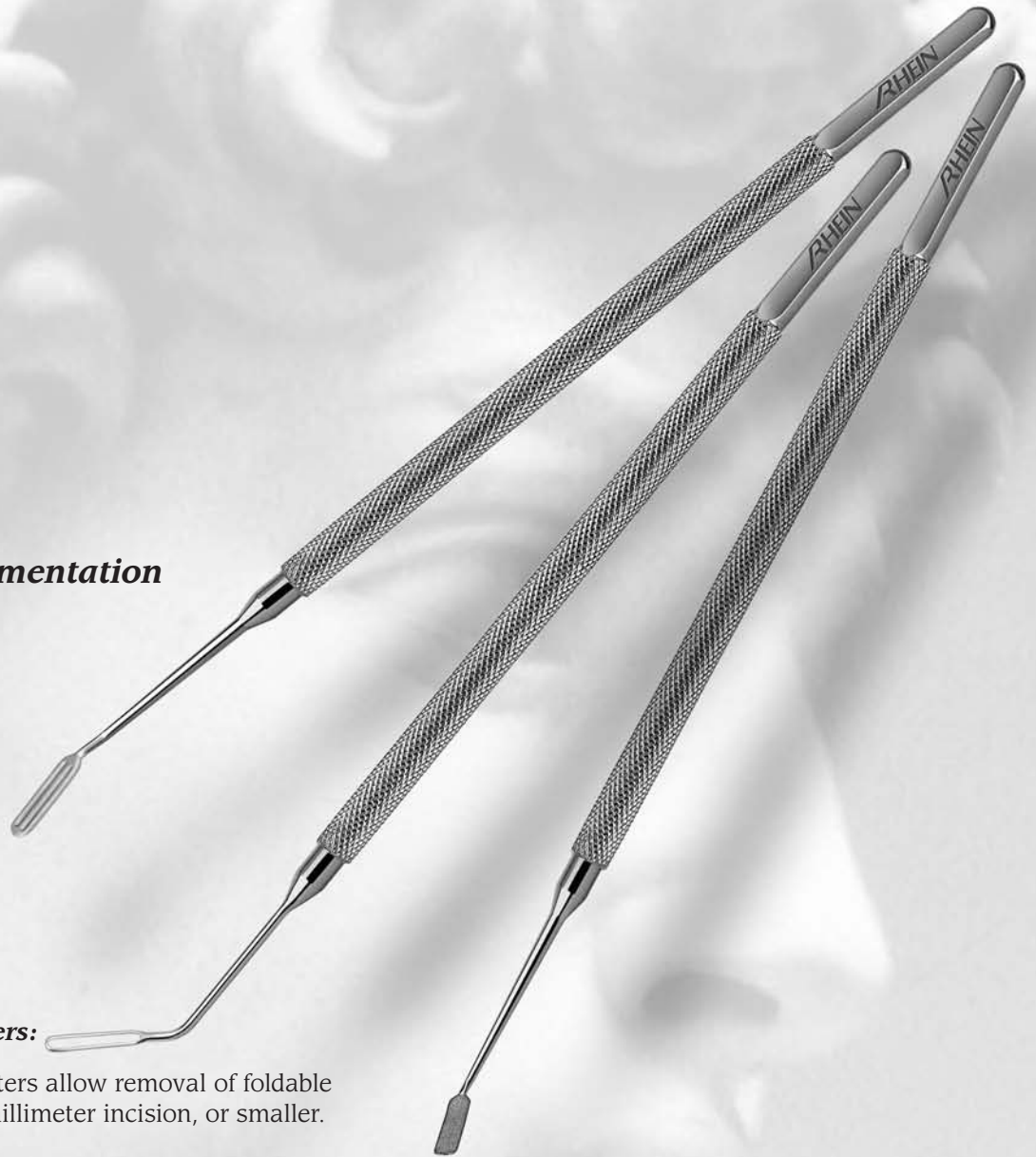

Foldable Lens Cutters:

Our foldable lens cutters allow removal of foldable lenses through a 3-millimeter incision, or smaller.

Nucleus Splitters:

Non-actuating nucleus splitters are used through the paracentesis. Actuating nucleus splitters are used through the phaco incision. These are angled on the side during insertion and removal. After sculpting the nucleus with a single groove of the phaco tip, adjust the splitter to the upright position and actuate the handles to place equal opposing pressure on the nucleus walls for a clean and atraumatic fracture of the nucleus.



ELEVATING THE QUALITY OF CARE IN OPHTHALMOLOGY
800-637-4346



MANUAL LENS FRAGMENTATION

Lens Cutters

19.01



A

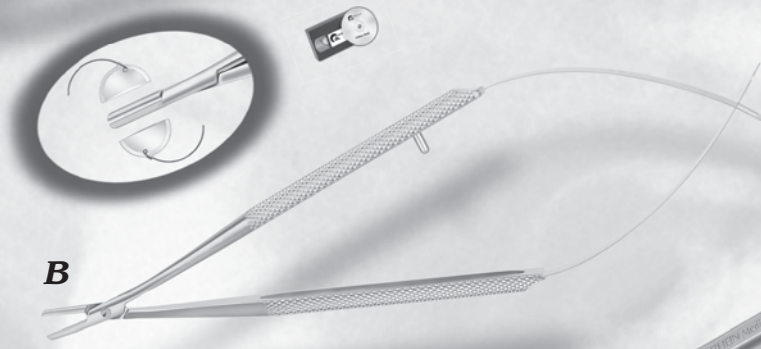

B

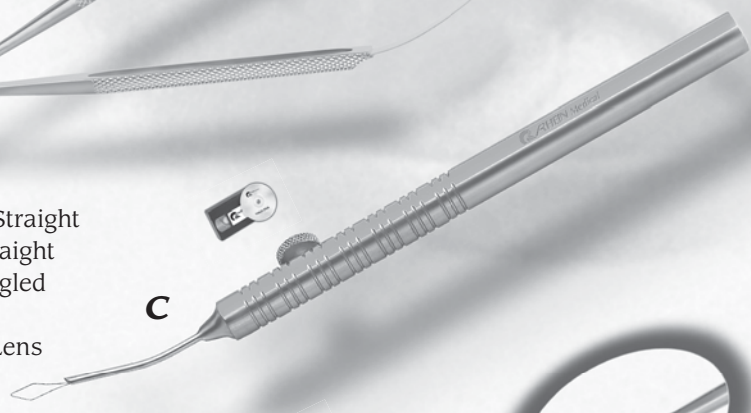

C

- A)** 8-14560 Brown Silicone Lens Cutter, Straight
- B)** 8-14522-S Chu Foldable Lens Cutter, Straight
- 8-14522 Chu Foldable Lens Cutter, Angled
- C)** 8-14513 Utrata Foldable Lens Cutter
- 8-14514 Wire Snare Loop For Utrata Lens Cutter (One)
- 8-14515 Wire Snare Loop For Utrata Lens Cutter (Five)

Lens Cutters

Nucleus Fragmentation

- D)** 8-14523 Kellan Nucleus Dissection Spatula
- E)** 8-14524 Kellan Nucleus Elevation Spatula
- F)** 8-14525 Kellan Nucleus Manipulator

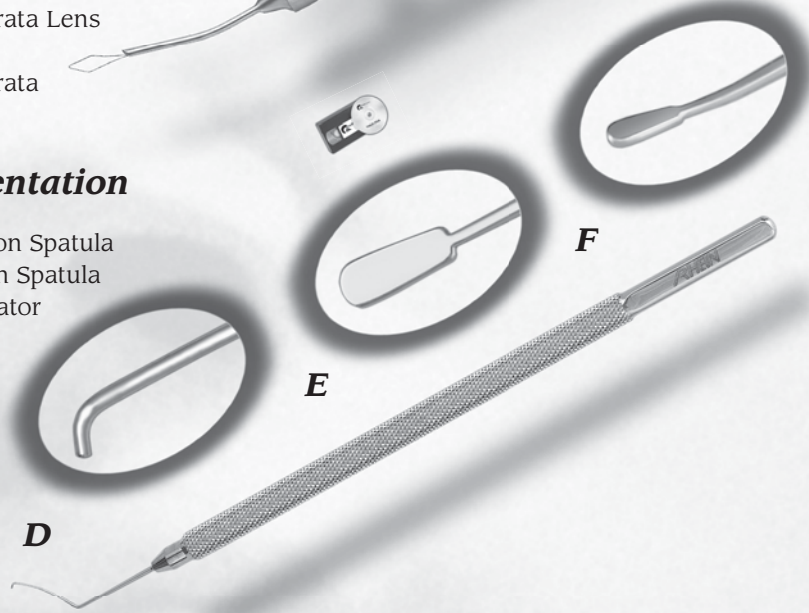

D

E

F



MANUAL LENS FRAGMENTATION

Nucleus Fragmentation

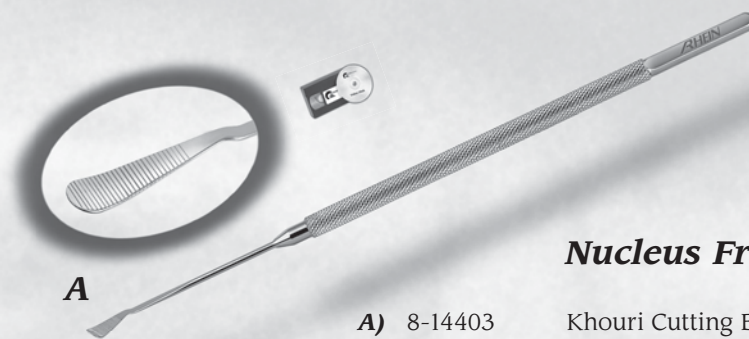

A

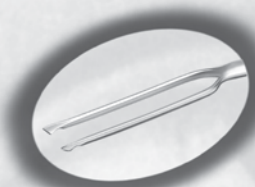

B

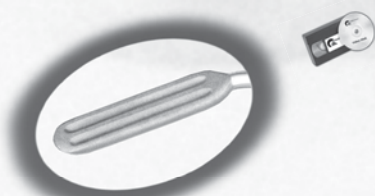

C



D

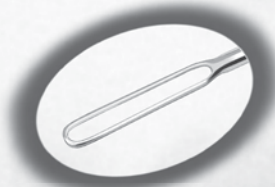

E

Nucleus Fragmentation

- A)** 8-14403 Khouri Cutting Board, Right Hand Dominant Surgeon
- 8-14401 Khouri Phacofragmentation System, Right Hand Dominant
- 8-14402 Khouri Phacofragmentation System, Left Hand Dominant
- 8-14404 Khouri Cutting Board, Left Hand Dominant Surgeon
- B)** 8-14405 Khouri Cutting Fork, Right Hand Dominant Surgeon
- 8-14406 Khouri Cutting Fork, Left Hand Dominant Surgeon
- C)** 8-14202-R McIntyre II Cutting Board-Right Hand Dominant Surgeon
- 8-14202-L McIntyre II Cutting Board-Left Hand Dominant Surgeon
- 8-14200-L McIntyre II Splitting/Removal System-Right Hand Dominant-4.5mm Spoon
- 8-14200-S McIntyre II Splitting/Removal System-Right Hand Dominant-3mm Spoon
- 8-14201-L McIntyre II Splitting/Removal System-Left Hand Dominant-4.5mm Spoon
- 8-14201-S McIntyre II Splitting/Removal System-Left Hand Dominant-3mm Spoon
- D)** 8-14204-R McIntyre II Single Cleaver - Right Hand Dominant Surgeon
- 8-14204-L McIntyre II Single Cleaver - Left Hand Dominant Surgeon
- E)** 8-14205-R McIntyre II Double Cleaver - Right Hand Dominant Surgeon
- 8-14205-L McIntyre II Double Cleaver - Left Hand Dominant Surgeon

19.02



ELEVATING THE QUALITY OF CARE IN OPHTHALMOLOGY
800-637-4346



1-800-263-3557

MANUAL LENS FRAGMENTATION

Nucleus Fragmentation

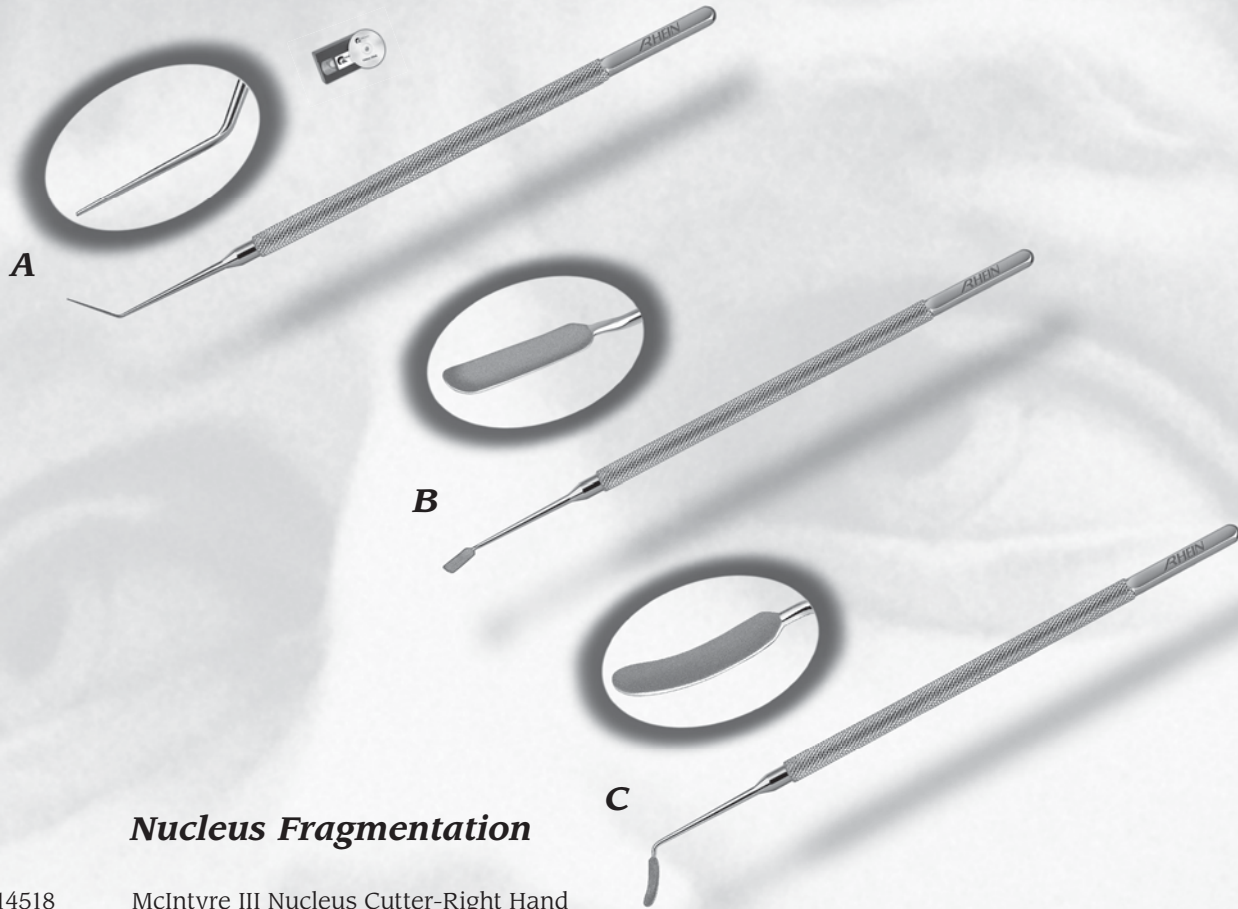

19.03

Nucleus Fragmentation

- A)** 8-14518 McIntyre III Nucleus Cutter-Right Hand Dominant Surgeon
8-14518-L McIntyre III Nucleus Cutter-Left Hand Dominant Surgeon
- B)** 8-14519 McIntyre III Nucleus Cutting Spatula-Right Hand Dominant Surgeon
8-14519-L McIntyre III Nucleus Cutting Spatula-Left Hand Dominant Surgeon
- C)** 8-14520 McIntyre III Fragment Extractor-Right Hand Dominant Surgeon
8-14520-L McIntyre III Fragment Extractor-Left Hand Dominant Surgeon



ELEVATING THE QUALITY

ACOR

1-800-263-3557

MISCELLANEOUS INSTRUMENTS

20.00



ELEVATING THE QUALITY OF CARE IN OPHTHALMOLOGY
800-637-4346



1-800-263-3557

MISCELLANEOUS INSTRUMENTS

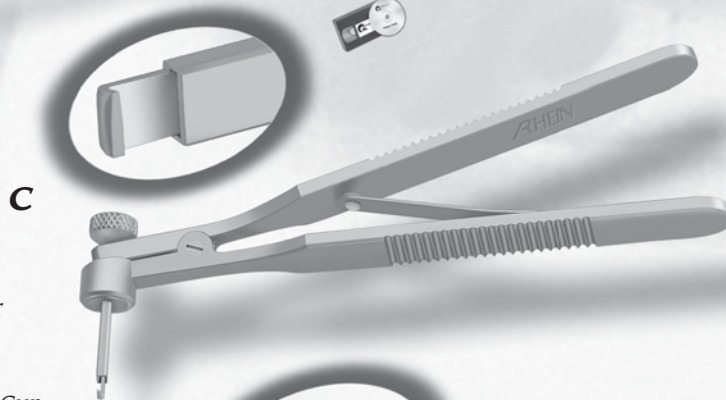
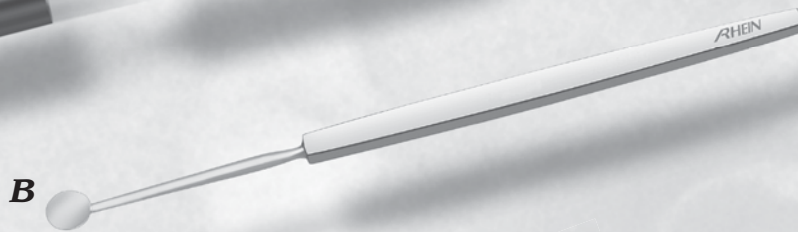
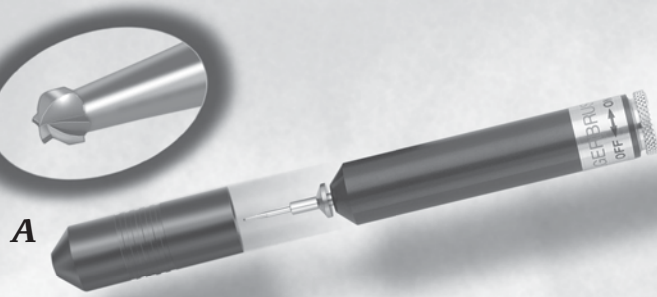

- A)** 8-13140 Alger Brush
- 8-13141 1mm Burr For Alger Brush
- B)** 8-13101 Bunge Evisceration Spoon, Small 8mm Cup
- 8-13102 Bunge Evisceration Spoon, Large 11mm Cup
- C)** 8-13002 Carpel One-Step Trabeculectomy Punch
- D)** 8-13223 Gass Retinal Detachment Hook, Flattened w/Oblong Hole
- 8-13226 Gass Scleral Marker, 2.0mm Diameter Marking Tip
- E)** 8-13225* Gillum Retrobulbar Guide



*Retrobulbar Not Included

20.01



ELEVATING THE QUALITY



1-800-263-3557



MISCELLANEOUS INSTRUMENTS

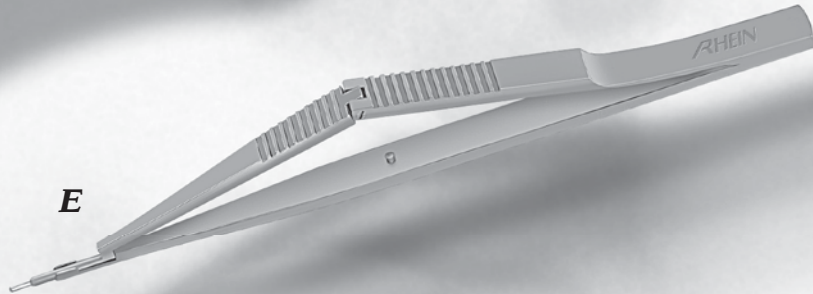
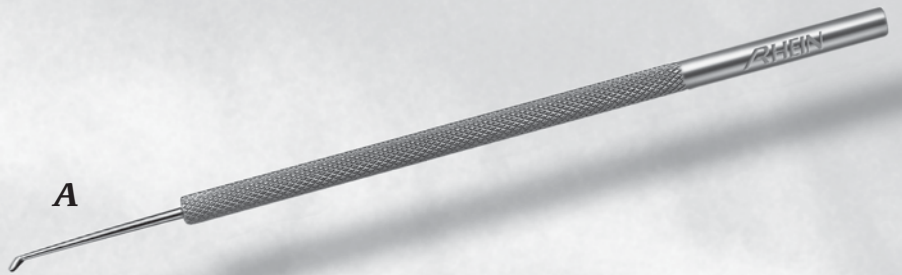

- A) 8-13139 Golf Club Spud
- B) 85-9002 Jaffe Bone Plate, 11cm x 20mm, 1mm Thick
- C) 85-9004 Jaffe Eye Shield
- D) 85-9001 Jaffe Mouth Guard
- E) 8-13000 Kelly Descemet's Punch

20.02



ELEVATING THE QUALITY OF CARE IN OPHTHALMOLOGY
800-637-4346



1-800-263-3557

MISCELLANEOUS INSTRUMENTS

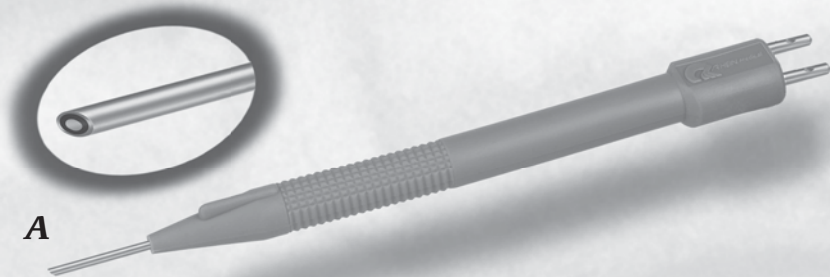

A

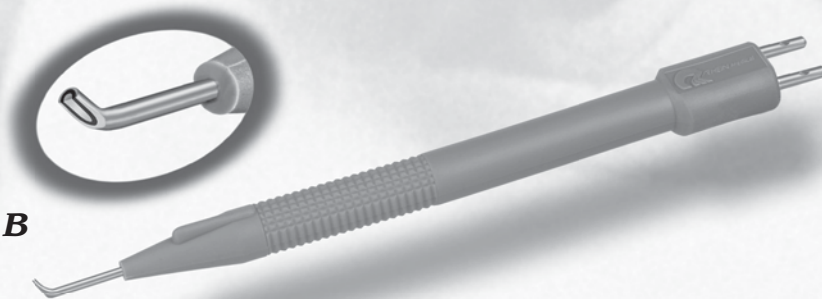

B

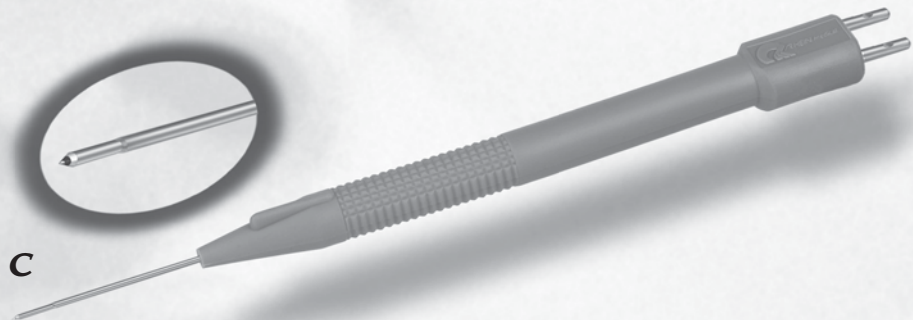

C

- A)** 8-13200 Reusable 18 Gauge Cautery Pen, 45 Degree Bevel
- B)** 8-13205 Reusable 18 Gauge Cautery Pen, Dual Broad Tip
- C)** 8-13210 Reusable 23 Gauge Cautery Pen, Tapered Tip

20.03



ELEVATING THE QUALITY



1-800-263-3557



MISCELLANEOUS INSTRUMENTS

20.04

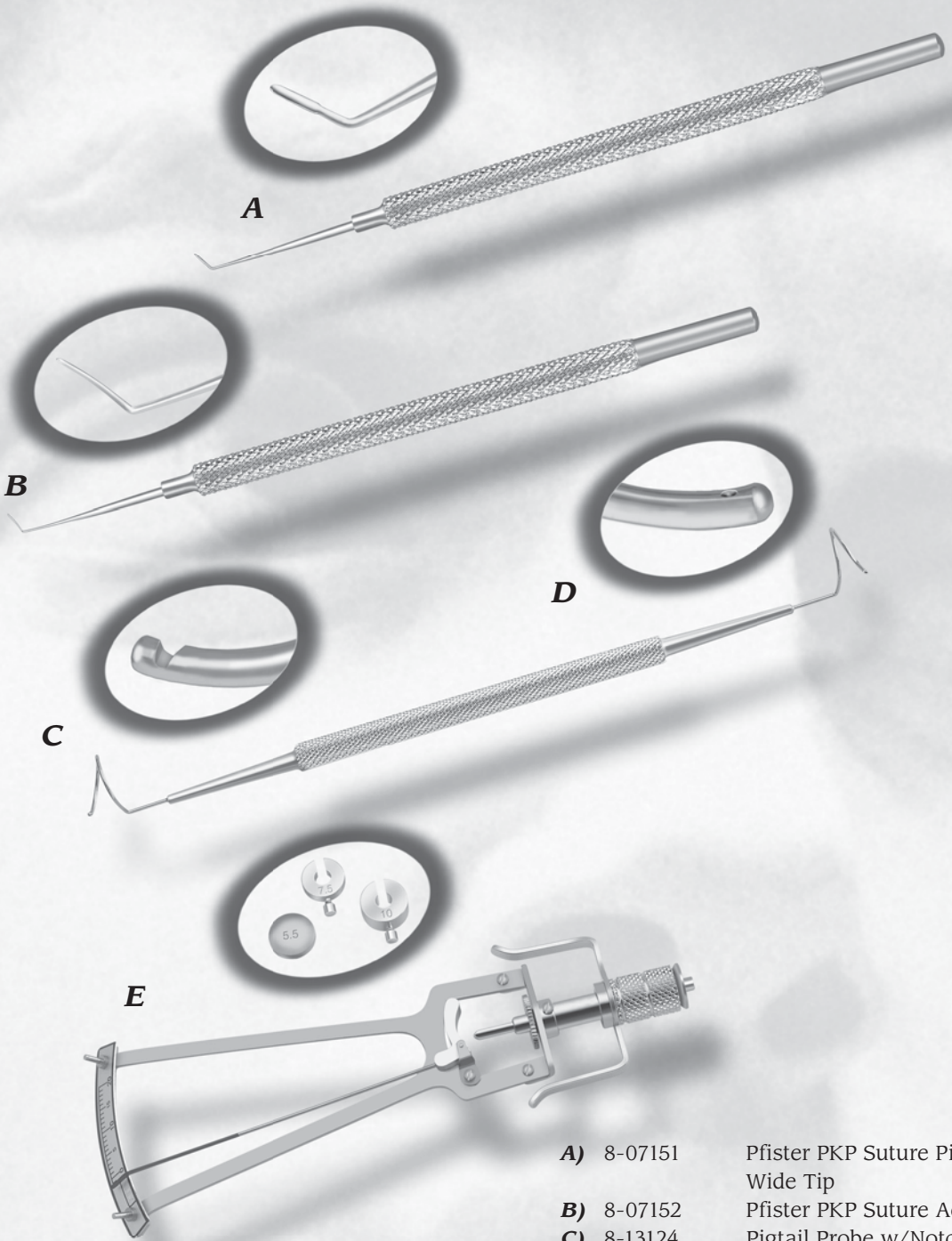

- A)** 8-07151 Pfister PKP Suture Pincher, Wide Tip
- B)** 8-07152 Pfister PKP Suture Adjuster, Thin Tip
- C)** 8-13124 Pigtail Probe w/Notches
- D)** 8-13125 Pigtail w/Suture Holes
- E)** 8-13114 Schiotz Tonometer, Original Model w/3 Weights, 5.5, 7.5, 10 Grams
- 8-13115 Same As #8-13114 w/Allen Plunger Retractor
- 8-13116 Improved Model w/4 Weights, 5.5, 7.5, 10, 15 Grams
- 8-13117 Intraocular Retractor
- 8-13224 Suture W



ELEVATING THE QUALITY OF CARE IN OPHTHALMOLOGY
800-637-4346

1-800-263-3557

MISCELLANEOUS INSTRUMENTS

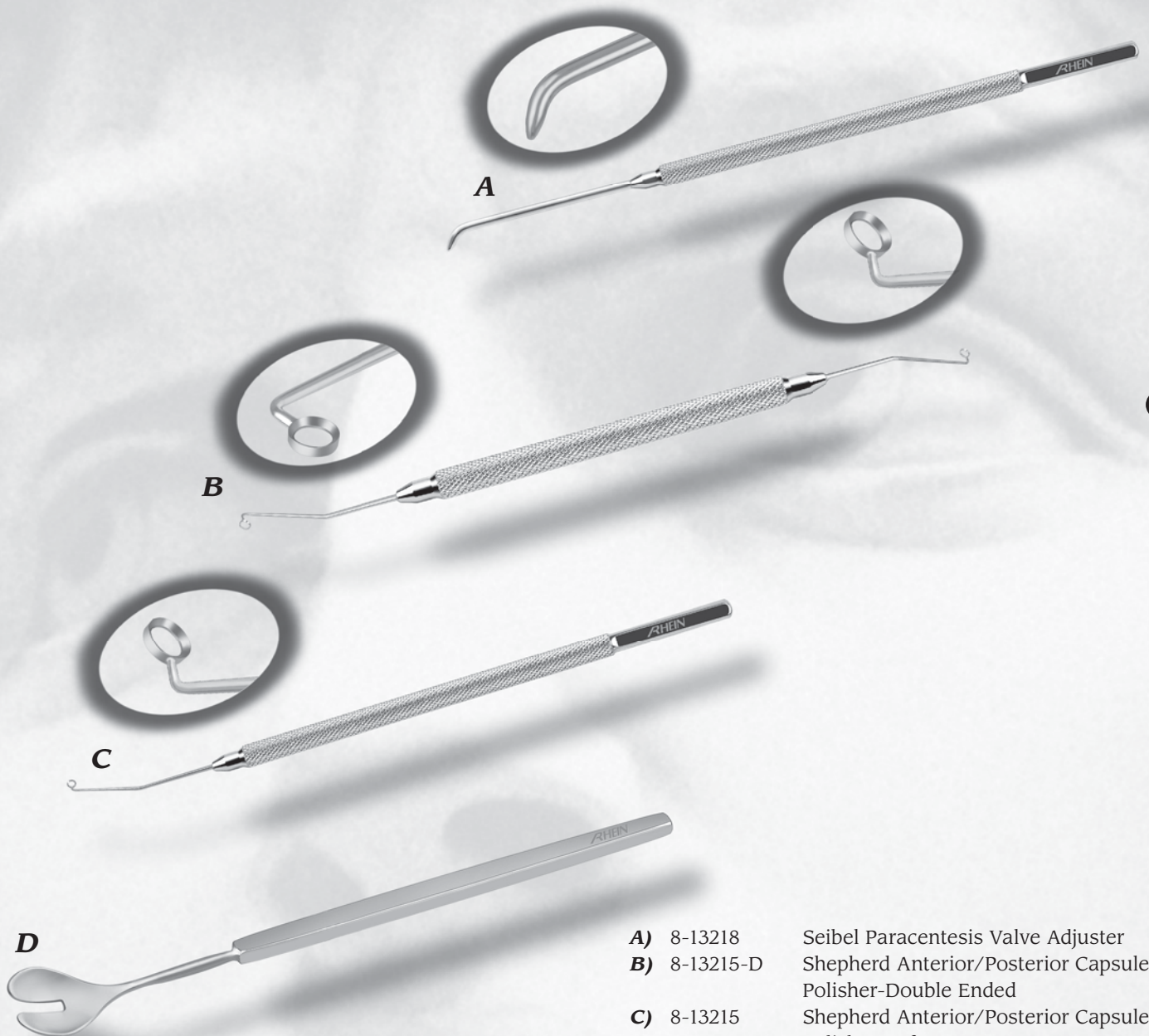

20.05

- A)** 8-13218 Seibel Paracentesis Valve Adjuster
- B)** 8-13215-D Shepherd Anterior/Posterior Capsule Polisher-Double Ended
- C)** 8-13215 Shepherd Anterior/Posterior Capsule Polisher-Left
- 8-13214 Shepherd Anterior/Posterior Capsule Polisher-Right
- D)** 8-13103 Wells Enucleation Spoon 6", Cup 21mm



1-800-263-3557

NEEDLE HOLDERS

- **Stainless Needle Holders-21.01**
- **Titanium Needle Holders-21.03**

Needle Holders:

Our titanium needle holders have a flat ridge along the spine of the handle. This ridge offers the combined advantages of a flat handle for stability and tactile feedback, along with the benefits of a round handle for uninterrupted rotation. Our locks are recessed into the hollowed handles to help protect the mechanism during handling and sterilization. The recessed locks allow complete closure of the instrument when in the locked position, resulting in a cylindrical handle for better rotation. The jaws of our needle holders are impregnated with tungsten carbide to improve grip over sutures and needles. Titanium is non-magnetic, so the needle will never stick to the jaws.

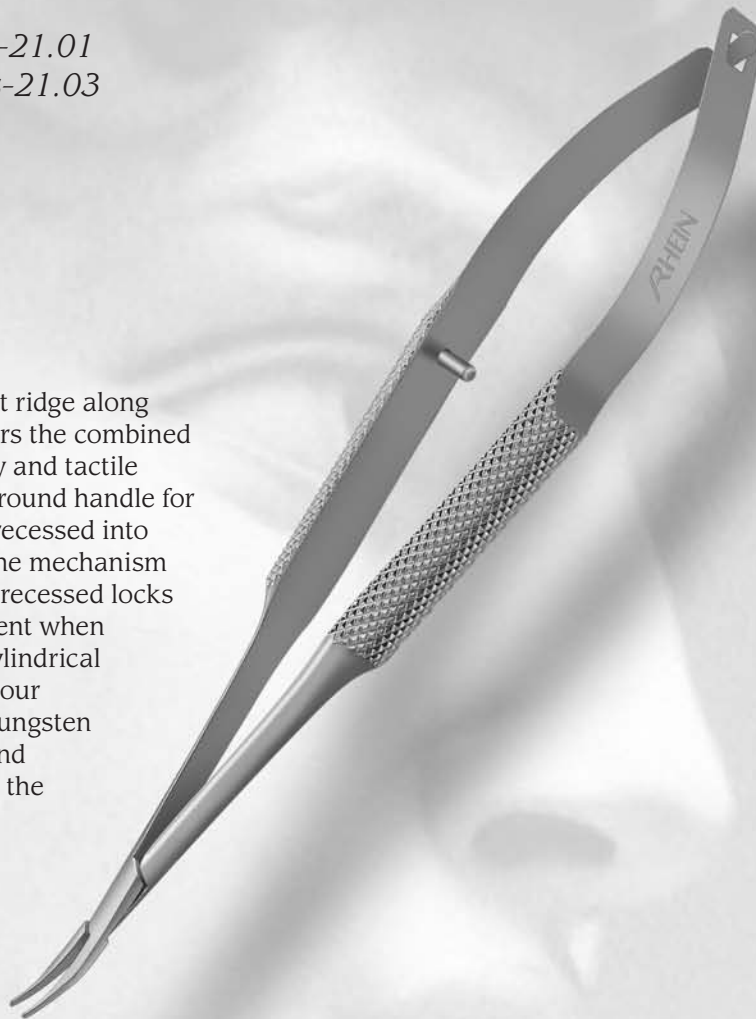

21.00



ELEVATING THE QUALITY OF CARE IN OPHTHALMOLOGY
800-637-4346



NEEDLE HOLDERS

Stainless Needle Holders

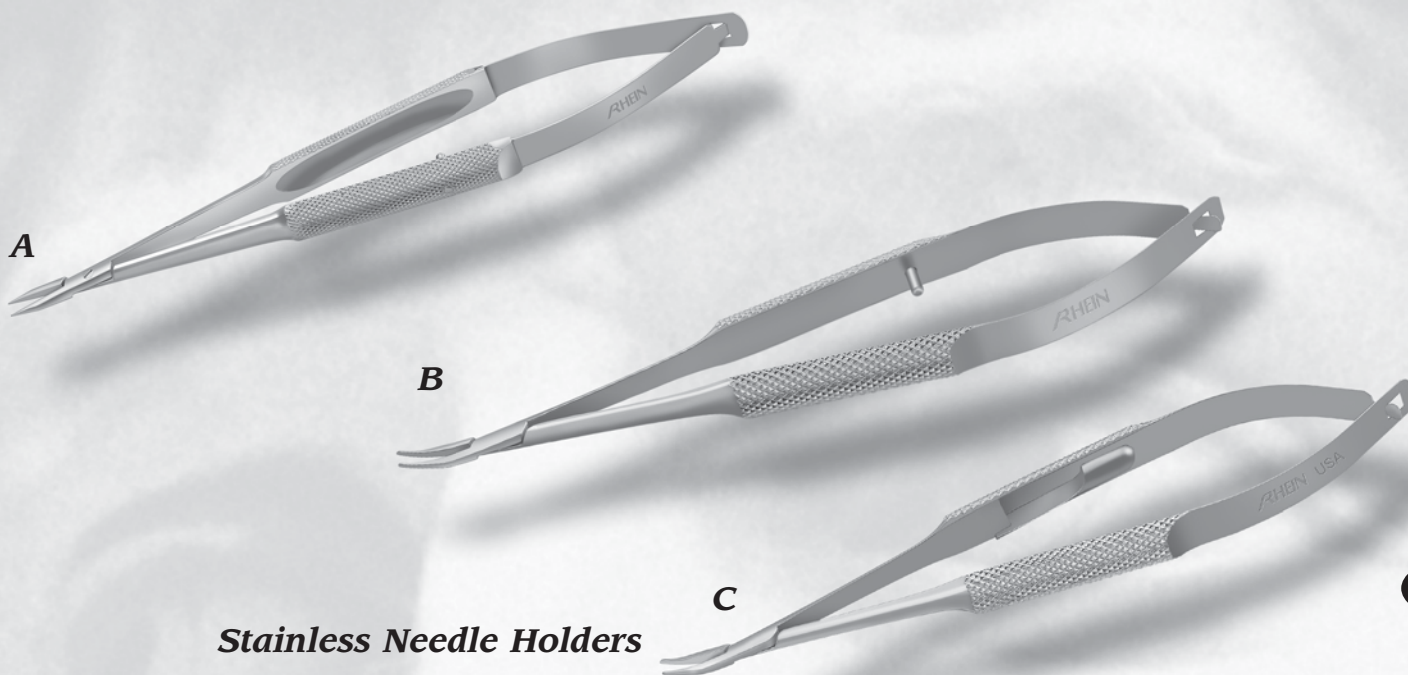

Stainless Needle Holders

- A)** 8-02156 Anis Straight w/o Lock X-Delicate
- 8-02155 Anis Straight w/Lock X-Delicate
- 8-02157 Anis Curved w/Lock X-Delicate
- 8-02158 Anis Curved w/o Lock X-Delicate
- B)** 8-02112 Barraquer Delicate, Curved w/o Lock, 12.5cm
- 8-02111 Barraquer Delicate, Curved w/Lock, 12.5cm
- 8-02113 Barraquer Delicate, Straight w/Lock, 12.5cm
- 8-02114 Barraquer Delicate, Straight w/o Lock, 12.5cm
- 8-02117 Barraquer Delicate, Curved w/o Lock, 11.5cm
- 8-02120 Barraquer, Delicate, Curved w/Lock, 11.5cm
- C)** 8-02118 Barraquer Standard, Curved w/Lock, 13cm
- 8-02119 Barraquer Standard, Curved w/o Lock, 13cm
- 8-02116 Barraquer Standard, Straight w/Lock, 13cm
- 8-02115 Barraquer Standard, Straight w/o Lock, 13cm

21.01



ELEVATING THE QUALITY



1-800-263-3557



NEEDLE HOLDERS

Stainless Needle Holders

Stainless Needle Holders

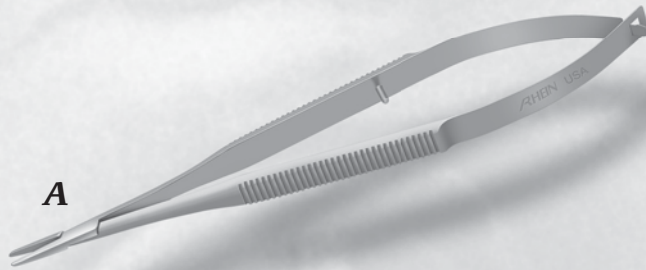

A

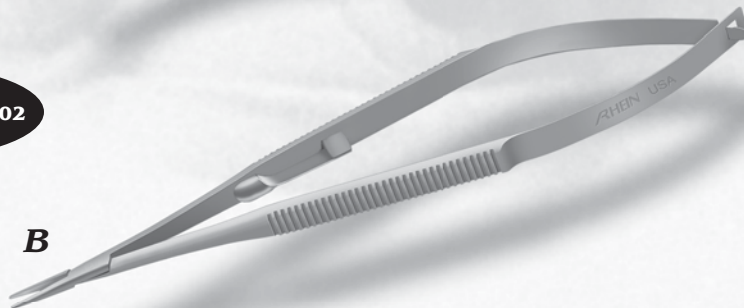

B

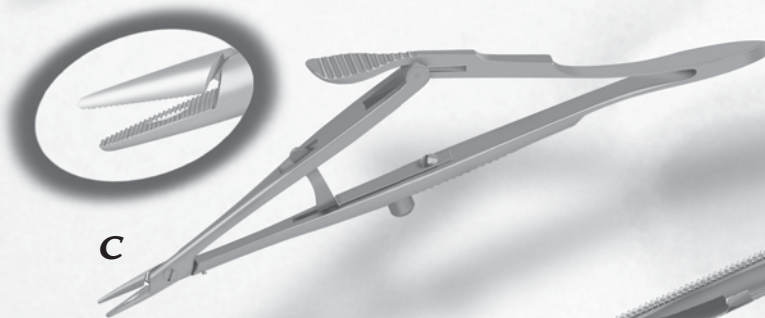

C

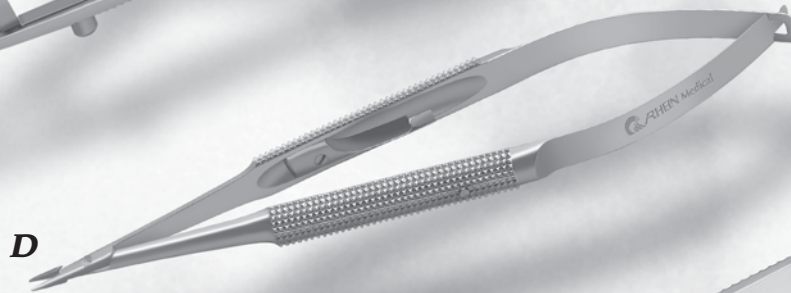

D

- A)** 8-02133 Castroviejo 5-1/2", Straight w/o Lock
- 8-02136 Castroviejo 5-1/2", Curved w/Lock
- 8-02134 Castroviejo 5-1/2", Curved w/o Lock
- 8-02135 Castroviejo 5-1/2", Straight w/Lock
- B)** 8-02127 Castroviejo Delicate, Curved w/Lock
- 8-02128 Castroviejo Delicate, Curved w/o Lock
- 8-02125 Castroviejo Delicate, Straight w/Lock
- 8-02126 Castroviejo Delicate, Straight w/o Lock
- C)** 8-02153 Kalt 5-1/4", Standard, Delicate Jaws
- D)** 8-02148 McIntyre, Straight w/Lock
- E)** 8-02103 McPherson X-Delicate, Curved w/Lock
- 8-02104 McPherson X-Delicate, Curved w/o Lock
- 8-02101 McPherson X-Delicate, Straight w/Lock
- 8-02102 McPherson X-Delicate, Straight w/o Lock

21.02



ELEVATING THE QUALITY OF CARE IN OPHTHALMOLOGY
800-637-4346



1-800-263-3557

NEEDLE HOLDERS

Titanium Needle Holders

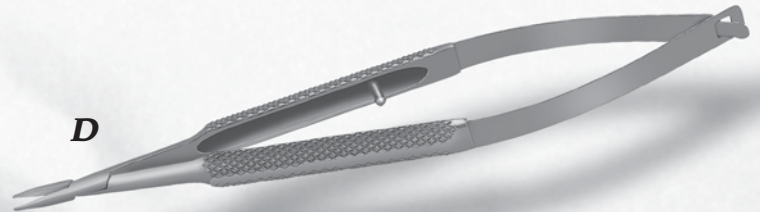
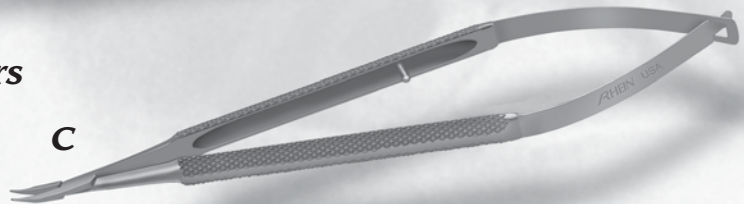
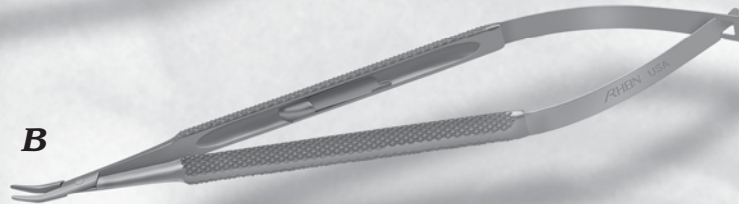
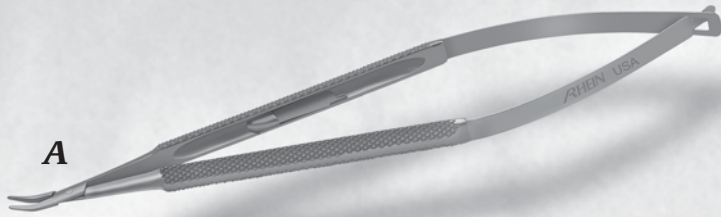

Titanium Needle Holders

- A)** 05-1019 Curved, w/Lock, Standard Jaws, 5-1/2" - Titanium
- 05-1018 Curved, w/o Lock, Standard Jaws, 5-1/2" - Titanium
- 05-1022 Straight, w/o Lock, Standard Jaws, 5-1/2" - Titanium
- 05-1023 Straight, w/Lock, Standard Jaws, 5-1/2" - Titanium
- B)** 05-1038 Curved, w/o Lock, Delicate Jaws, 5-1/2" - Titanium
- 05-1030 Curved, w/o Lock, Delicate Jaws, 4-1/4" - Titanium
- 05-1031 Curved, w/Lock, Delicate Jaws, 4-1/4" - Titanium
- 05-1039 Curved, w/Lock, Delicate Jaws, 5-1/2" - Titanium
- C)** 05-1010 Curved, w/o Lock, Standard Jaws, 4-1/4" - Titanium
- 05-1011 Curved, w/Lock, Standard Jaws, 4-1/4" - Titanium
- 05-1014 Straight, w/o Lock, Standard Jaws, 4-1/4" - Titanium
- 05-1015 Straight, w/Lock, Standard Jaws, 4-1/4" - Titanium
- D)** 05-1026 Straight, w/o Lock, Delicate Jaws, 4-1/4" - Titanium
- 05-1027 Straight, w/Lock, Delicate Jaws, 4-1/4" - Titanium
- 05-1034 Straight, w/o Lock, Delicate Jaws, 5-1/2" - Titanium
- 05-1035 Straight, w/Lock, Delicate Jaws, 5-1/2" - Titanium

21.03



ELEVATING THE QUALITY



1-800-263-3557



PRK, LASIK & INTRALASE INSTRUMENTS

- **Applanation**-22.01
- **Forceps**-22.01
- **Fixation**-22.02
- **Intralase**-22.03
- **Markers**-22.04
- **Miscellaneous**-22.06
- **Retreatment Hooks**-22.07
- **Spatulas**-22.08



22.00



ELEVATING THE QUALITY OF CARE IN OPHTHALMOLOGY
800-637-4346



1-800-263-3557

PRK, LASIK & INTRALASE INSTRUMENTS

Applanation

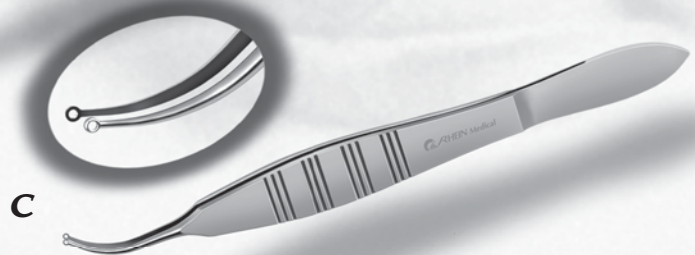
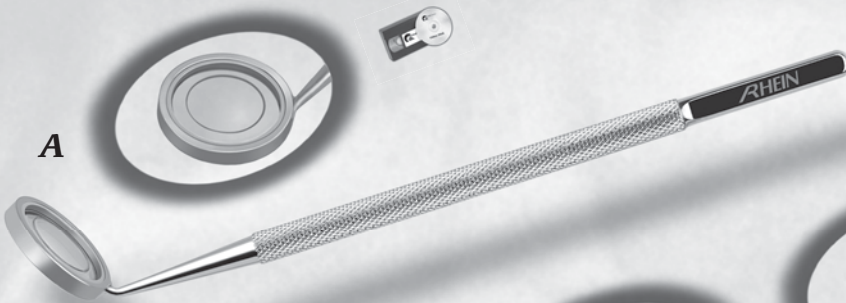

Applanation

- A) 8-16149 Johnston LASIK Flap Applanator-Stainless
- 05-7003 Johnston LASIK Flap Applanator-Titanium

Forceps

- B) 8-16161 Kershner LASIK Flap Forceps
- C) 8-16163 Rhein LASIK Flap Forceps, Curved On Side Of Handle, Holes
- D) 8-16162 Rhein LASIK Flap Forceps, Curved Toward Handle, Holes
- E) 8-16152 Rhein Lasik Flap Forceps, Solid Blades

22.01



ELEVATING THE QU



1-800-263-3557



PRK, LASIK & INTRALASE INSTRUMENTS

Fixation

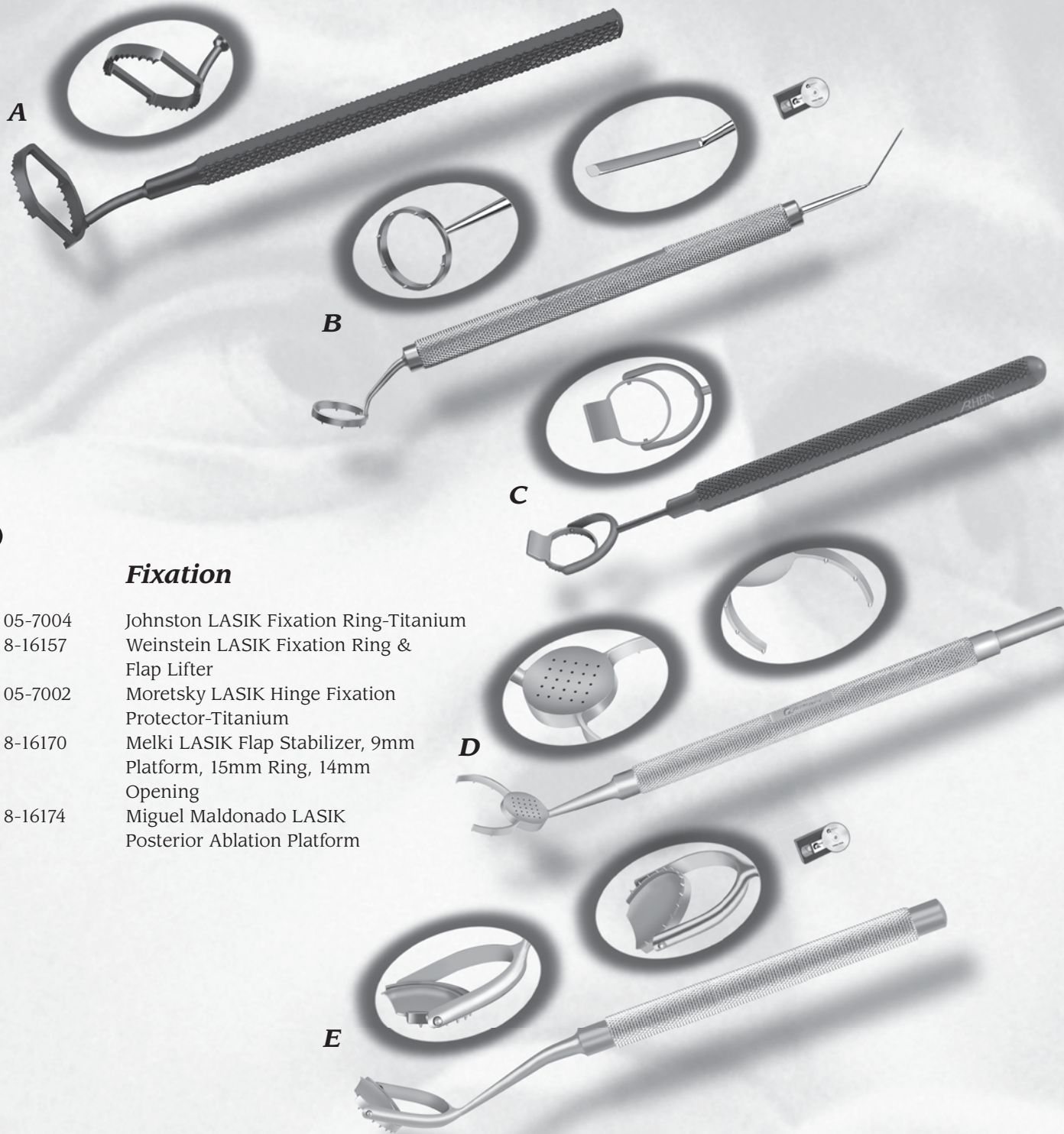

22.02

Fixation

- A)** 05-7004 Johnston LASIK Fixation Ring-Titanium
- B)** 8-16157 Weinstein LASIK Fixation Ring & Flap Lifter
- C)** 05-7002 Moretsky LASIK Hinge Fixation Protector-Titanium
- D)** 8-16170 Melki LASIK Flap Stabilizer, 9mm Platform, 15mm Ring, 14mm Opening
- E)** 8-16174 Miguel Maldonado LASIK Posterior Ablation Platform



ELEVATING THE QUALITY OF CARE IN OPHTHALMOLOGY
800-637-4346



PRK, LASIK & INTRALASE INSTRUMENTS

Intralase

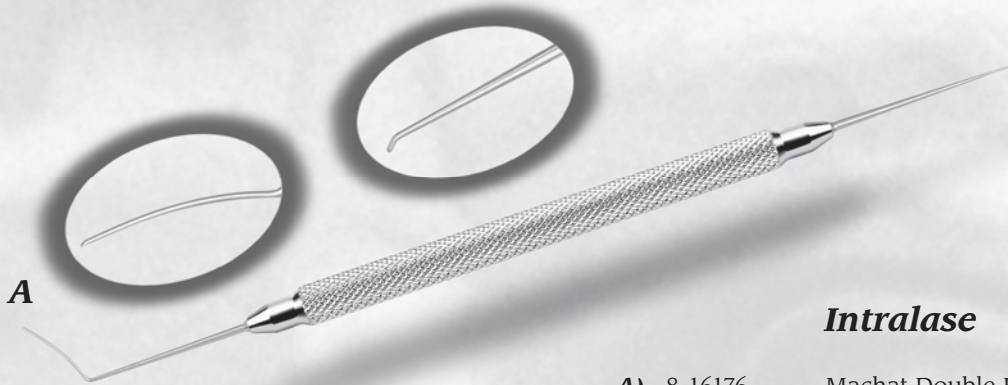

Intralase

- A) 8-16176 Machat Double Ended Intralase Spatula w/45 Degree Sinsky
- B) 8-16173 Rousseau IntraLase Flap Spreader
- C) 8-16172 Seibel IntraLase Flap Lifter & Retreatment Spatula
- D) 05-7007 Seibel IntraLase Flap Lifter & Retreatment Spatula, Titanium

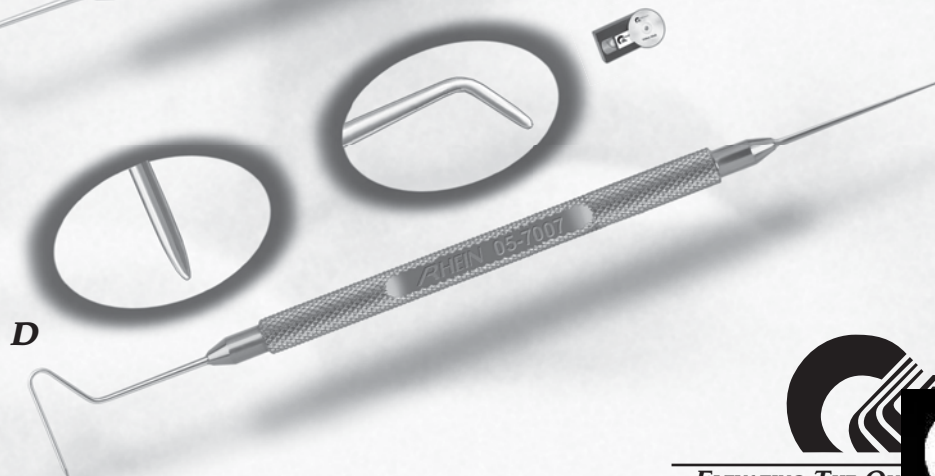

22.03

PHEN Medical

ELEVATING THE QU



1-800-263-3557

PRK, LASIK & INTRALASE INSTRUMENTS

Markers

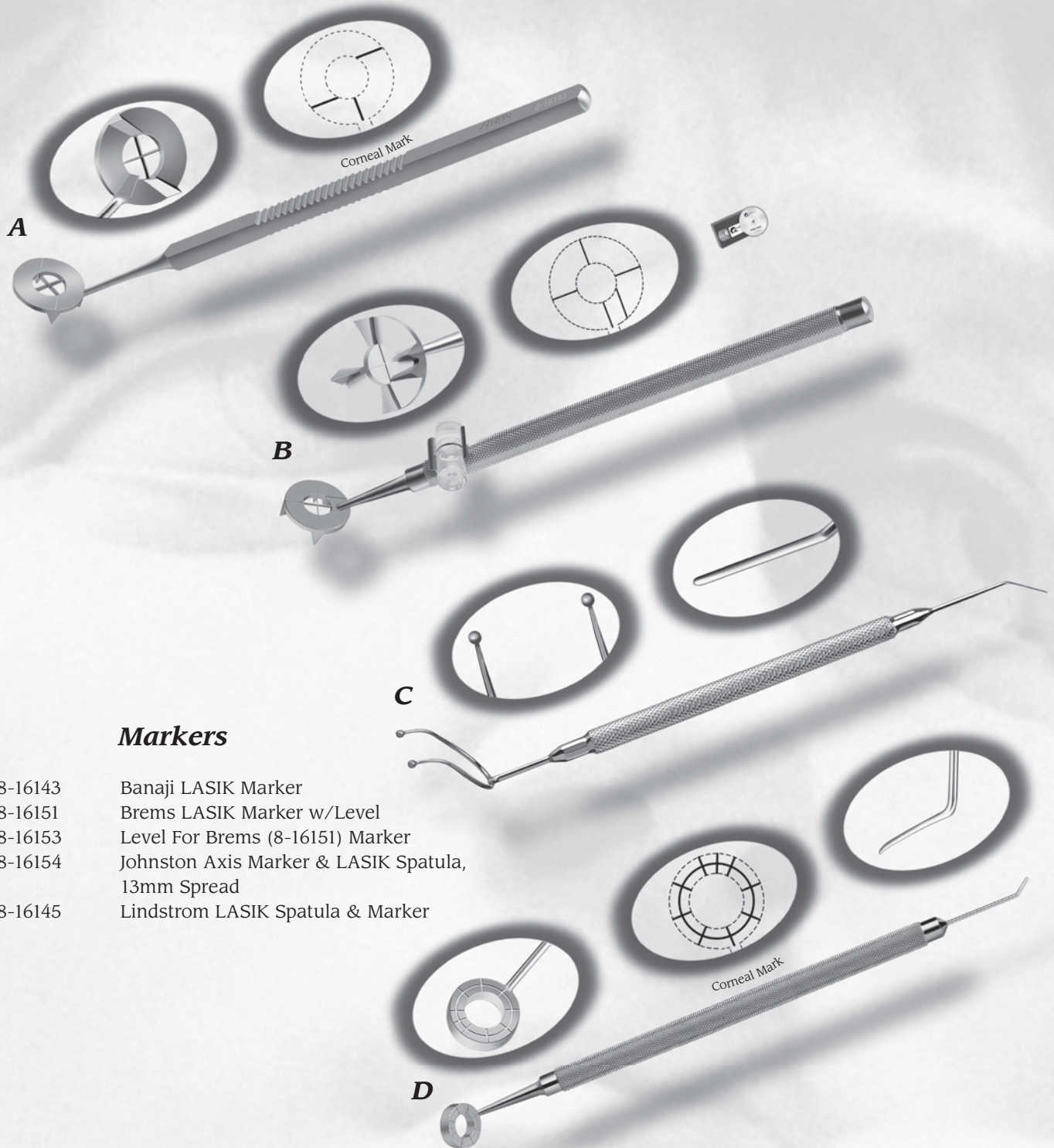

Markers

- A)** 8-16143 Banaji LASIK Marker
- B)** 8-16151 Brems LASIK Marker w/Level
8-16153 Level For Brems (8-16151) Marker
- C)** 8-16154 Johnston Axis Marker & LASIK Spatula,
13mm Spread
- D)** 8-16145 Lindstrom LASIK Spatula & Marker



ELEVATING THE QUALITY OF CARE IN OPHTHALMOLOGY
800-637-4346



PRK, LASIK & INTRALASE INSTRUMENTS

Markers

22.05

Markers

- A) 8-16144 Lindstrom PRK Spatula & 7mm Marker
- B) 8-16150 Pettigrove LASIK Marker
- C) 8-16160 Phillips Gravity Axis Marker, 10mm ID, 14mm OD
- D) 8-16156 Spivack Axis Marker, 11.5mm Spread
- E) 8-16147 Steinert LASIK Marker

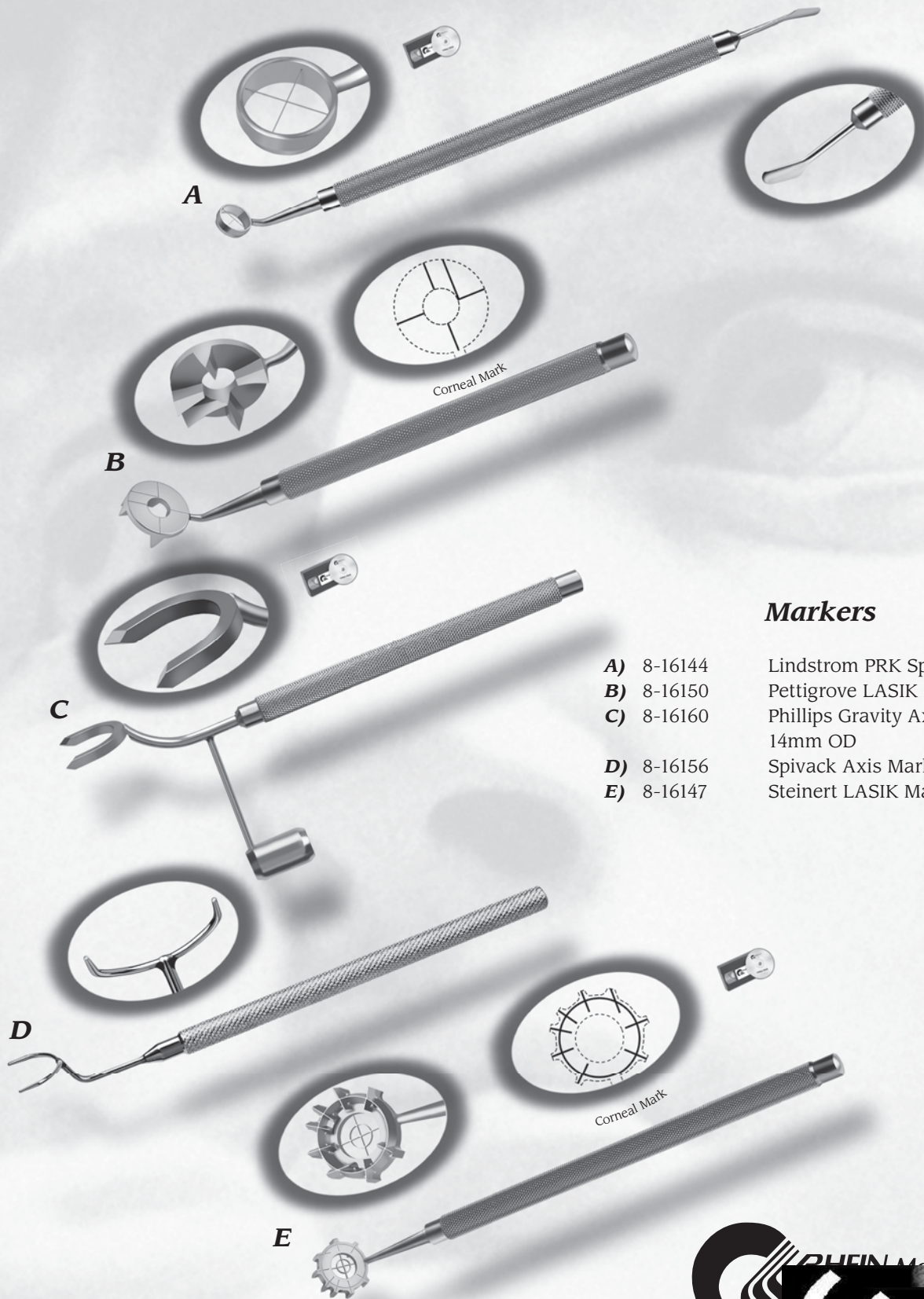

PHENIX Medical

ELEVATING THE QUALITY



1-800-263-3557

PRK, LASIK & INTRALASE INSTRUMENTS

Miscellaneous

22.06

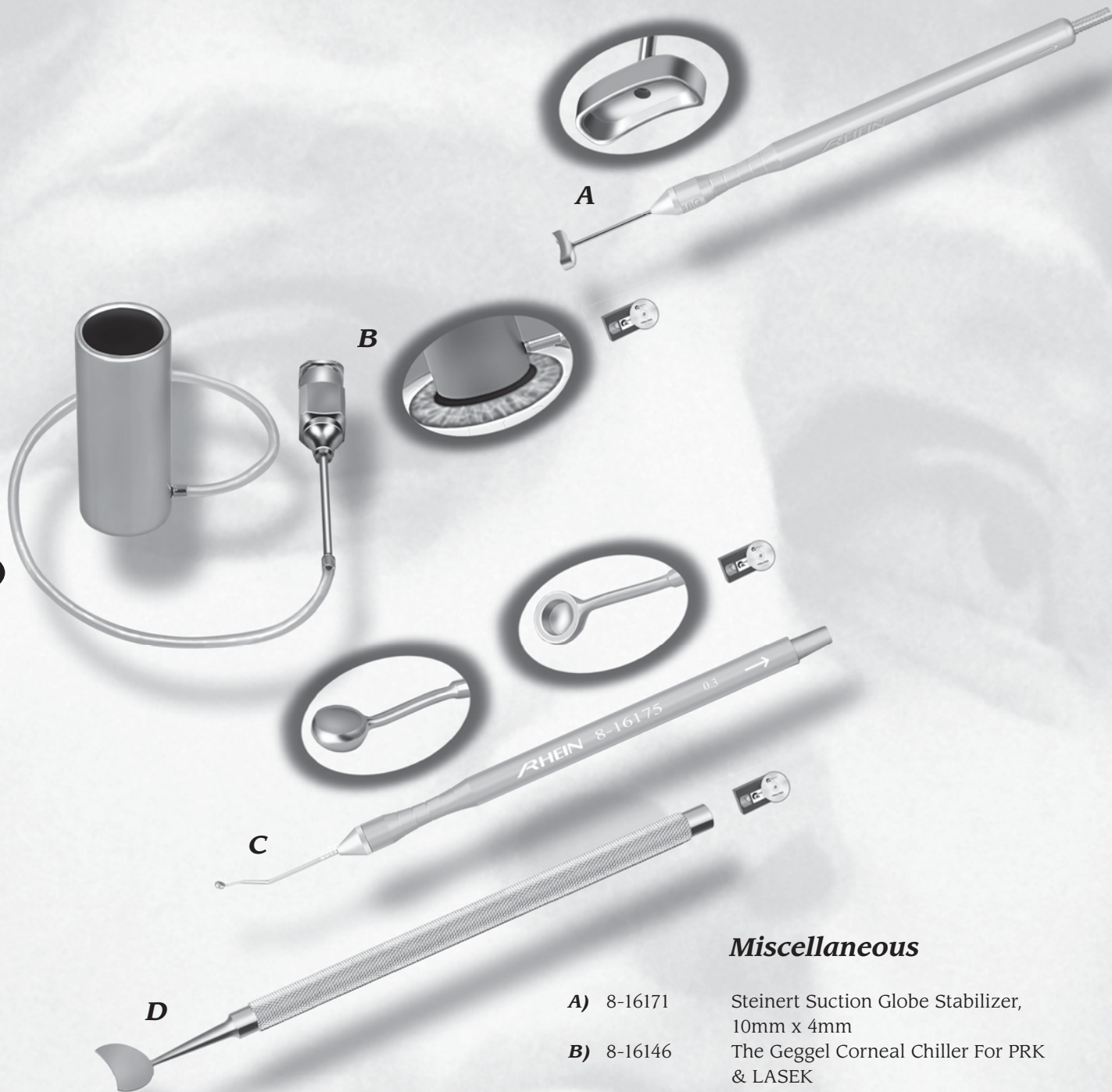

Miscellaneous

- A) 8-16171 Steinert Suction Globe Stabilizer, 10mm x 4mm
- B) 8-16146 The Geggel Corneal Chiller For PRK & LASEK
- C) 8-16175 Brown ICL Suction Manipulator
- D) 8-16165 Harden LASIK Flap Epithelial Removal Platform



ELEVATING THE QUALITY OF CARE IN OPHTHALMOLOGY
800-637-4346



PRK, LASIK & INTRALASE INSTRUMENTS

Retreatment Hooks

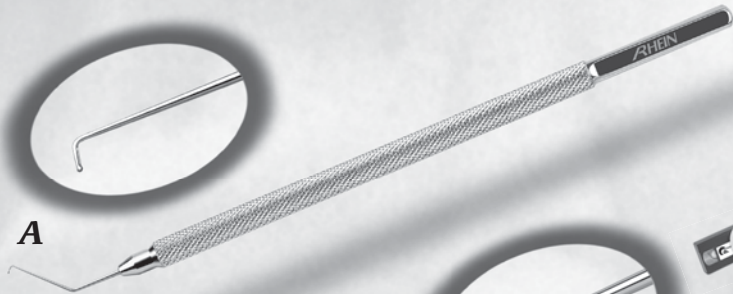

A

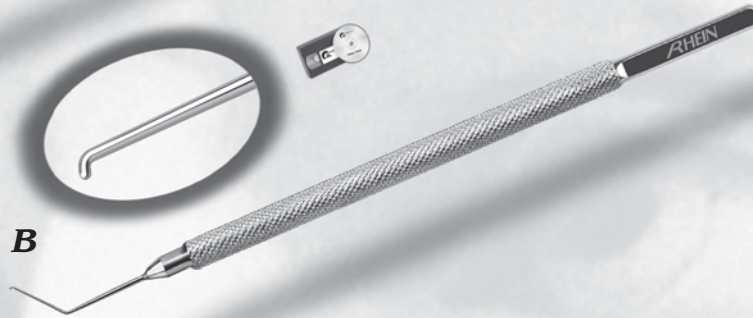

B

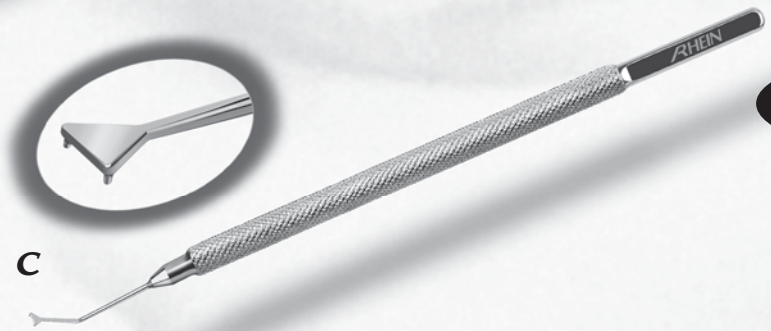

C

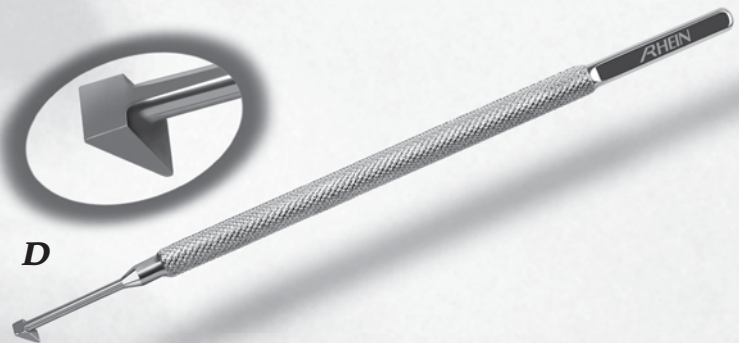

D

Retreatment Hooks

- A)** 8-16158 Behler LASIK Retreatment Hook
- B)** 8-16166 Trujillo LASIK Enhancement Hook
- C)** 8-16167 Trujillo LASIK Enhancement Rake
- D)** 8-16168 Trujillo LASIK Enhancement Wedge

22.07



ELEVATING THE QUALITY



1-800-263-3557

PRK, LASIK & INTRALASE INSTRUMENTS

Spatulas

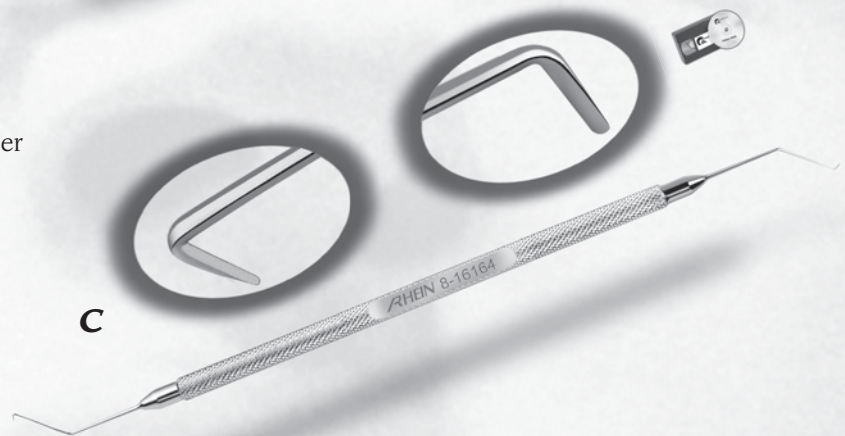
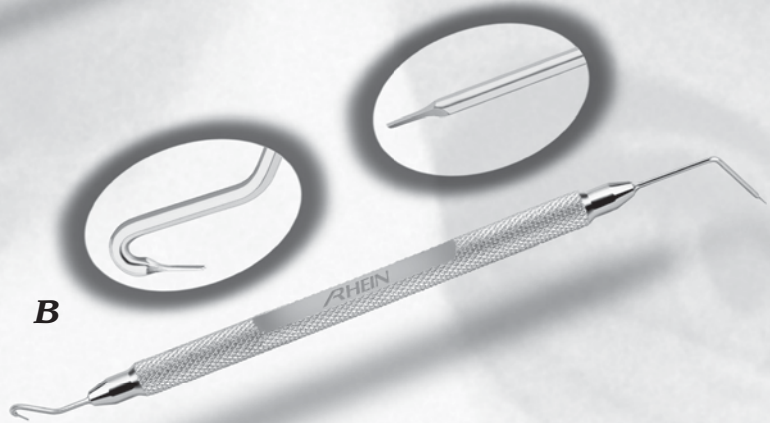
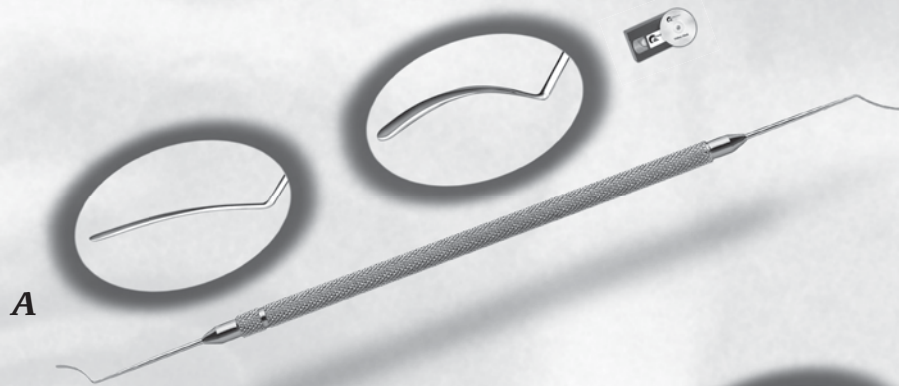

22.08

Spatulas

- A) 8-16142 Banaji Double-Ended LASIK Spatula
- B) 8-16169 Castillejos LASIK Retreatment Spatula
- C) 8-16164 Hardten Double Ended LASIK Flap Lifter & Spatula



ELEVATING THE QUALITY OF CARE IN OPHTHALMOLOGY
800-637-4346



PRK, LASIK & INTRALASE INSTRUMENTS

Spatulas

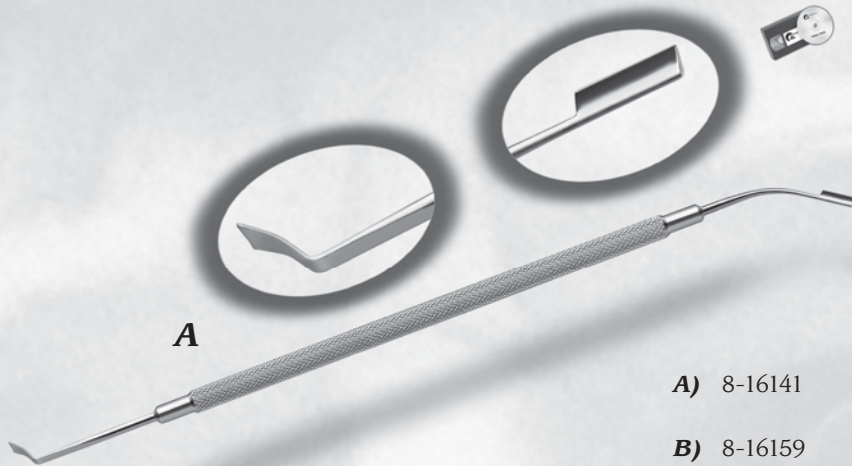

A

- A)** 8-16141 Rhein LASIK Flap Elevator & Stromal Spatula
- B)** 8-16159 Seibel Double-Ended LASIK Flap Lifter & Spatula
- C)** 8-16148 Steinert Double-Ended LASIK Spatula

Spatulas

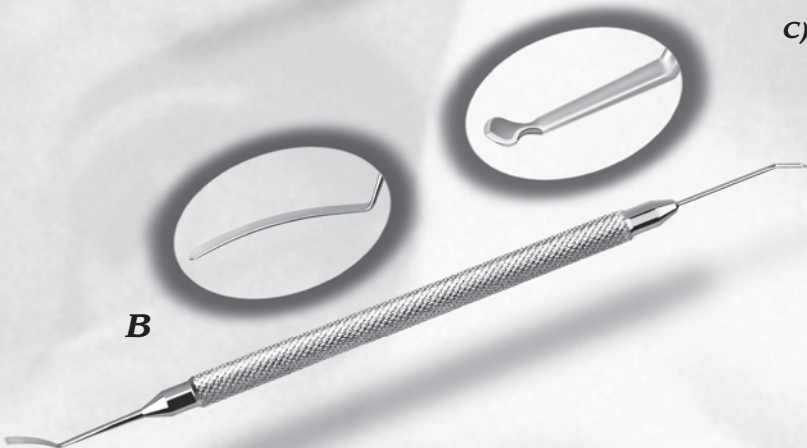

B

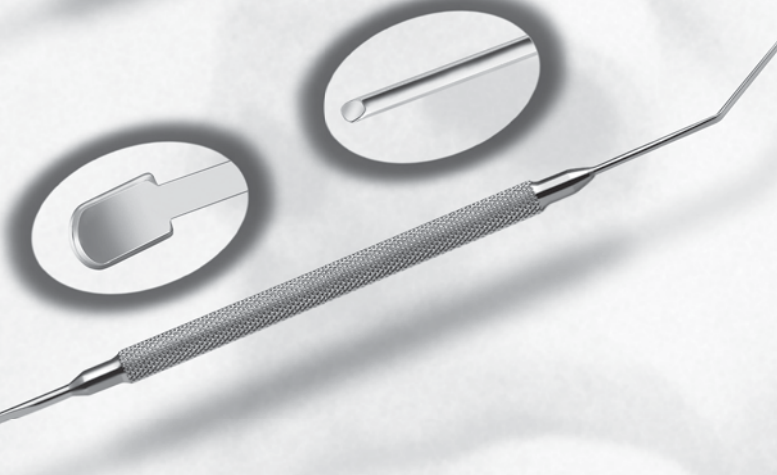

C

22.09



ELEVATING THE QUALITY



1-800-263-3557



RETRACTORS

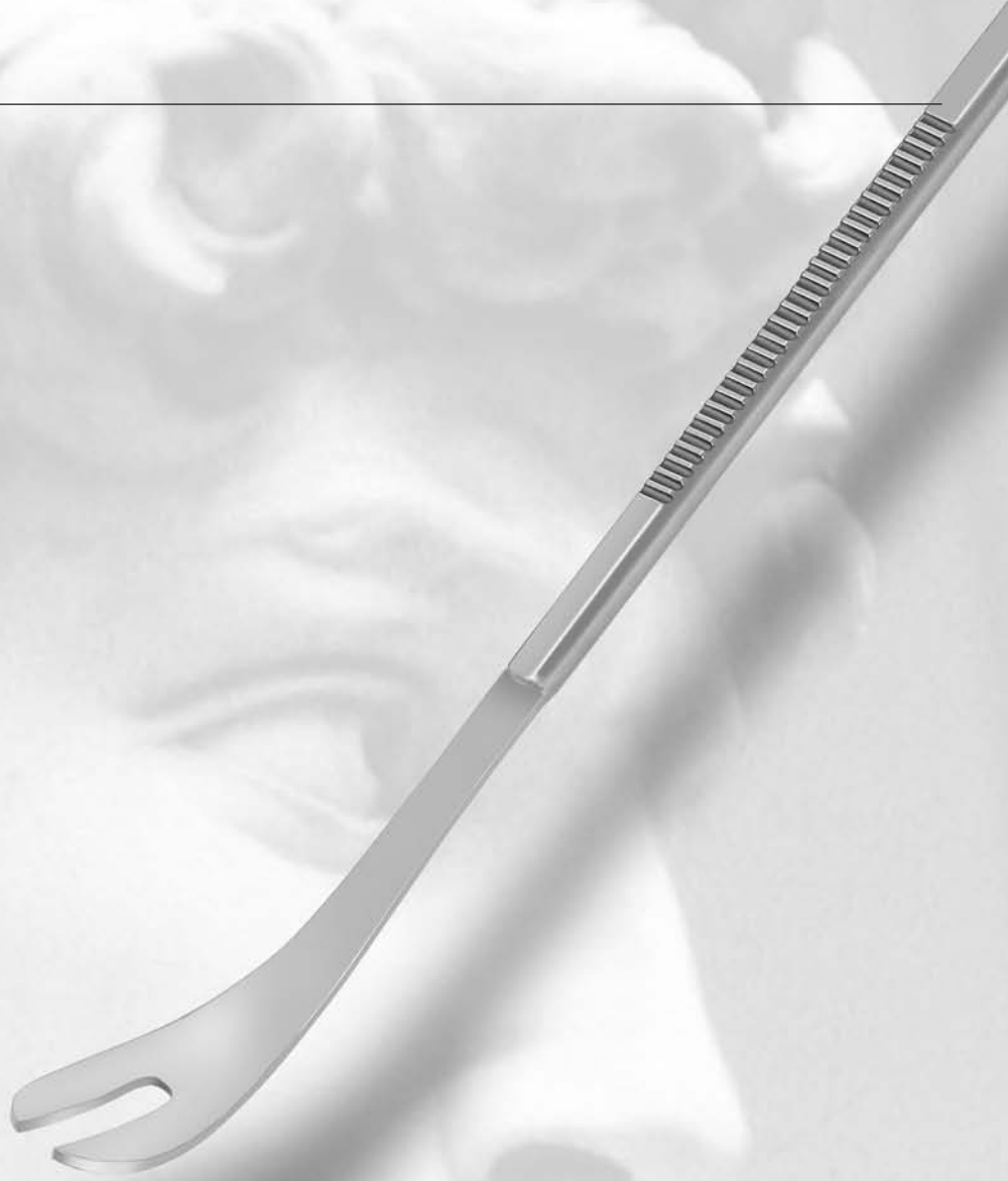

23.00



ELEVATING THE QUALITY OF CARE IN OPHTHALMOLOGY
800-637-4346



1-800-263-3557

RETRACTORS

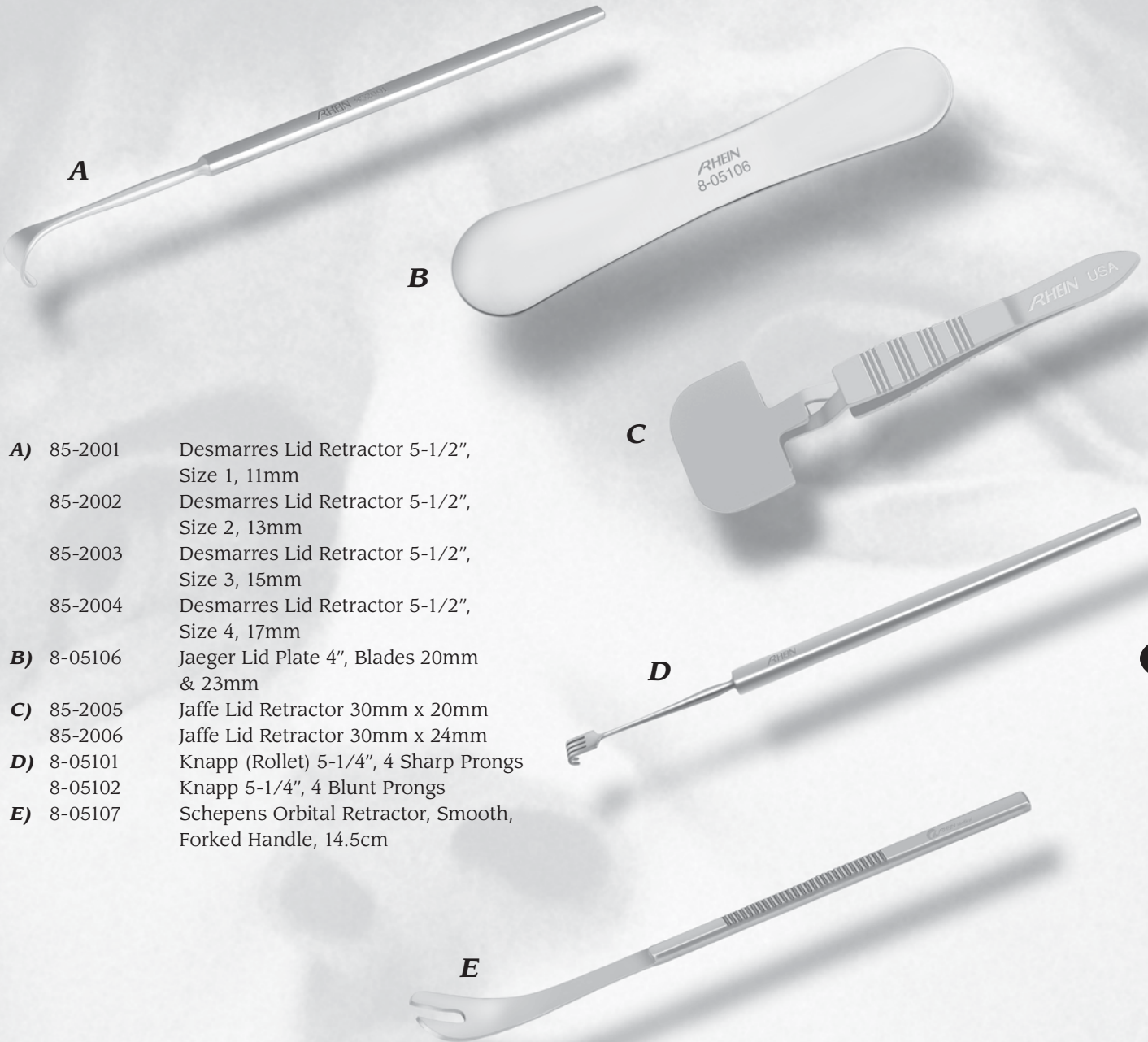

- A)** 85-2001 Desmarres Lid Retractor 5-1/2",
Size 1, 11mm
- 85-2002 Desmarres Lid Retractor 5-1/2",
Size 2, 13mm
- 85-2003 Desmarres Lid Retractor 5-1/2",
Size 3, 15mm
- 85-2004 Desmarres Lid Retractor 5-1/2",
Size 4, 17mm
- B)** 8-05106 Jaeger Lid Plate 4", Blades 20mm
& 23mm
- C)** 85-2005 Jaffe Lid Retractor 30mm x 20mm
- 85-2006 Jaffe Lid Retractor 30mm x 24mm
- D)** 8-05101 Knapp (Rollet) 5-1/4", 4 Sharp Prongs
- 8-05102 Knapp 5-1/4", 4 Blunt Prongs
- E)** 8-05107 Schepens Orbital Retractor, Smooth,
Forked Handle, 14.5cm

23.01



ELEVATING THE QUALITY



1-800-263-3557



RK, AK, LRI, CK & CORNEAL MARKERS

- **Radial Markers**-24.01
- **AK Markers**-24.03
- **LRI Markers**-24.05
- **CK Markers**-24.09
- **Optical Zone Markers**-24.10
- **PKP Marker**-24.10



24.00



ELEVATING THE QUALITY OF CARE IN OPHTHALMOLOGY
800-637-4346



1-800-263-3557

RK, AK, LRI, CK & CORNEAL MARKERS

Radial Markers

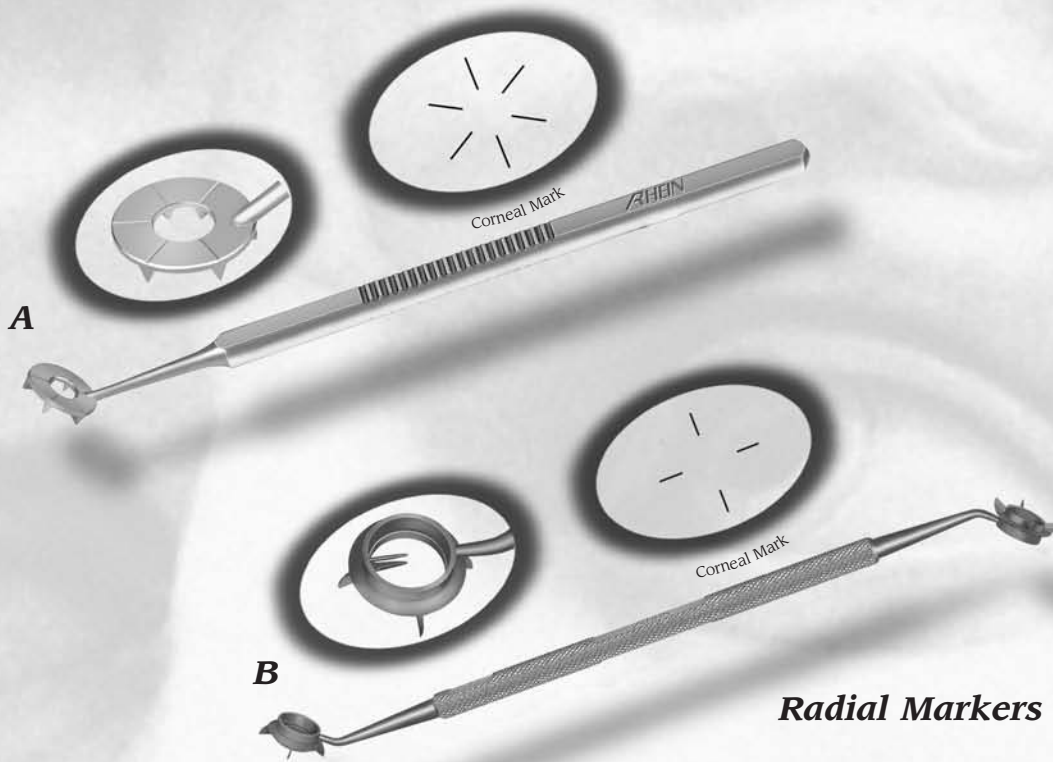

Radial Markers

- A)** 8-15215 Bores Radial Marker, 6 Blades
- 8-15216 Bores Radial Marker, 8 Blades
- B)** 05-8120 4-Blade RK Marker Double End, 7.25&7.50mm-Titanium
- 05-8102 4-Blade RK Marker Double End, 2.75&3.00mm-Titanium
- 05-8104 4-Blade RK Marker Double End, 3.25&3.50mm-Titanium
- 05-8106 4-Blade RK Marker Double End, 3.75&4.00mm-Titanium
- 05-8108 4-Blade RK Marker Double End, 4.25&4.50mm-Titanium
- 05-8110 4-Blade RK Marker Double End, 4.75&5.00mm-Titanium
- 05-8112 4-Blade RK Marker Double End, 5.25&5.50mm-Titanium
- 05-8114 4-Blade RK Marker Double End, 5.75&6.00mm-Titanium
- 05-8116 4-Blade RK Marker Double End, 6.25&6.50mm-Titanium
- 05-8118 4-Blade RK Marker Double End, 6.75&7.00mm-Titanium
- 05-8122 4-Blade RK Marker Double End, 7.75&8.00mm-Titanium

24.01



ELEVATING THE QUALITY OF CARE IN OPHTHALMOLOGY
800-637-4346



1-800-263-3557

RK, AK, LRI, CK & CORNEAL MARKERS

Radial Markers

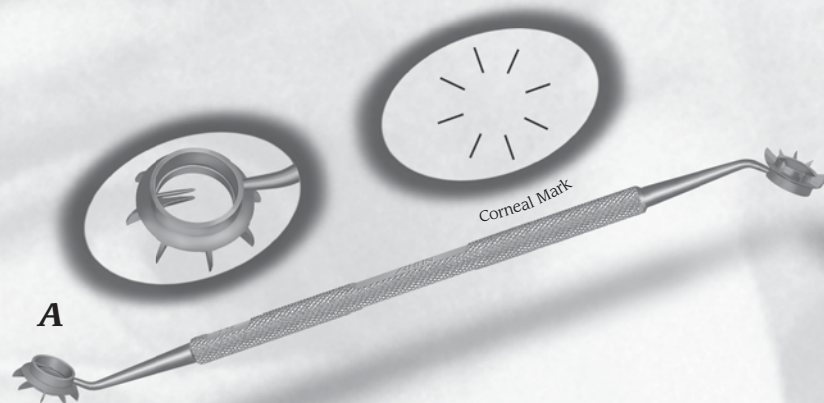

Radial Markers

- A) 05-8202 8-Blade RK Marker Double End, 2.75&3.00mm-Titanium
- 05-8204 8-Blade RK Marker Double End, 3.25&3.50mm-Titanium
- 05-8206 8-Blade RK Marker Double End, 3.75&4.00mm-Titanium
- 05-8208 8-Blade RK Marker Double End, 4.25&4.50mm-Titanium
- 05-8210 8-Blade RK Marker Double End, 4.75&5.00mm-Titanium
- 05-8212 8-Blade RK Marker Double End, 5.25&5.50mm-Titanium
- 05-8214 8-Blade RK Marker Double End, 5.75&6.00mm-Titanium
- 05-8216 8-Blade RK Marker Double End, 6.25&6.50mm-Titanium
- 05-8218 8-Blade RK Marker Double End, 6.75&7.00mm-Titanium
- 05-8220 8-Blade RK Marker Double End, 7.25&7.50mm-Titanium
- 05-8222 8-Blade RK Marker Double End, 7.75&8.00mm-Titanium

24.02



RK, AK, LRI, CK & CORNEAL MARKERS

AK Markers

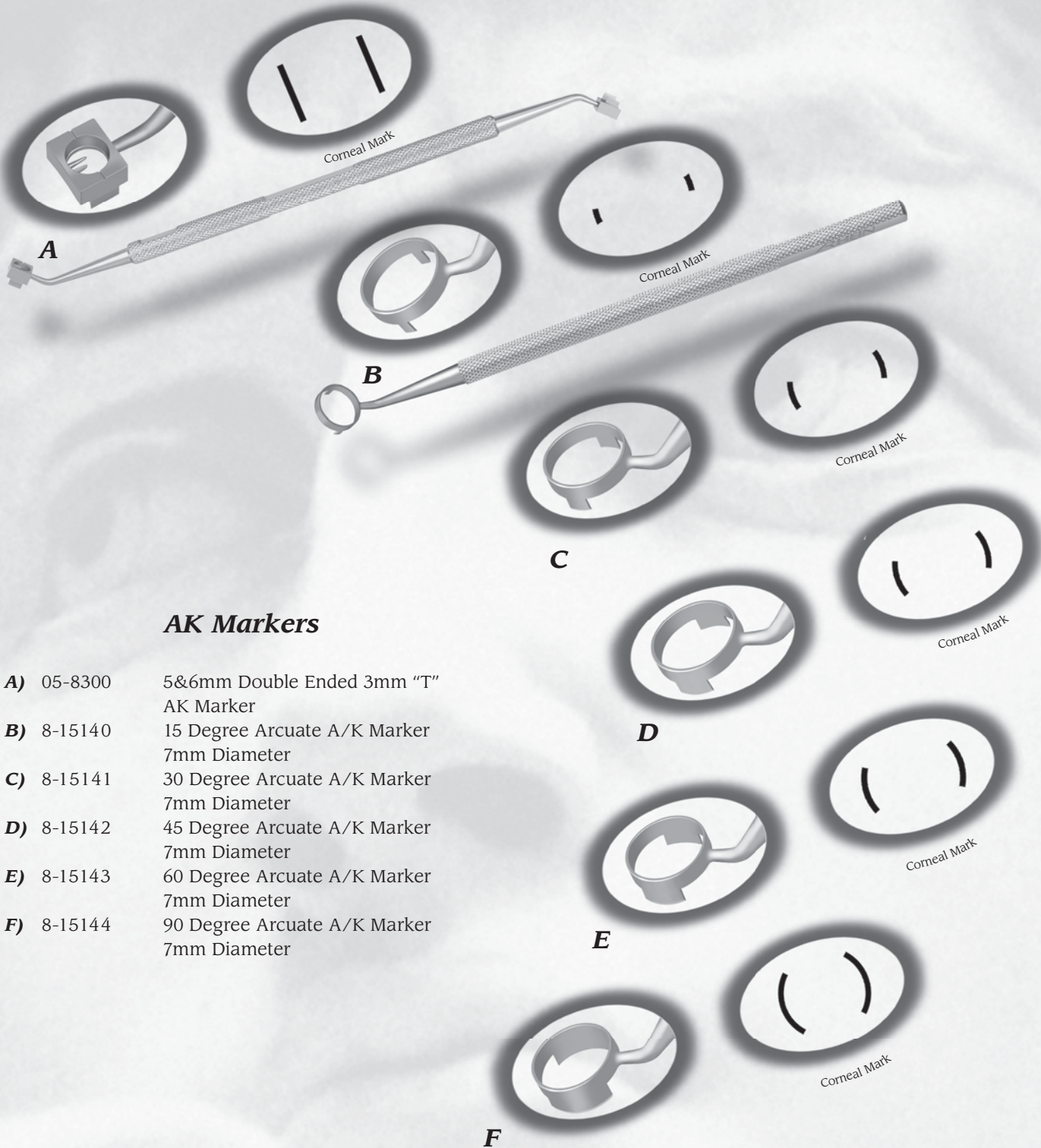

AK Markers

- A)** 05-8300 5&6mm Double Ended 3mm "T" AK Marker
- B)** 8-15140 15 Degree Arcuate A/K Marker 7mm Diameter
- C)** 8-15141 30 Degree Arcuate A/K Marker 7mm Diameter
- D)** 8-15142 45 Degree Arcuate A/K Marker 7mm Diameter
- E)** 8-15143 60 Degree Arcuate A/K Marker 7mm Diameter
- F)** 8-15144 90 Degree Arcuate A/K Marker 7mm Diameter

24.03



ELEVATING THE QU



1-800-263-3557



RK, AK, LRI, CK & CORNEAL MARKERS

AK Markers

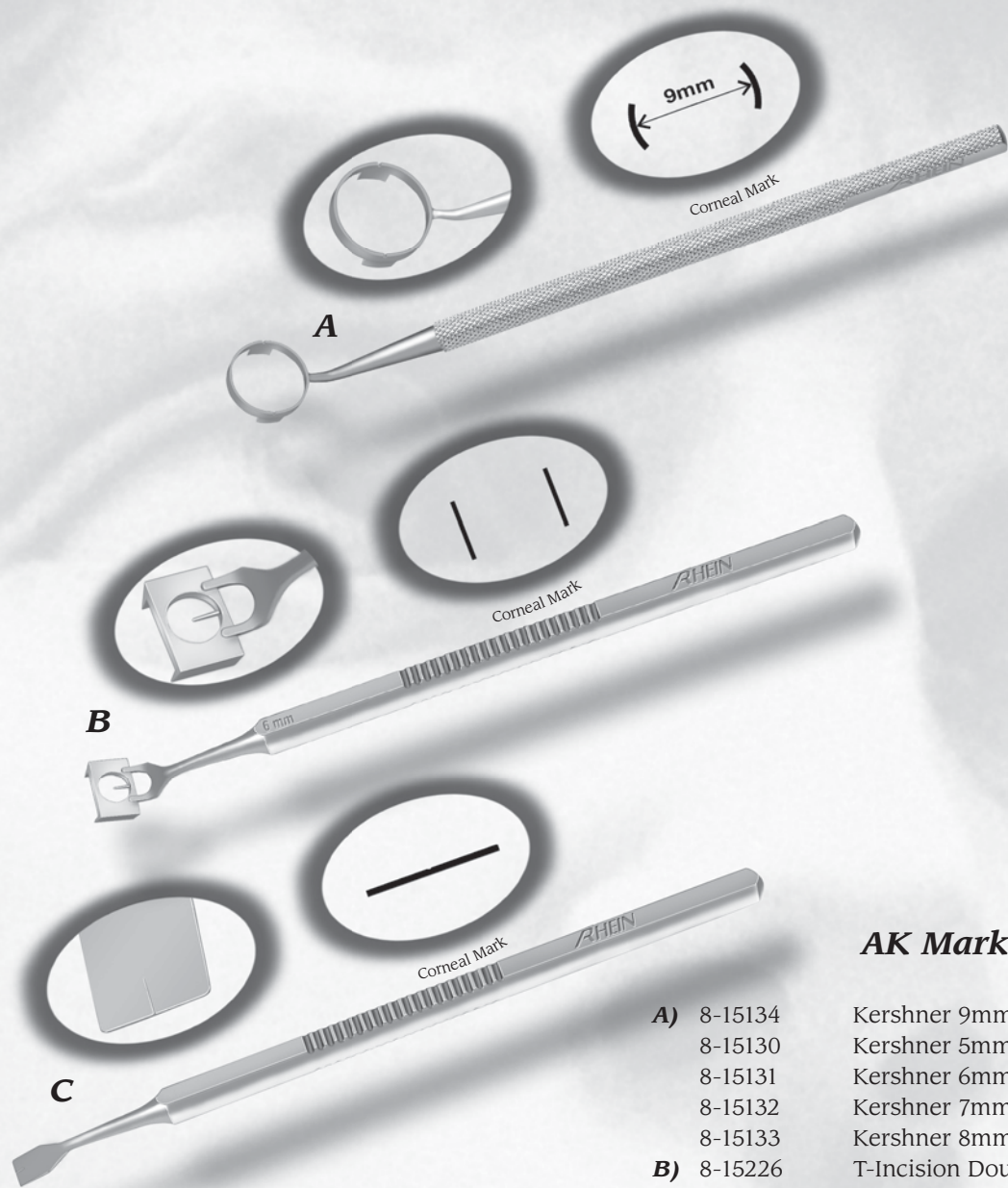

24.04

AK Markers

- | | | |
|-----------|---------|--|
| A) | 8-15134 | Kershner 9mm Arcuate A/K Marker |
| | 8-15130 | Kershner 5mm Arcuate A/K Marker |
| | 8-15131 | Kershner 6mm Arcuate A/K Marker |
| | 8-15132 | Kershner 7mm Arcuate A/K Marker |
| | 8-15133 | Kershner 8mm Arcuate A/K Marker |
| B) | 8-15226 | T-Incision Double Marker, 5mm Blades, 6mm Spread |
| | 8-15225 | T-Incision Double Marker, 5mm Blades, 5mm Spread |
| | 8-15227 | T-Incision Double Marker, 5mm Blades, 7mm Spread |
| | 8-15228 | T-Incision Double Marker, 5mm Blades, 8mm Spread |
| C) | 8-15246 | T-Incision Single AK Marker, 5.0mm Wide |
| | 8-15240 | T-Incision Single AK Marker, 2.0mm Wide |
| | 8-15241 | T-Incision Single AK Marker, 2.5mm Wide |
| | 8-15242 | T-Incision Single AK Marker, 3.0mm Wide |
| | 8-15243 | T-Incision Single AK Marker, 3.5mm Wide |
| | 8-15244 | T-Incision Single AK Marker, 4.0mm Wide |
| | 8-15245 | T-Incision Single AK Marker, 4.5mm Wide |



ELEVATING THE QUALITY OF CARE IN OPHTHALMOLOGY
800-637-4346



RK, AK, LRI, CK & CORNEAL MARKERS

LRI Markers

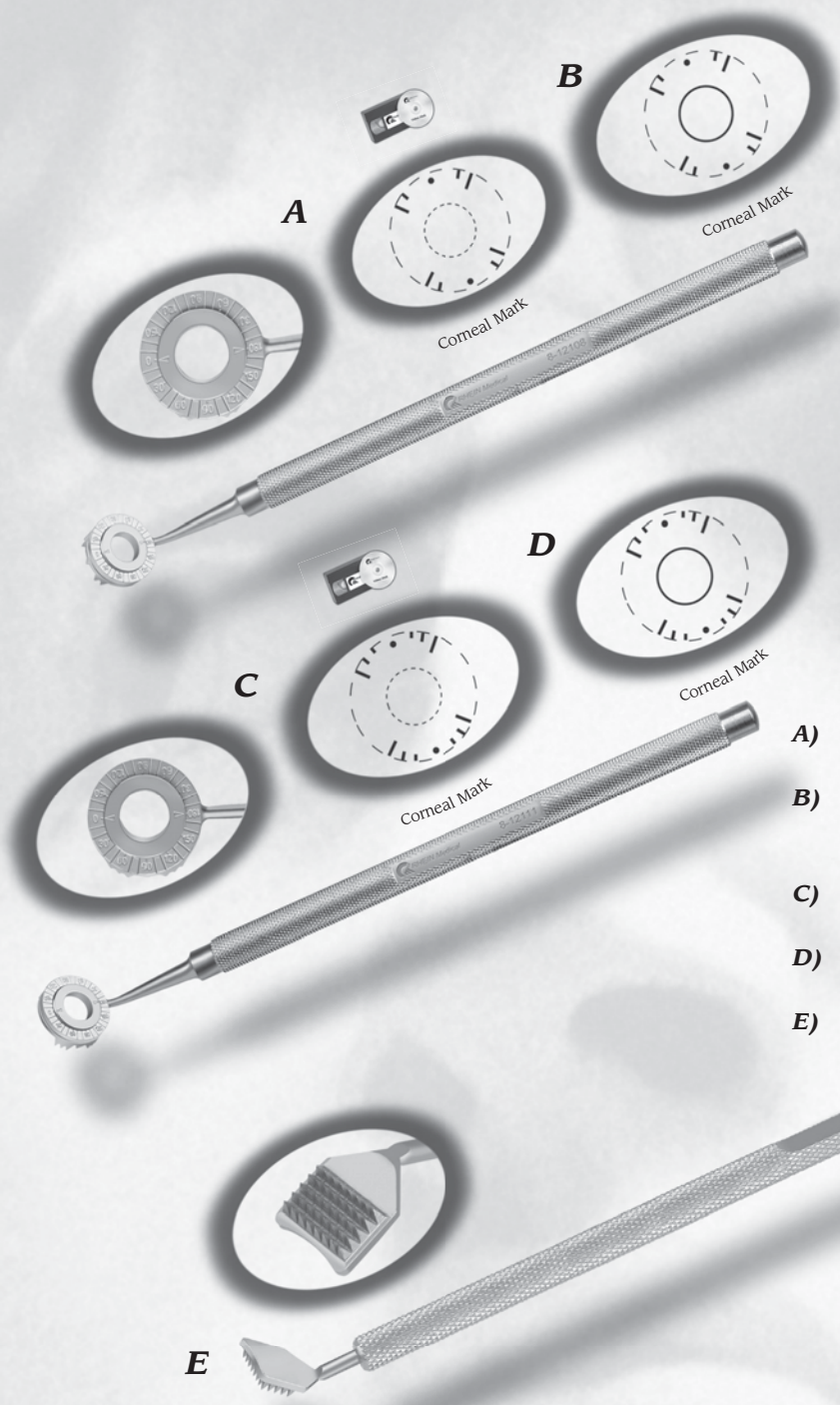

LRI Markers

- A)** 8-12108 Dell Astigmatism Marker, 6mm & 8mm Cord Length (Gills)
- B)** 8-12108-5 Dell Astigmatism Marker, 6mm & 8mm Cord Length (Gills) w/5mm Circle
- C)** 8-12111 Dell Astigmatism Marker, 40, 60, & 80 Degrees (Nichamin)
- D)** 8-12111-5 Dell Astigmatism Marker, 40, 60, & 80 Degrees (Nichamin) w/5mm Circle
- E)** 8-12106 Fine Scleral Marker

24.05



ELEVATING THE QU



RK, AK, LRI, CK & CORNEAL MARKERS

LRI Markers

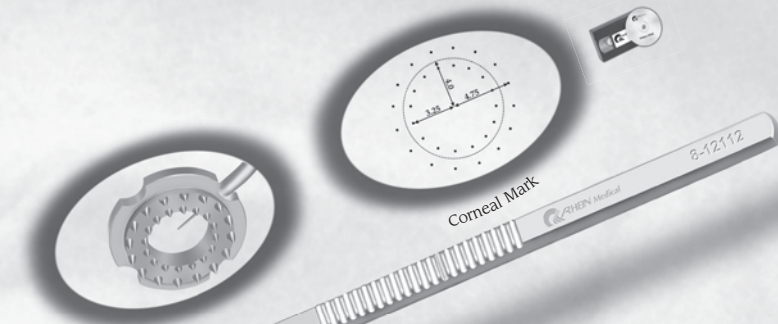

A

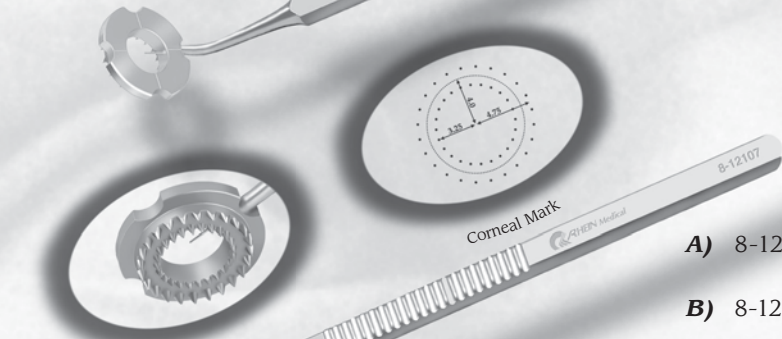

B



C

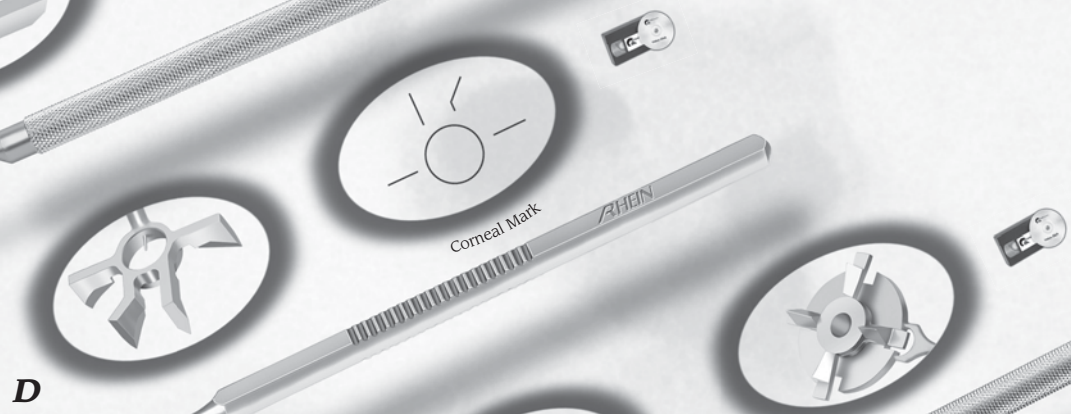

D

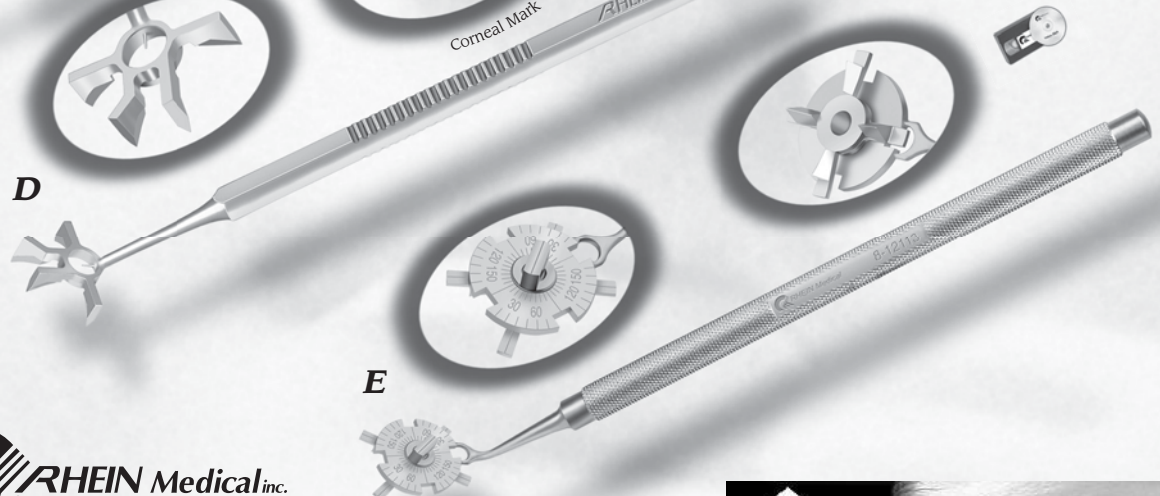

E

LRI Markers

- A)** 8-12112 Geggel Corneal Transplant Marker, 16 Bite Running Suture
- B)** 8-12107 Geggel Corneal Transplant Marker, 24 Bite Running Suture
- C)** 8-12109 Glaucoma Marker 5mm x 5mm
- D)** 8-12114 Maldonado UAF LASIK Marker
- E)** 8-12113 Ruminson Astigmatic Gauge & Marker, 7mm ID & 14mm OD

24.06



ELEVATING THE QUALITY OF CARE IN OPHTHALMOLOGY
800-637-4346



1-800-263-3557

RK, AK, LRI, CK & CORNEAL MARKERS

LRI Markers



LRI Markers

- A)** 8-15201 Bores Axis Marker
- B)** 8-15200 Mendez Degree Gauge
- C)** 8-15253 Brown LRI Guide (ID: 11.5mm, OD: 14.5mm, 10 Degree Marks)
- D)** 8-15145 Kershner LRI Marker, 8mm ID, 10mm OD, Opposing Radials 15 Degrees Apart
- E)** 8-15254 Rousseau Dual-Tip Slit Lamp Mounted Axis Marker

24.07



RK, AK, LRI, CK & CORNEAL MARKERS

LRI Markers

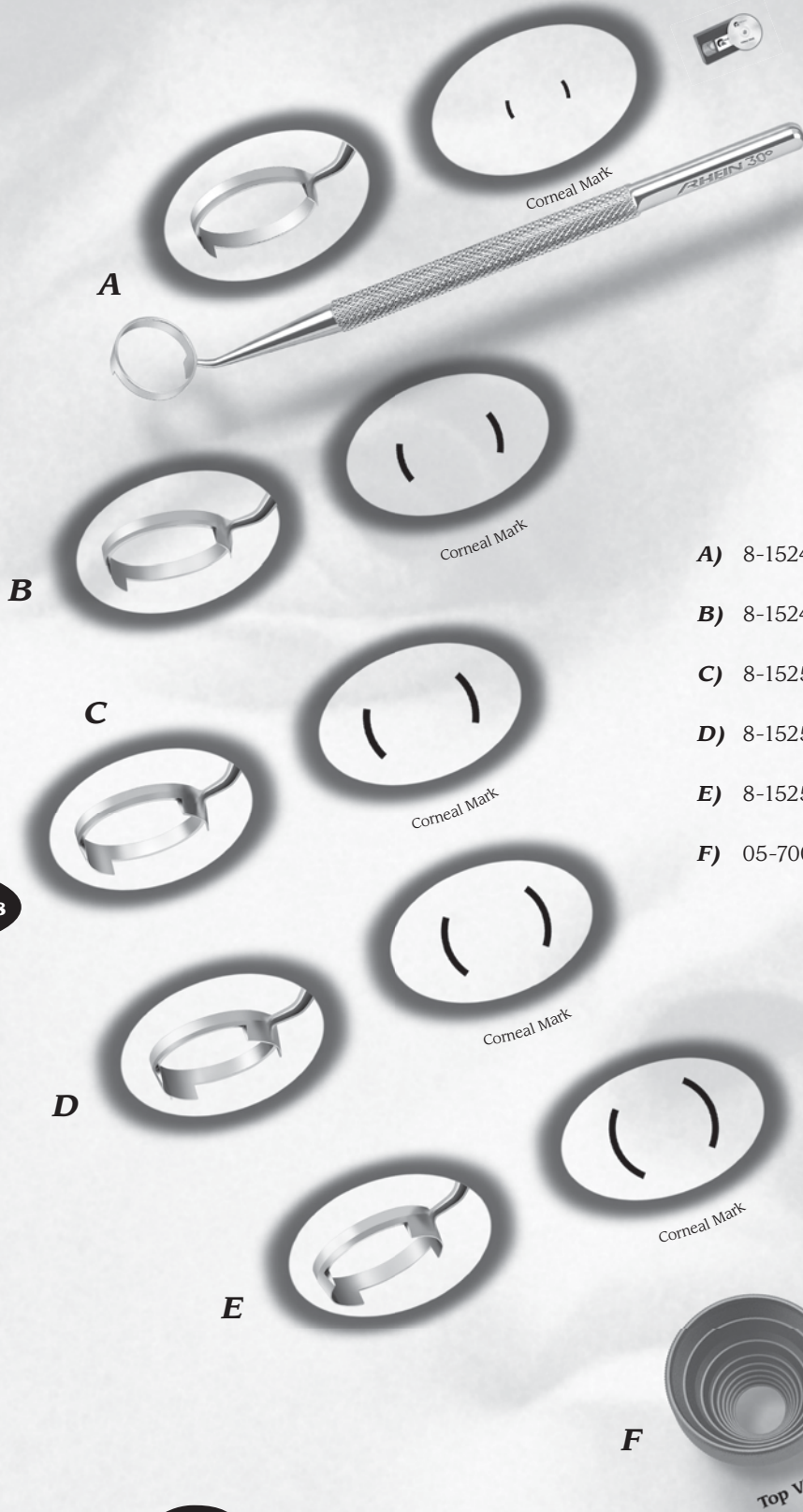

LRI Markers

- A)** 8-15248 Kershner-Nichamin 30 Degree 10.0mm LRI Marker
- B)** 8-15249 Kershner-Nichamin 45 Degree 10.0mm LRI Marker
- C)** 8-15250 Kershner-Nichamin 60 Degree 10.0mm LRI Marker
- D)** 8-15251 Kershner-Nichamin 75 Degree 10.0mm LRI Marker
- E)** 8-15252 Kershner-Nichamin 90 Degree 10.0mm LRI Marker
- F)** 05-7005 Maloney Astigmatism Keratometer-Titanium

24.08



ELEVATING THE QUALITY OF CARE IN OPHTHALMOLOGY
800-637-4346



1-800-263-3557

RK, AK, LRI, CK & CORNEAL MARKERS

CK Markers

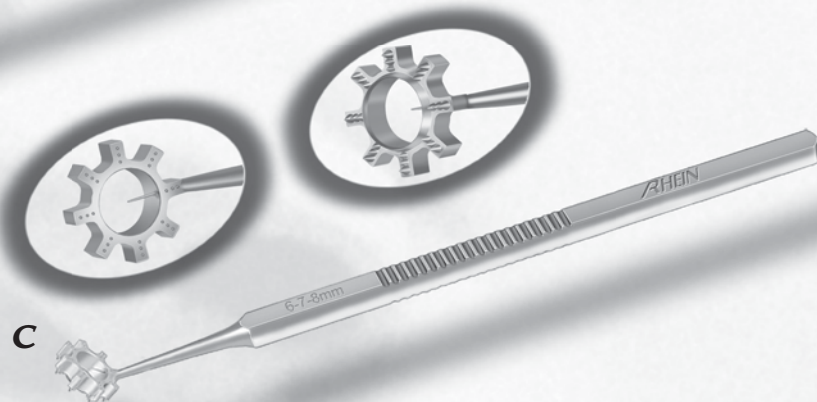
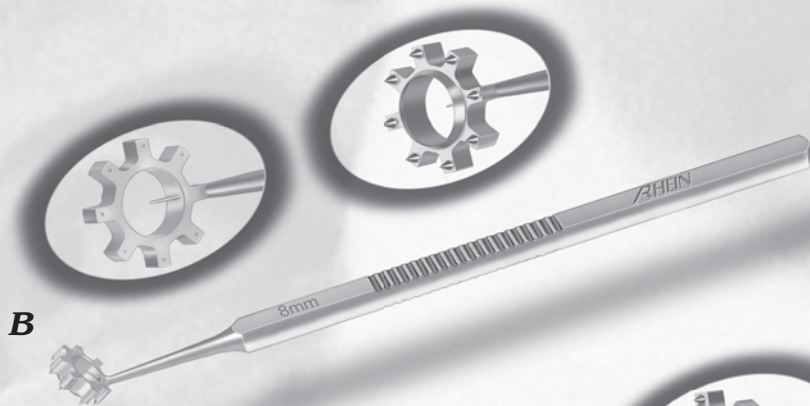
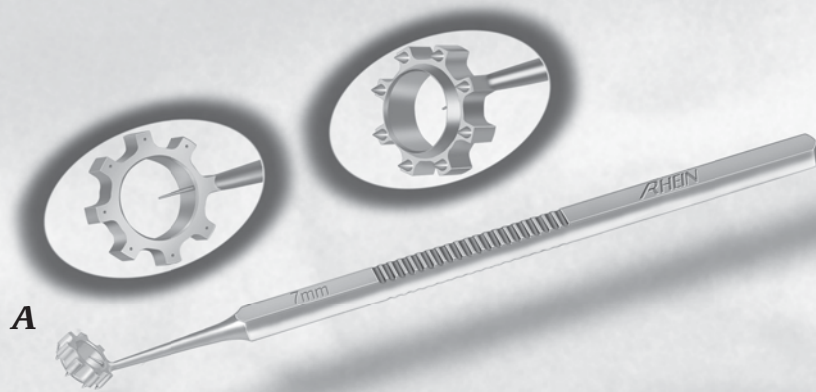

CK Markers

- A)** 8-15256: CK Marker, 7mm OD, w/8 Equal Points, 5mm Inner Circle, w/Center Pointer
- B)** 8-15257: CK Marker, 8mm OD, w/8 Equal Points, 5mm Inner Circle, w/Center Pointer
- C)** 8-15258: CK Marker, 6/7/8mm OD, w/24 Equal Points, 5mm Inner Circle, w/Center Pointer

24.09



ELEVATING THE QU



1-800-263-3557

RK, AK, LRI, CK & CORNEAL MARKERS

Optical Zone Markers and PKP Marker

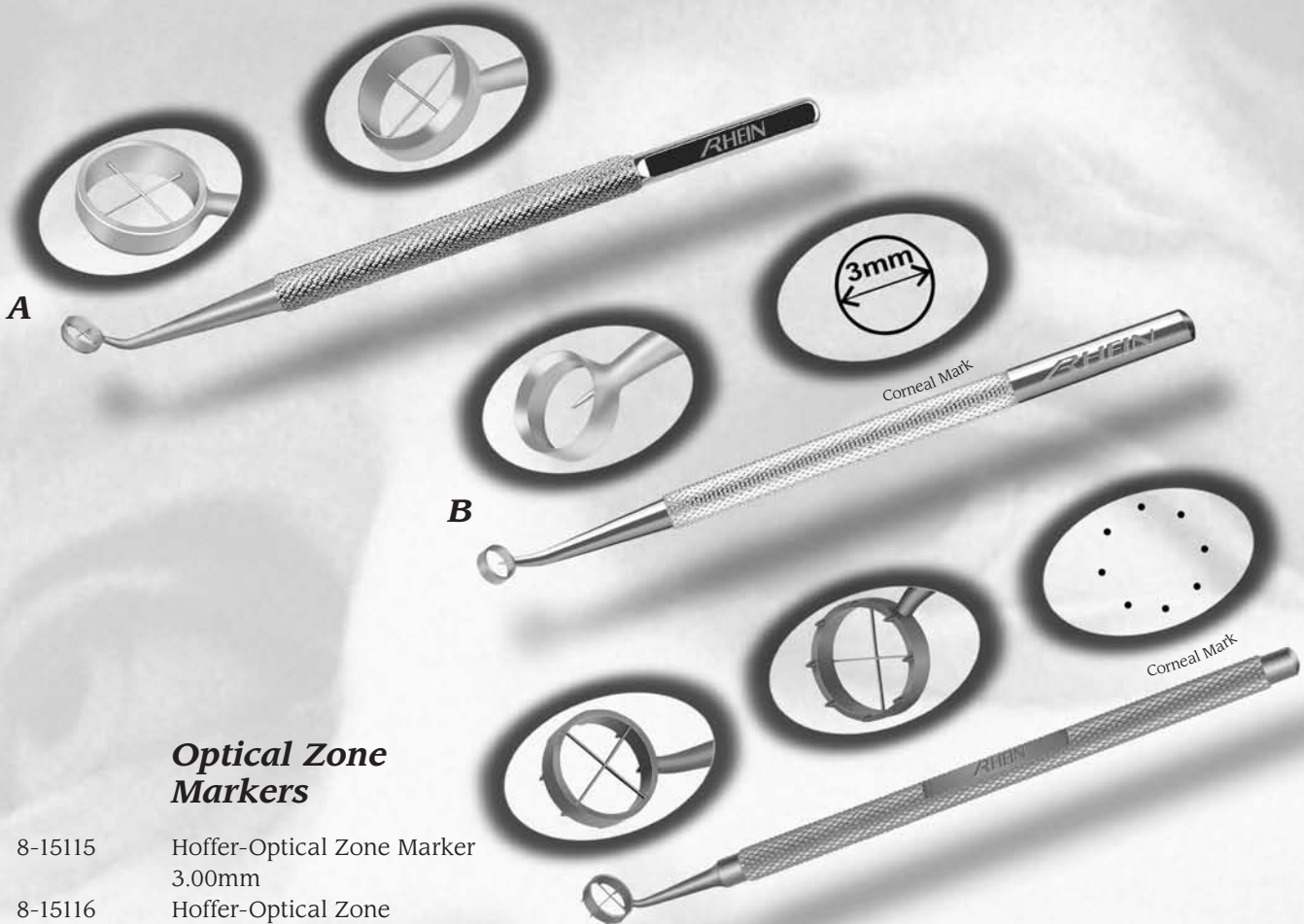

Optical Zone Markers

- A)** 8-15115 Hoffer-Optical Zone Marker 3.00mm
 8-15116 Hoffer-Optical Zone Marker 3.25mm
 8-15117 Hoffer-Optical Zone Marker 3.50mm
 8-15118 Hoffer-Optical Zone Marker 3.75mm
 8-15119 Hoffer-Optical Zone Marker 4.00mm
 8-15120 Hoffer-Optical Zone Marker 4.25mm
 8-15121 Hoffer-Optical Zone Marker 4.50mm
 8-15122 Hoffer-Optical Zone Marker 4.75mm
 8-15123 Hoffer-Optical Zone Marker 5.00mm
 8-15124 Hoffer-Optical Zone Marker 5.50mm
 8-15125 Hoffer-Optical Zone Marker 6.00mm
 8-15126 Hoffer-Optical Zone Marker 7.00mm
 8-15127 Hoffer-Optical Zone Marker 8.00mm
 8-15128 Hoffer-Optical Zone Marker 11.00mm

- B)** 8-15100 Thornton-Optical Zone Marker 3.00mm
 8-15101 Thornton-Optical Zone Marker 3.25mm
 8-15102 Thornton-Optical Zone Marker 3.50mm
 8-15103 Thornton-Optical Zone Marker 3.75mm
 8-15104 Thornton-Optical Zone Marker 4.00mm
 8-15105 Thornton-Optical Zone Marker 4.25mm
 8-15106 Thornton-Optical Zone Marker 4.50mm
 8-15107 Thornton-Optical Zone Marker 4.75mm
 8-15108 Thornton-Optical Zone Marker 5.00mm

PKP Marker

- C)** 05-7006 PKP 8.0mm Marker w/8 Equal Points-Titanium

24.10



ELEVATING THE QUALITY OF CARE IN OPHTHALMOLOGY
 800-637-4346



1-800-263-3557

RK, AK, LRI, CK & CORNEAL MARKERS

Notes

24.11



ELEVATING THE QUALITY



acor

1-800-263-3557



SCISSORS

- **Capsulotomy Scissors**-25.01
- **Corneal Scissors**-25.02
- **Iris Scissors**-25.04
- **Miscellaneous Scissors**-25.05
- **Stitch Scissors**-25.06
- **Tenotomy Scissors**-25.07



Scissors:

We offer our scissors in only stainless steel. We have found that the cutting ability of titanium degrades quicker than stainless steel.

25.00



ELEVATING THE QUALITY OF CARE IN OPHTHALMOLOGY
800-637-4346



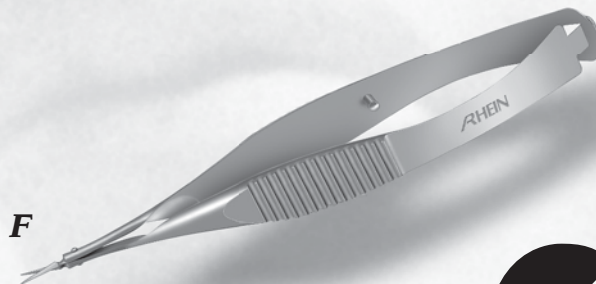
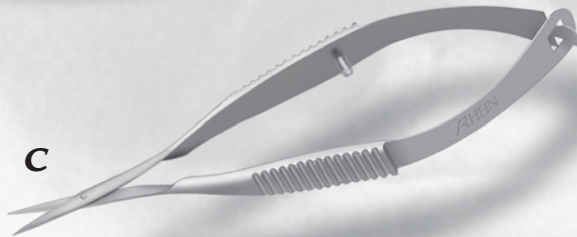
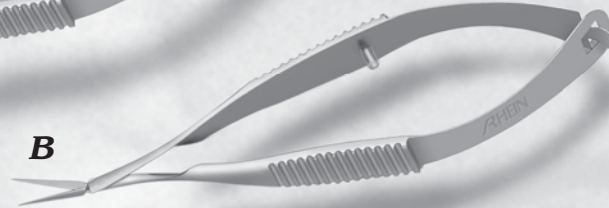
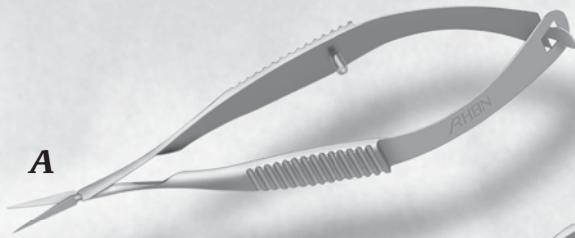

Capsulotomy Scissors

- A)** 8-03503 Gills/Vannas Scissors, 10mm, Straight
- 8-03502 Gills/Vannas Scissors, 7mm, Curved
- 8-03504 Gills/Vannas Scissors, 10mm, Curved
- 8-03501 Gills/Vannas X-Thin 7mm Sharp Blades, Straight
- B)** 8-03507 Gills/Welsh Vannas Scissors, Angled, 11mm Blades
- 8-03505 Stern/Gills Scissors, 10mm, Angled
- 8-03506 Stern/Gills Scissors, 7mm, Angled
- C)** 8-03511 McPherson/Vannas 3-1/4", Straight Sharp Points
- 8-03512 McPherson/Vannas 3-1/4", Curved Sharp Points
- D)** 8-03510 Vannas 3-1/4", Angled On Flat, Sharp Points
- E)** 8-03509 Vannas 3-1/4", Angled To Side, Sharp Points
- F)** 8-03508 Vannas Scissors 3-1/4", Sharp, Delicate 5mm Blades

25.01



ELEVATING THE QUALITY



1-800-263-3557



SCISSORS

Corneal Scissors

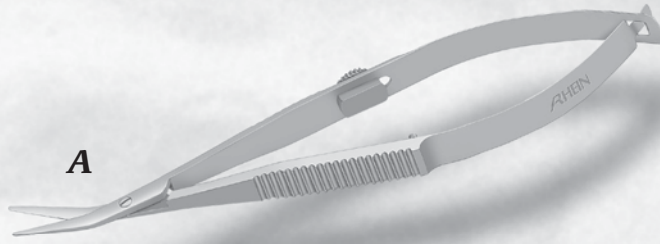

A

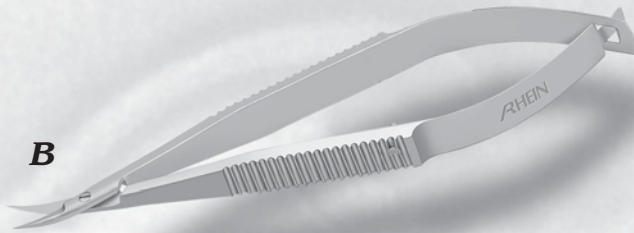

B

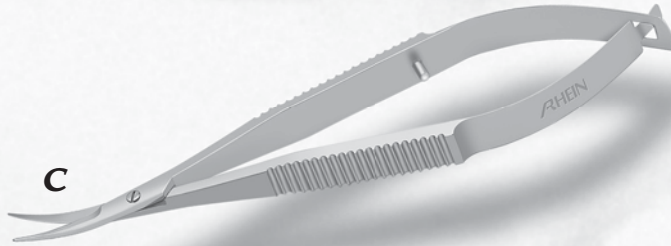

C

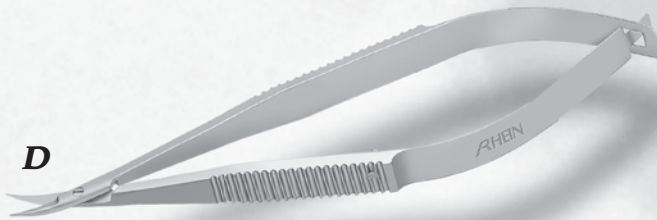

D

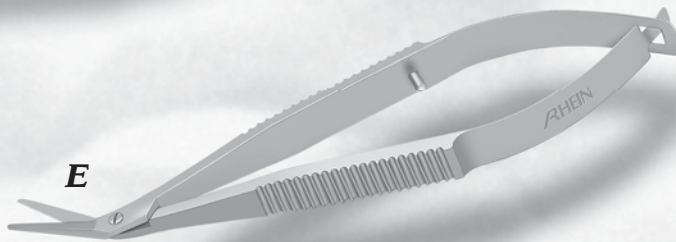

E

Corneal Scissors

- A)** 8-03236 Barraquer Scissors, Angled Small Blades, Right w/Lock
- 8-03237 Barraquer Scissors, Angled Small Blades, Left w/Lock
- B)** 8-03207 Castroviejo Corneal Section, Curved, Blunt Tips, Medium
- C)** 8-03208 Castroviejo Corneal Section, Curved, Blunt Tips, Large
- D)** 8-03209 Castroviejo Corneal, Curved Blunt Tips, Small
- E)** 8-03211 Castroviejo Keratoplasty Scissors, Blunt Points
- 8-03210 Castroviejo Keratoplasty Scissors, Sharp Points

25.02



ELEVATING THE QUALITY OF CARE IN OPHTHALMOLOGY
800-637-4346



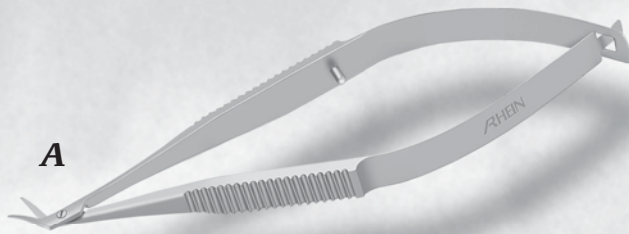

A

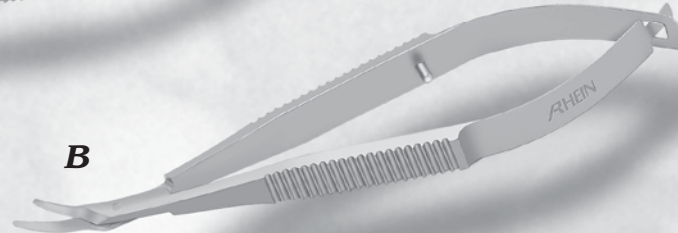

B

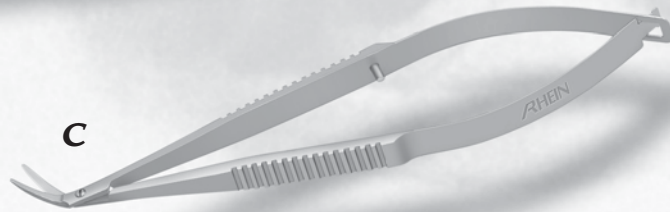

C

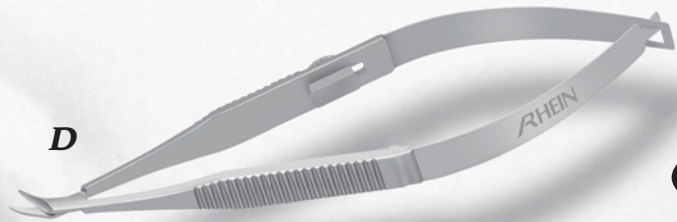

D

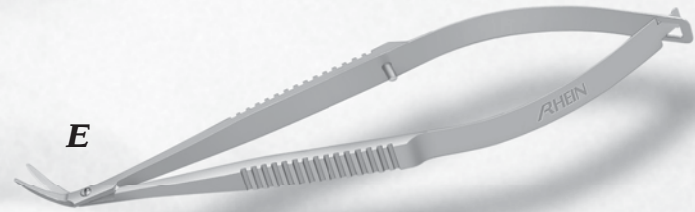

E

Corneal Scissors

- A)** 8-03202 Castroviejo Scissors Micro, Left
- 8-03201 Castroviejo Scissors Micro, Right
- B)** 8-03205 Castroviejo Scissors, Standard, Right
- 8-03206 Castroviejo Scissors, Standard, Left
- C)** 8-03243 Katzen Transplant Mini, Curved Medium Blades, Left
- 8-03242 Katzen Transplant Mini, Curved Medium Blades, Right
- D)** 8-03222 Troutman/Castroviejo Micro, Right w/Lock
- 8-03223 Troutman/Castroviejo Micro, Left w/Lock
- 8-03224 Troutman/Castroviejo Mini, Right w/Lock
- 8-03225 Troutman/Castroviejo Mini, Left w/Lock
- E)** 8-03230 Troutman/Katzen Transplant, Curved Small Blades, Right
- 8-03231 Troutman/Katzen Transplant, Curved Small Blades, Left

25.03



ELEVATING THE QUALITY



1-800-263-3557

SCISSORS

Iris Scissors

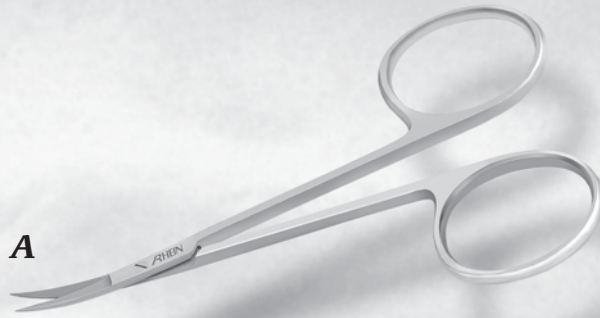

A

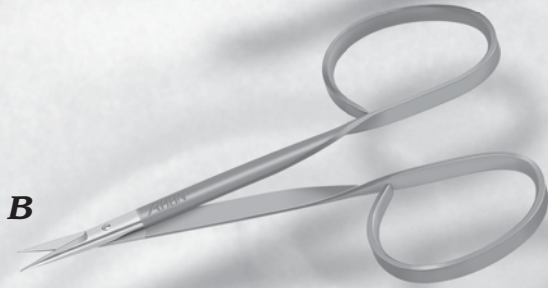

B



C



D



E



F

Iris Scissors

- A)** 8-03321 Bonn Miniature, Curved 3-1/2" w/15mm Blades
- 8-03320 Bonn Miniature, Straight 3-1/2" w/15mm Blades
- B)** 8-03318 Iris Scissors 3 1/2" Straight, 14mm Ribbon Handle
- 8-03319 Iris Scissors 3 1/2" Curved, 14mm Ribbon Handle
- C)** 8-03333 Iris Scissors 4", Curved, Small Blades, Sharp Tips
- D)** 8-03301 Iris Scissors 4", Straight Sharp Points
- 8-03302 Iris Scissors 4", Curved Sharp Points
- 8-03332 Iris Scissors 4", Straight, Small Blades, Sharp Tips
- E)** 8-03312 Iris Scissors, 3.5", 20mm Blades, Sharp, Straight
- 8-03313 Iris Scissors, 3.5", 20mm Blades, Sharp, Curved
- F)** 8-03415 Barraquer Iris Scissors, Blunt, 7mm Blades

25.04



ELEVATING THE QUALITY OF CARE IN OPHTHALMOLOGY
800-637-4346



1-800-263-3557



A



B

Miscellaneous Scissors

- A)** 8-03614 Enucleation Scissors 5", Light Curve
- 8-03615 Enucleation Scissors 5", Medium Curve
- 8-03616 Enucleation Scissors 5", Full Curve
- B)** 8-03610 Strabismus Scissors 4", Curved, Standard
- 8-03609 Strabismus Scissors 4", Straight, Standard
- C)** 8-03611 Strabismus Scissors 4-1/4", Straight, Ribbon
- 8-03612 Strabismus Scissors 4-1/4", Curved, Ribbon
- D)** 8-03617 Mansur-Aran Graft Harvesting & Pterygium Debulking Scissors



C

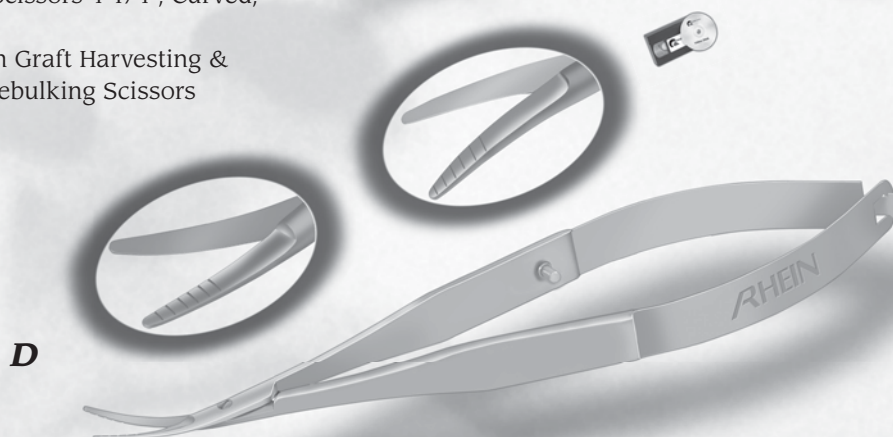

D

25.05



SCISSORS

Stitch Scissors

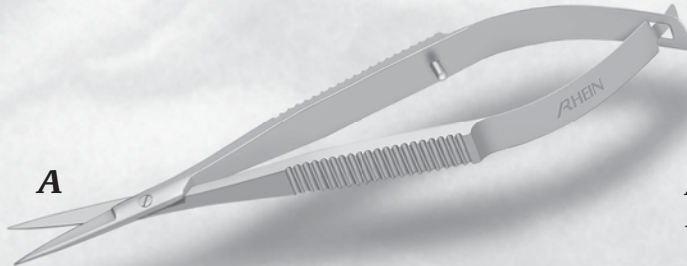

A

A) 8-03403

Fine Stitch Scissors, Straight Sharp Tips
Little Suture Caring Scissors, 4-5/8" w/
Suture Hole, Curved

B) 8-03416

8-03404

Fine Stitch Scissors, Curved Sharp Tips
McPherson/Westcott, Sharp Points,
Small Blades

C) 8-03401

D) 8-03405

Westcott Stitch 4-1/2", Curved Sharp
Points



B

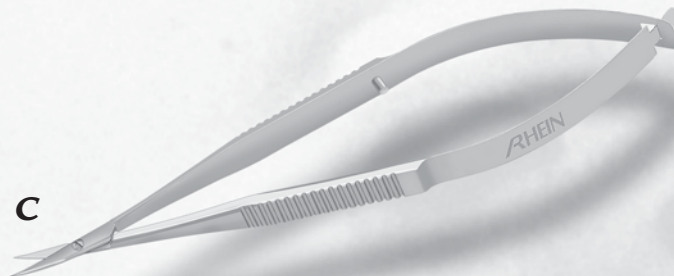

C

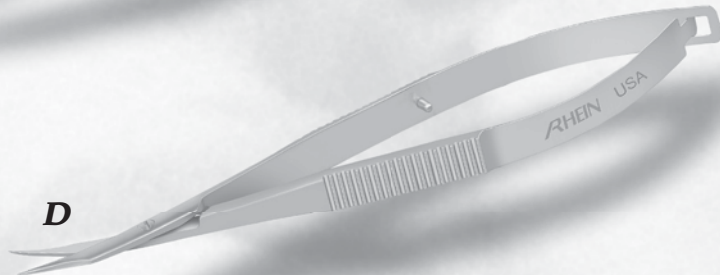

D

25.06



ELEVATING THE QUALITY OF CARE IN OPHTHALMOLOGY
800-637-4346



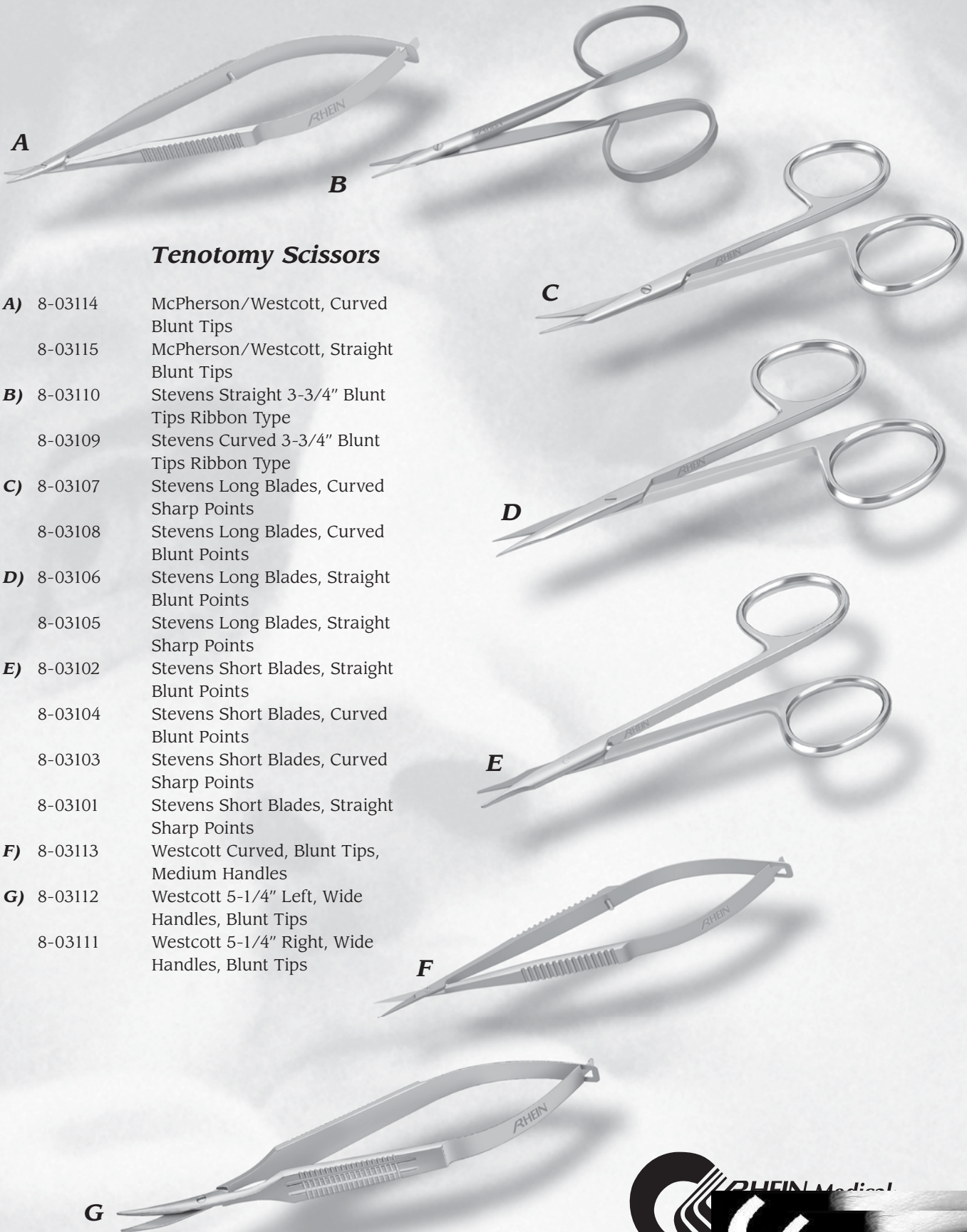

Tenotomy Scissors

- A)** 8-03114 McPherson/Westcott, Curved Blunt Tips
- 8-03115 McPherson/Westcott, Straight Blunt Tips
- B)** 8-03110 Stevens Straight 3-3/4" Blunt Tips Ribbon Type
- 8-03109 Stevens Curved 3-3/4" Blunt Tips Ribbon Type
- C)** 8-03107 Stevens Long Blades, Curved Sharp Points
- 8-03108 Stevens Long Blades, Curved Blunt Points
- D)** 8-03106 Stevens Long Blades, Straight Blunt Points
- 8-03105 Stevens Long Blades, Straight Sharp Points
- E)** 8-03102 Stevens Short Blades, Straight Blunt Points
- 8-03104 Stevens Short Blades, Curved Blunt Points
- 8-03103 Stevens Short Blades, Curved Sharp Points
- 8-03101 Stevens Short Blades, Straight Sharp Points
- F)** 8-03113 Westcott Curved, Blunt Tips, Medium Handles
- G)** 8-03112 Westcott 5-1/4" Left, Wide Handles, Blunt Tips
- 8-03111 Westcott 5-1/4" Right, Wide Handles, Blunt Tips

25.07

AHEIN Medical
ACOR
ELEVATING THE QUALITY



SPECULUMS



Most of our speculums are made of stainless steel, unless otherwise noted. Aspirating speculums have silicone tubing which is autoclaveable, and replacement tubing is available upon request. Attach the tubing to the operating room suction at a low setting to aspirate BSS runoff and remove pooling from the operative site. Aspiration may also be accomplished by using a syringe, or vacuum pump. Contact Rhein Medical for recommended cleaning and flushing.

Nasal Speculums:

Are specifically designed to rest on the nasal bridge. Available with solid or wire blades.

Reversible Speculums:

Are designed to rest on either the nasal bridge or the temporal side by flipping the speculum. Available with solid or wire blades.

Temporal Speculums:

Are specifically designed to rest on the temporal side. Available with solid or wire blades.

26.00



ELEVATING THE QUALITY OF CARE IN OPHTHALMOLOGY
800-637-4346



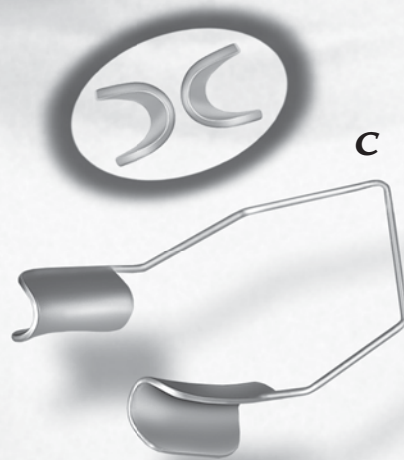
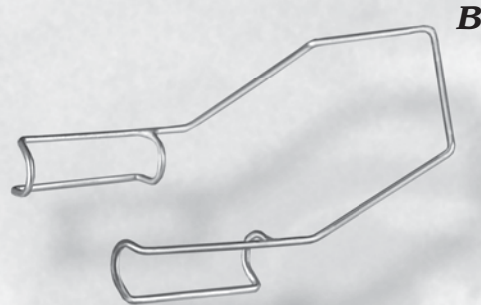
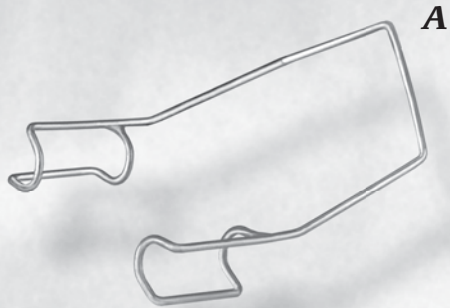

Nasal

- A)** 8-08101-T Barraquer Wire Speculum, Small Blades, Nasal Fit
- B)** 8-08102-T Barraquer Wire Speculum, Large Blades, Nasal Fit
- C)** 8-08104-T Barraquer Wire Speculum, Large Solid Blades, Nasal Fit
- D)** 8-08105-T Kratz/Barraquer Wire Speculum, Nasal Fit

26.01



ELEVATING THE QUALITY



1-800-263-3557



SPECULUMS

Nasal

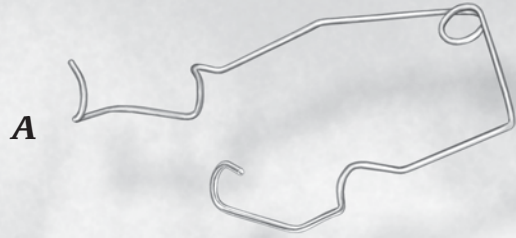

A

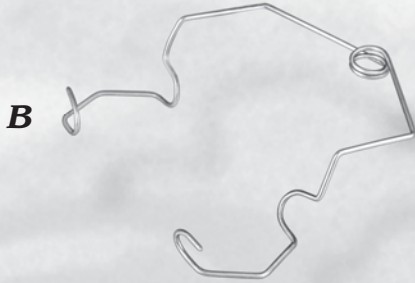

B

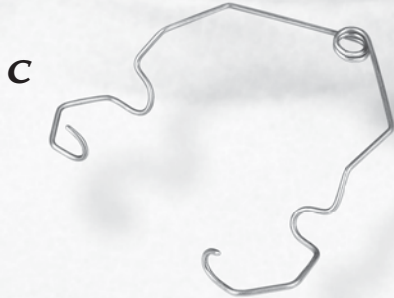

C

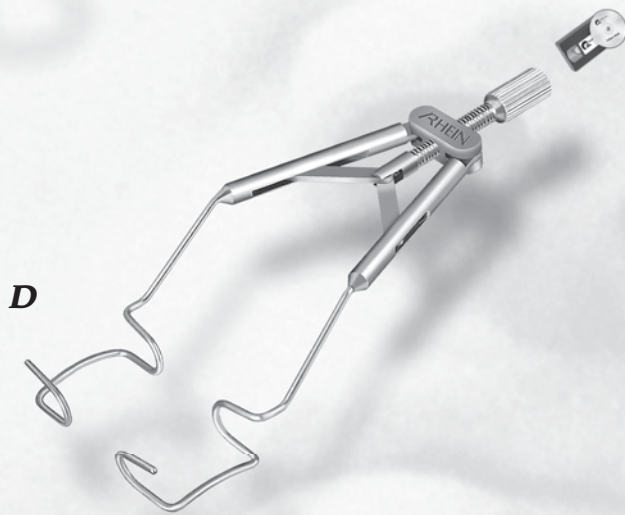

D

Nasal

- A) 8-08111 McIntyre Speculum, Nasal Fit
- B) 8-08143 New McIntyre Speculum, Nasal Fit
- C) 8-08145 Serdarevic Fixation Speculum, Nasal Fit
- D) 8-08147 Steinert Nasal Speculum, Nasal Fit

26.02



ELEVATING THE QUALITY OF CARE IN OPHTHALMOLOGY
800-637-4346



1-800-263-3557

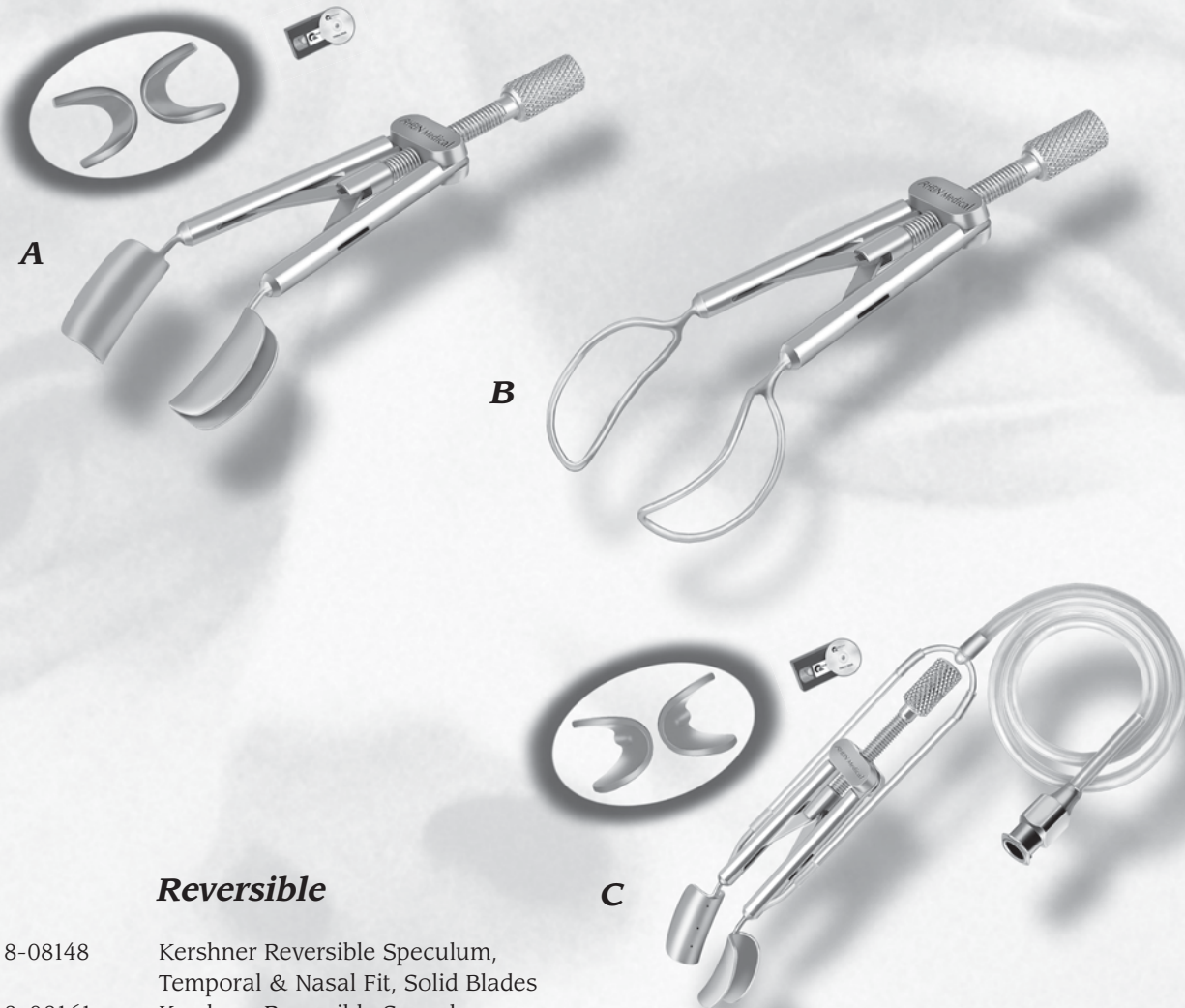

Reversible

- A)** 8-08148 Kershner Reversible Speculum, Temporal & Nasal Fit, Solid Blades
- B)** 8-08161 Kershner Reversible Speculum, Temporal & Nasal Fit, Fenestrated Blades
- C)** 8-08149 Lindstrom-Chu Aspiration Speculum, Temporal & Nasal Fit

26.03



SPECULUMS

Temporal

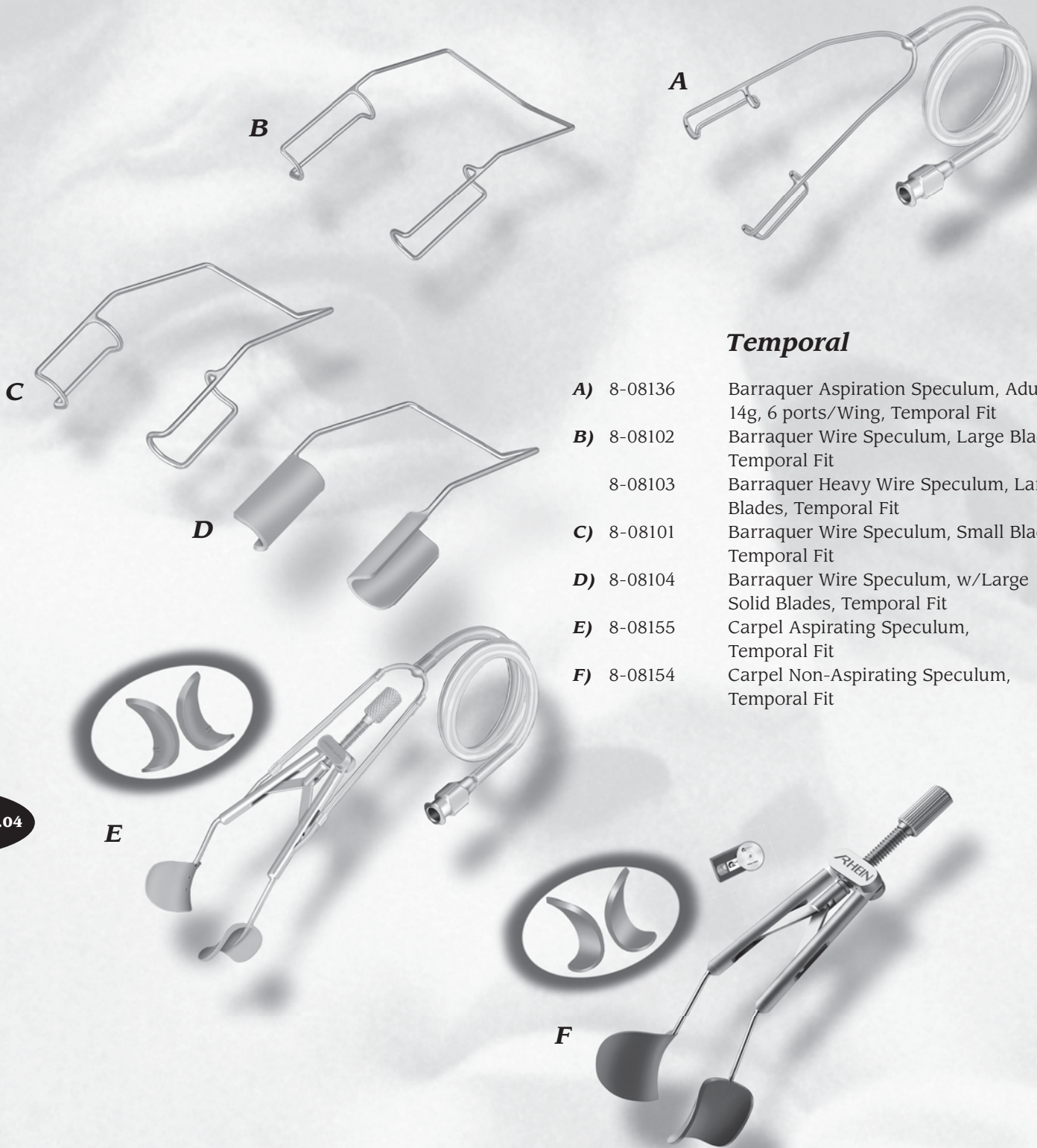

Temporal

- A) 8-08136 Barraquer Aspiration Speculum, Adult, 14g, 6 ports/Wing, Temporal Fit
- B) 8-08102 Barraquer Wire Speculum, Large Blades, Temporal Fit
- 8-08103 Barraquer Heavy Wire Speculum, Large Blades, Temporal Fit
- C) 8-08101 Barraquer Wire Speculum, Small Blades, Temporal Fit
- D) 8-08104 Barraquer Wire Speculum, w/Large Solid Blades, Temporal Fit
- E) 8-08155 Carpel Aspirating Speculum, Temporal Fit
- F) 8-08154 Carpel Non-Aspirating Speculum, Temporal Fit

26.04



ELEVATING THE QUALITY OF CARE IN OPHTHALMOLOGY
800-637-4346



1-800-263-3557



A

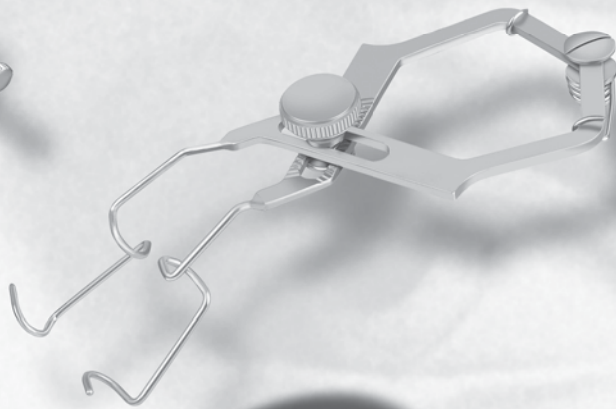

B

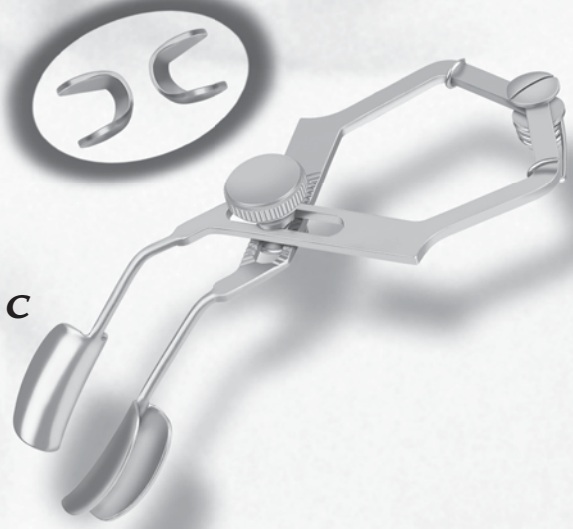

C

Temporal

- A)** 8-08135 Cook 1-7/8", Child Size, 11mm Blades, Temporal Fit
- 8-08134 Cook 1-7/8", Infant Size, 9mm Blades, Temporal Fit
- B)** 8-08163 Feaster Speculum, Open Wire Blades
- C)** 8-08162 Feaster Speculum, Solid Blades
- D)** 8-08107 Kratz Barraquer Pediatric Speculum, Temporal Fit
- E)** 8-08108 Infant Wire Speculum, 4mm Blades, Barraquer Style, Temporal Fit
- F)** 8-08112 Infant Wire Speculum, 4mm Blades, Slim Line, Temporal Fit

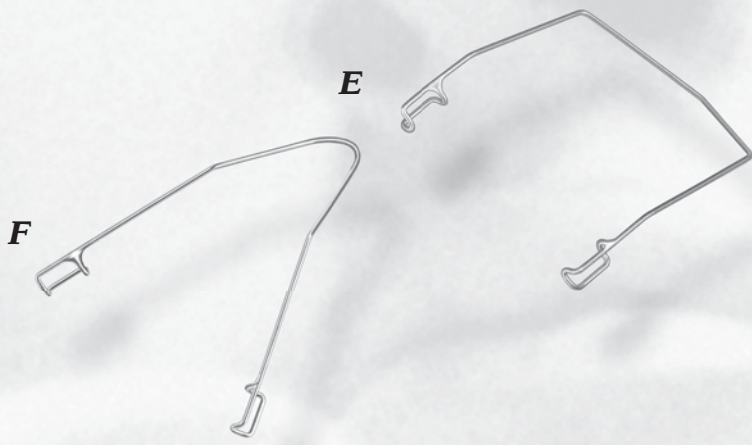

E

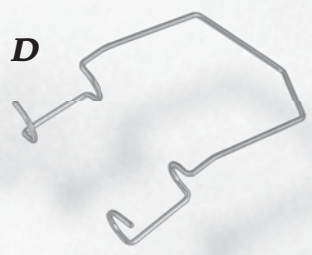

D

26.05



SPECULUMS

Temporal

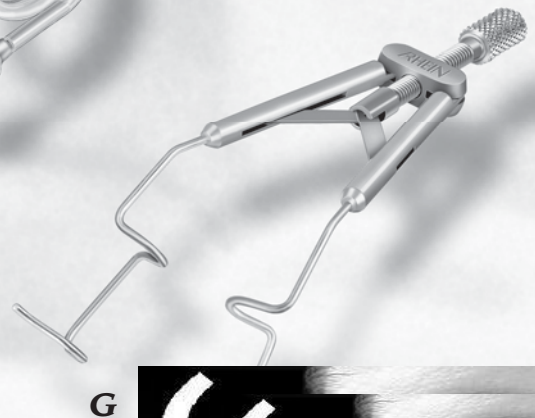
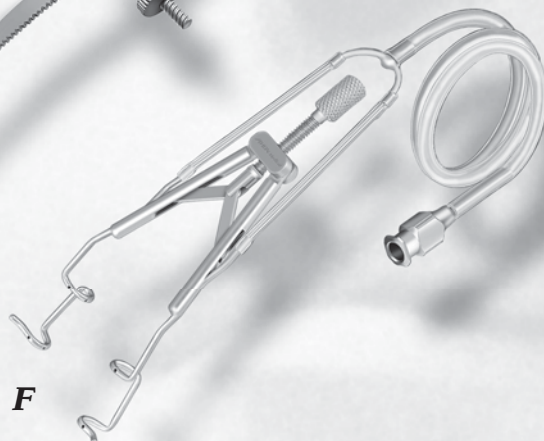
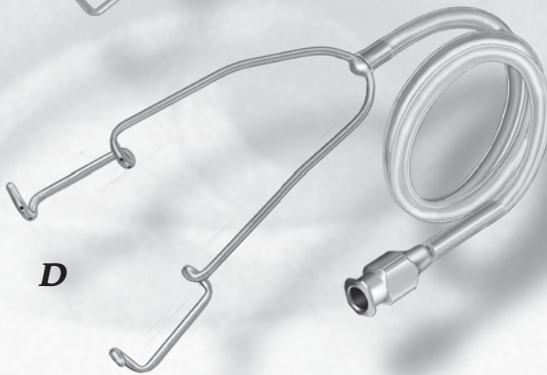
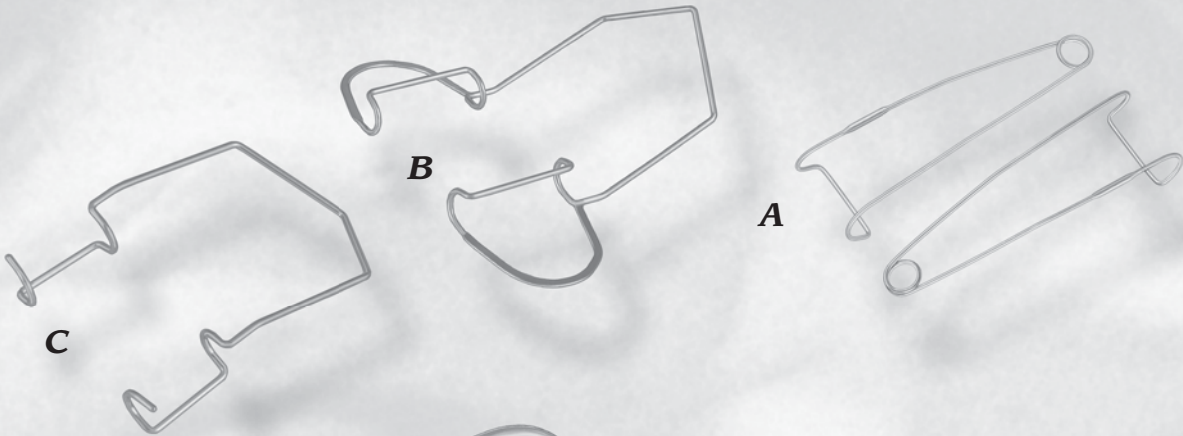

Temporal

- A)** 8-08109 Jaffe Lid Retractors (Pair)
- B)** 8-08106 Kratz Wire Speculum w/Wings, Temporal Fit
- C)** 8-08105 Kratz/Barraquer Wire Speculum, Adult, Temporal Fit
- D)** 8-08138 Kratz/Barraquer w/Aspiration, Adult, 14g, 6 Ports/Wing, Temporal Fit
- 8-08139 Kratz/Barraquer w/Aspiration, Child, 14g, 6 Ports/Wing, Temporal Fit
- E)** 8-08114 Lancaster 3-1/4", Blades 15x5mm, Temporal Fit
- F)** 8-08157-A Lieberman Open Wire Kratz Style Speculum w/Aspiration, Temporal Fit
- G)** 8-08157 Lieberman Open Wire Kratz Style Speculum, Temporal Fit

26.06



ELEVATING THE QUALITY OF CARE IN OPHTHALMOLOGY
800-637-4346



1-800-263-3557

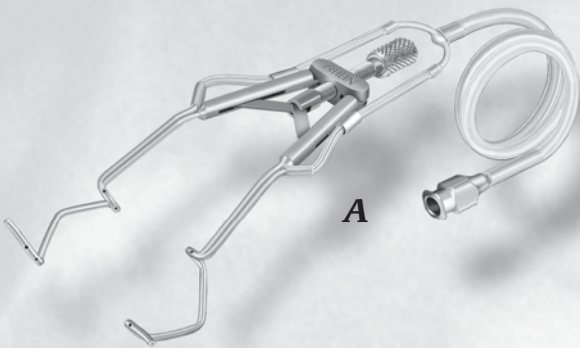

A

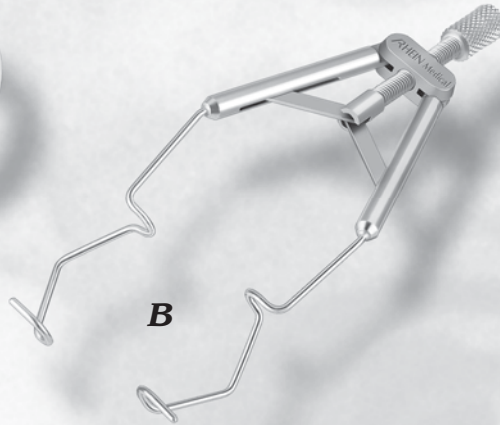

B

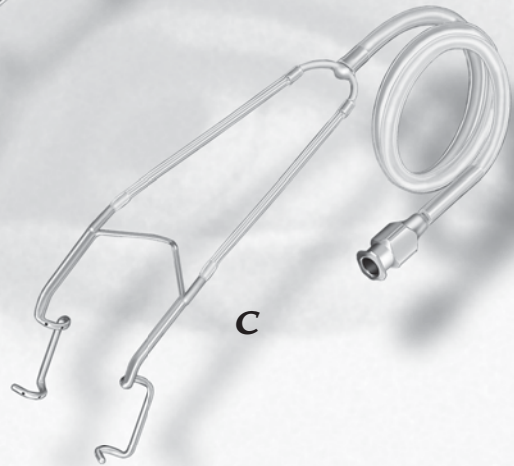

C

Temporal

- A)** 8-08146-A Lieberman Speculum, V-Wire, Aspirating, Temporal Fit
- B)** 8-08146 Lieberman Speculum, V-Wire, Temporal Fit
- C)** 8-08156 Pettigrove Aspirating LASIK Speculum, Temporal Fit
- D)** 8-08130 Sauer 1-1/4", Infant Size, 10mm Blades, Temporal Fit
- E)** 8-08160 Seibel 3-D Speculum



D

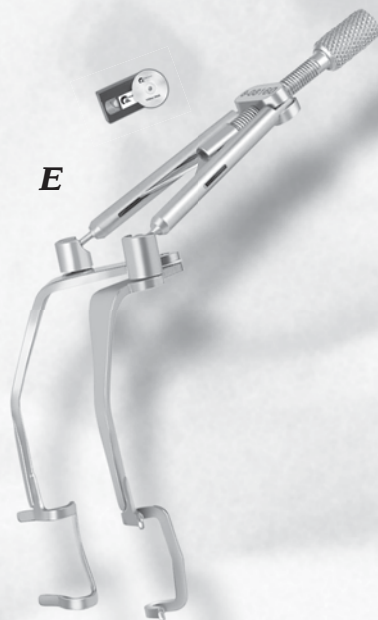

E

26.07



ELEVATING THE QUALITY



1-800-263-3557



SPECULUMS

Temporal

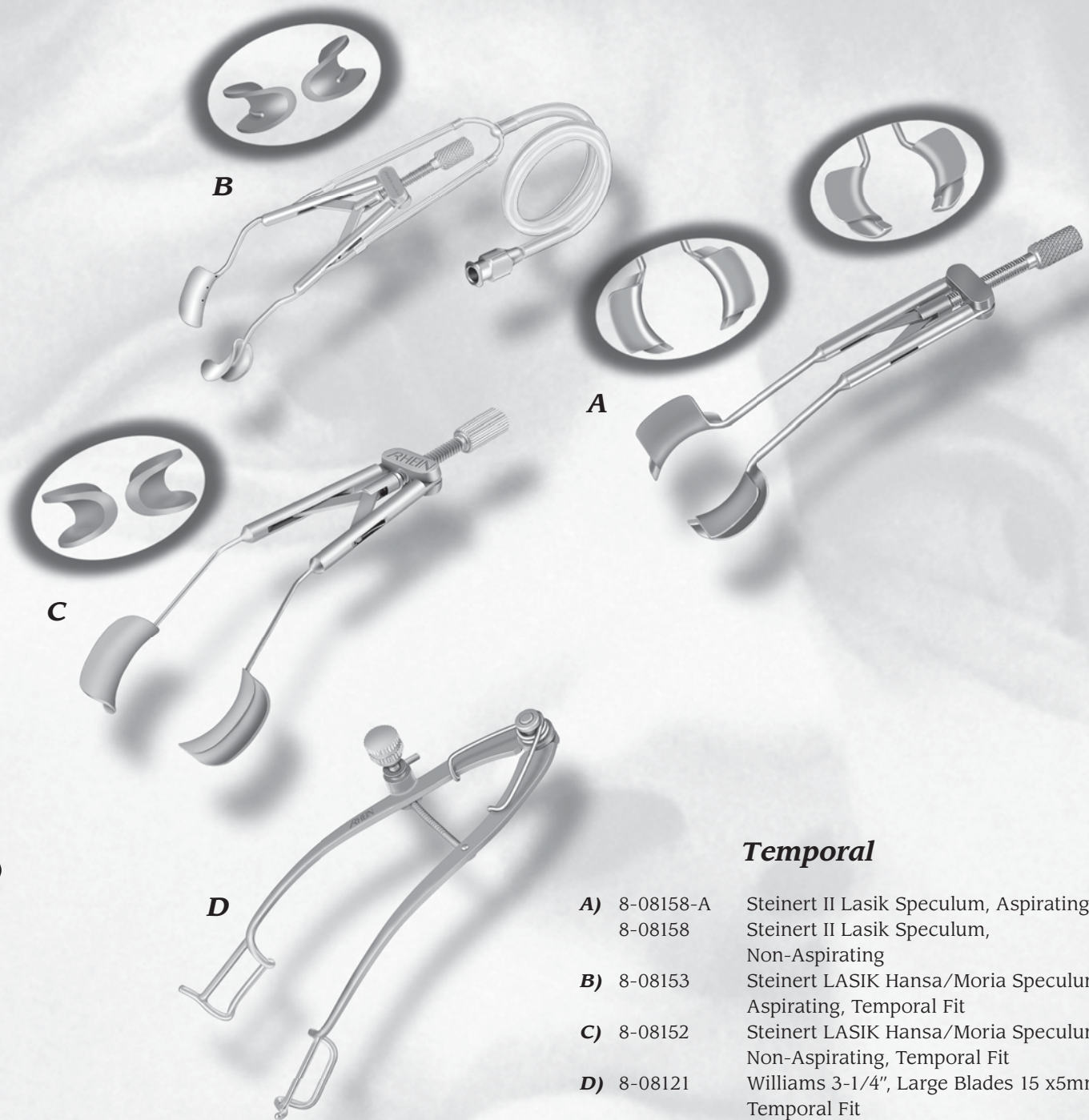

Temporal

- A)** 8-08158-A Steinert II Lasik Speculum, Aspirating
8-08158 Steinert II Lasik Speculum, Non-Aspirating
- B)** 8-08153 Steinert LASIK Hansa/Moria Speculum, Aspirating, Temporal Fit
- C)** 8-08152 Steinert LASIK Hansa/Moria Speculum, Non-Aspirating, Temporal Fit
- D)** 8-08121 Williams 3-1/4", Large Blades 15 x5mm, Temporal Fit
8-08122 Williams 2-3/4", Small Blades 11x5mm, Temporal Fit

26.08



ELEVATING THE QUALITY OF CARE IN OPHTHALMOLOGY
800-637-4346



1-800-263-3557

26.09



ELEVATING THE QUALITY

1-800-263-3557

STERILIZATION TRAYS

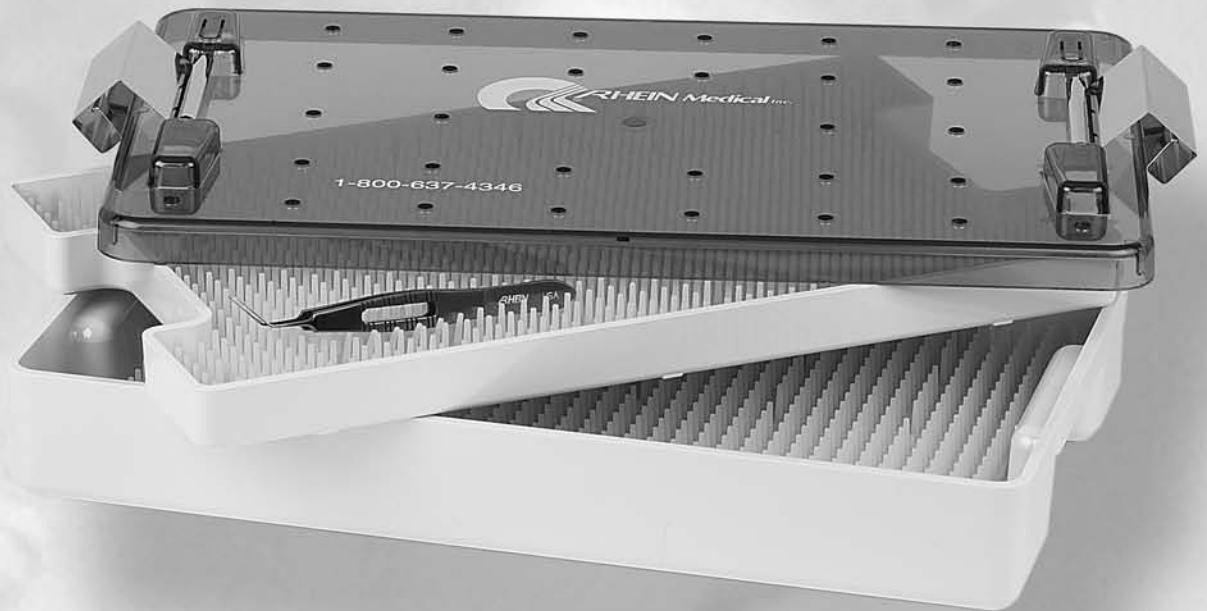

Sterilization Trays:

Our trays are made of a special polymer plastic designed to withstand repeated autoclave cycles. The trays can be used for ethylene oxide, steam, chemical, and heat sterilization procedures. The inner mats are made of soft silicone to protect your instruments during sterilization and storage. The transparent lids offer full visualization of your instruments. The trays are offered in single or double stacking models. Although these product numbers start with "05", these trays are not made of titanium, but rather made of polymer plastic.

27.00



ELEVATING THE QUALITY OF CARE IN OPHTHALMOLOGY
800-637-4346



STERILIZATION TRAYS

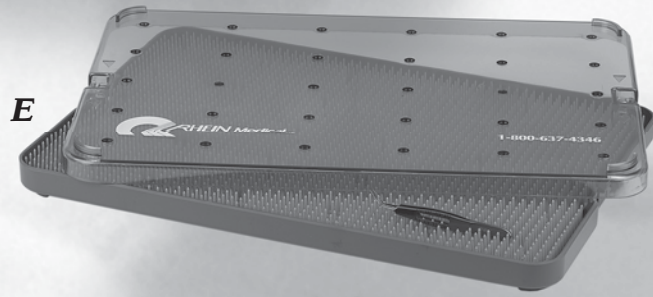
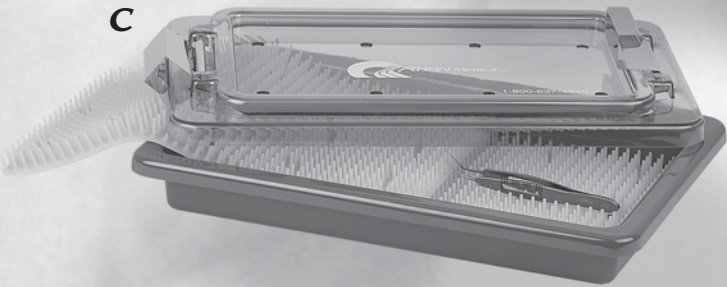

- A)** 05-6010 Diamond Knife Tray, Double Slots
- 05-6011 Diamond Knife Tray, Triple Slots
- 05-6022 Diamond Knife Tray, Single Slot, 2" x 6"
- B)** 05-6021 Sterilization Tray, 2" x 6"
- C)** 05-6015 Double Sterilization Tray, 6" x 9"
- 05-6012 Sterilization Tray, 6" x 9"
- 05-6012-M Mat For 6" x 9" Tray
- 05-6013 Sterilization Tray, 8" x 13"
- 05-6014 Double Sterilization Tray, 8" x 13"
- 05-6014-M Mat For 8" x 13" Tray
- D)** 05-6016 Double Sterilization Tray, 11" x 14"
- E)** 05-6017 Single Sterilization Tray, 11" x 14"
- 05-6017-M Mat For 11" x 14" Tray

27.01



ELEVATING THE QUALITY



1-800-263-3557



STERILIZATION TRAYS

A

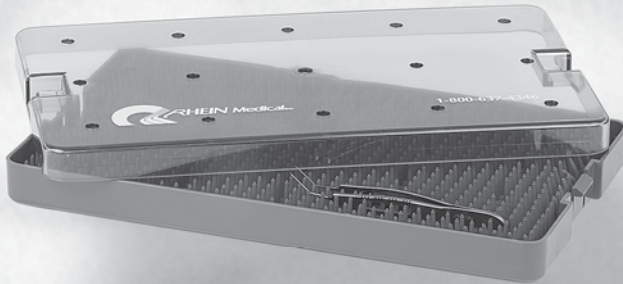

B

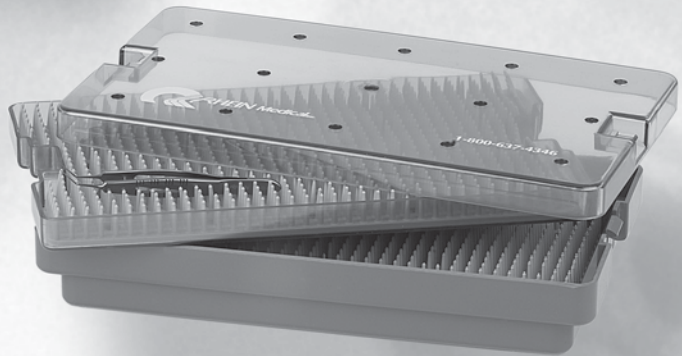

- A)** 05-6018 Single Stack Tray, 6" x 10" x 0.75"
- B)** 05-6019 Double Stack Tray, 6" x 10" x 1.5"
- 05-6020 Single Sterilization Tray 7.5" x 4"
- C)** 05-6023 Double Stack Tray, 7" x 11"
- 05-6023-M Mat For 7"x11" Tray #05-6023

C

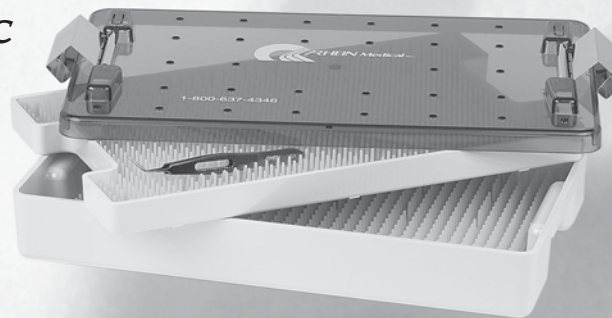

27.02



ELEVATING THE QUALITY OF CARE IN OPHTHALMOLOGY
800-637-4346



STERILIZATION TRAYS

Notes

27.03



ELEVATING THE QUALITY



ACOR

1-800-263-3557



TREPHINES



28.00



ELEVATING THE QUALITY OF CARE IN OPHTHALMOLOGY
800-637-4346



1-800-263-3557

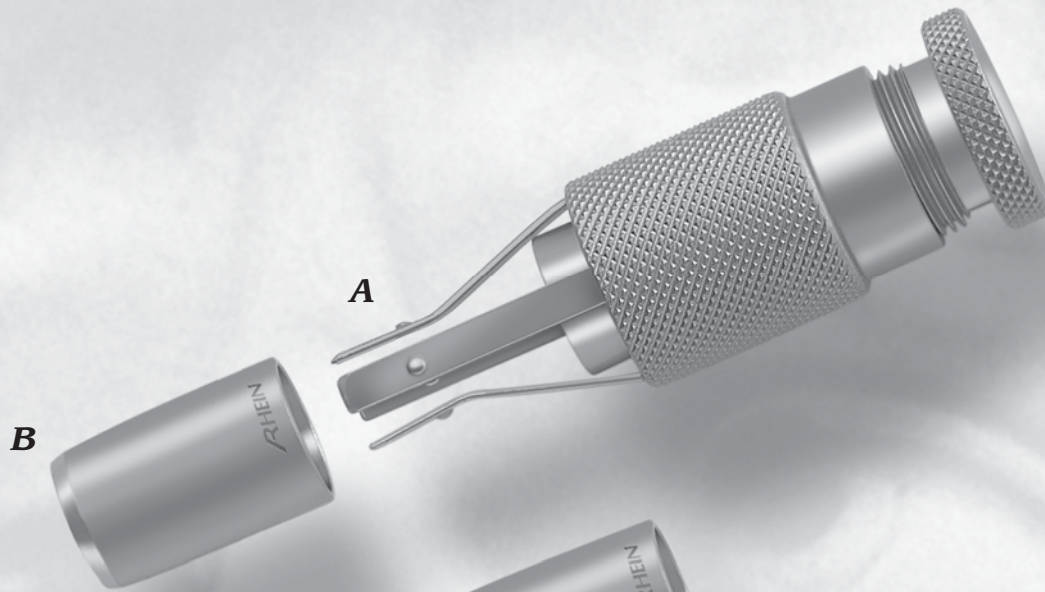

A

B

C

D

E

F

- A)** 8-10249 Universal Trephine Blade Handle
- B)** 8-10250 Trephine Blade (Long) 5.00mm
- 8-10255 Trephine Blade (Long) 5.50mm
- 8-10260 Trephine Blade (Long) 6.00mm
- 8-10265 Trephine Blade (Long) 6.50mm
- C)** 8-10270 Trephine Blade (Long) 7.00mm
- 8-10272 Trephine Blade (Long) 7.20mm
- 8-10275 Trephine Blade (Long) 7.50mm
- 8-10276 Trephine Blade (Long) 7.75mm
- 8-10277 Trephine Blade (Long) 7.70mm
- D)** 8-10280 Trephine Blade (Long) 8.00mm
- 8-10282 Trephine Blade (Long) 8.20mm
- 8-10283 Trephine Blade (Long) 8.25mm
- 8-10285 Trephine Blade (Long) 8.50mm
- 8-10287 Trephine Blade (Long) 8.70mm
- E)** 8-10290 Trephine Blade (Long) 9.00mm
- 8-10295 Trephine Blade (Long) 9.50mm
- 8-10297 Trephine Blade (Long) 9.70mm
- F)** 8-10298 Trephine Blade (Long) 10.00mm
- 8-10299 Trephine Blade (Long) 11.00mm

28.01



ELEVATING THE QUALITY



1-800-263-3557



VITRECTOMY INSTRUMENTS



29.00



ELEVATING THE QUALITY OF CARE IN OPHTHALMOLOGY
800-637-4346



1-800-263-3557

VITRECTOMY INSTRUMENTS

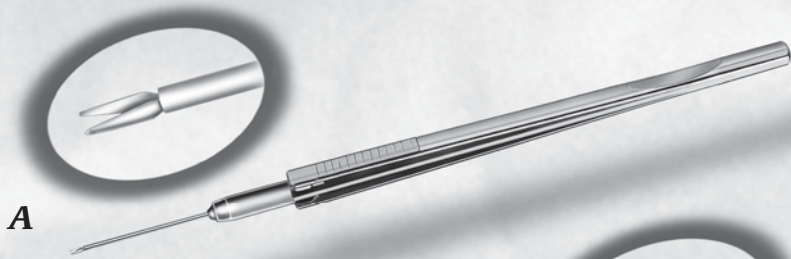

A

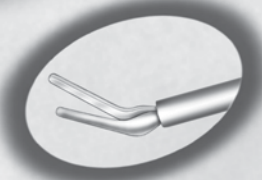

B

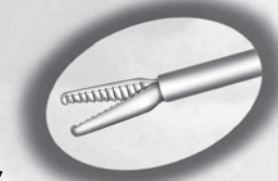

C



D

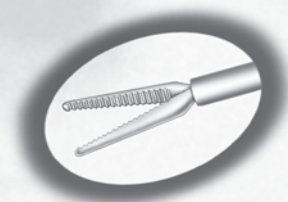

E

- A)** 01-2350-SN Grasping Forceps, Smooth, Non-Irrigating Silver Handle, 25 Gauge
- B)** 01-2370-SN Grasping Forceps, Smooth, 45 Degrees, Non-Irrigating Silver Handle, 25 Gauge
- C)** 01-2400-SN Grasping Forceps w/Serrations, Non-Irrigating Silver Handle, 25 Gauge
- D)** 01-2410-SN Grasping Forceps w/Serrations, 30 Degrees, Non-Irrigating Silver Handle, 25 Gauge
- E)** 01-2450-SN Grasping Forceps w/Long Straight, Serrated Jaws, Silver Handle, 25 Gauge

29.01



ELEVATING THE QUALITY



ACOR

1-800-263-3557



VITRECTOMY INSTRUMENTS

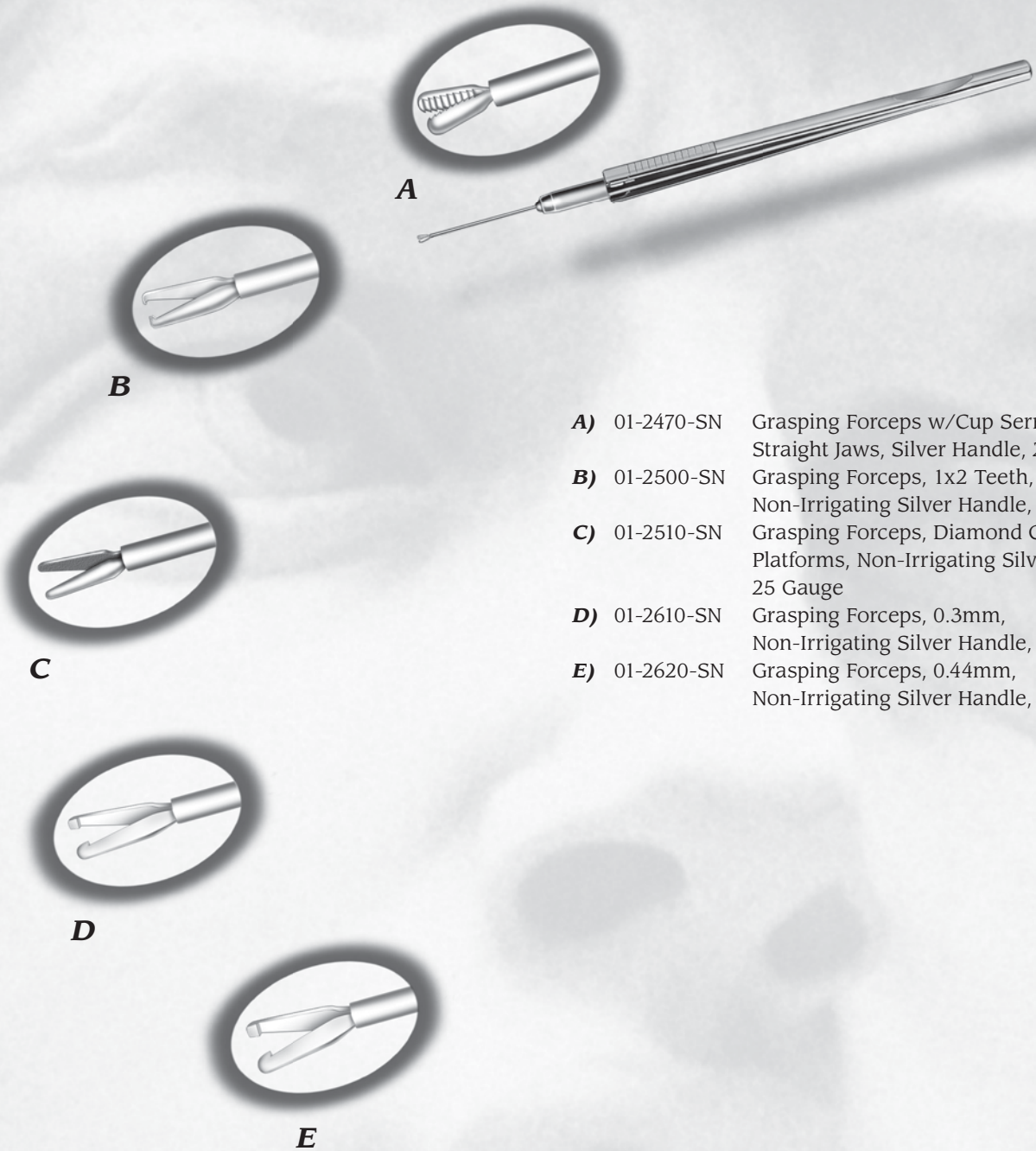

- A)** 01-2470-SN Grasping Forceps w/Cup Serrated Straight Jaws, Silver Handle, 25 Gauge
- B)** 01-2500-SN Grasping Forceps, 1x2 Teeth, Non-Irrigating Silver Handle, 25 Gauge
- C)** 01-2510-SN Grasping Forceps, Diamond Coated Platforms, Non-Irrigating Silver Handle, 25 Gauge
- D)** 01-2610-SN Grasping Forceps, 0.3mm, Non-Irrigating Silver Handle, 25 Gauge
- E)** 01-2620-SN Grasping Forceps, 0.44mm, Non-Irrigating Silver Handle, 25 Gauge

29.02



ELEVATING THE QUALITY OF CARE IN OPHTHALMOLOGY
800-637-4346



1-800-263-3557

VITRECTOMY INSTRUMENTS

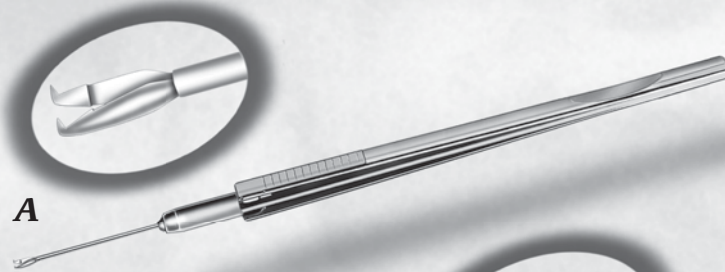

A

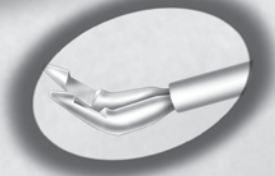

B



C



D



E



F

- A)** 01-2640-SN Grasping Forceps, Non-Irrigating Silver Handle, 25 Gauge, 90 Degrees
- B)** 01-2660-SN Grasping Forceps, 45 Degrees, Non-Irrigating Silver Handle, 25 Gauge
- C)** 01-3020-SN Grasping Forceps, Smooth, 45 Degrees, Non-Irrigating Silver Handle, 25 Gauge
- D)** 01-3030-SN Grasping Forceps, Smooth, 45 Degrees, Non-Irrigating Silver Handle, 25 Gauge
- E)** 01-3040-SN Grasping Forceps, Smooth, 60 Degrees, Non-Irrigating Silver Handle, 25 Gauge
- F)** 01-3080-SN Grasping Forceps w/Serrations, 60 Degrees, Irrigating Silver Handle, 25 Gauge

29.03



ELEVATING THE QUALITY



ACOR

1-800-263-3557



VITRECTOMY INSTRUMENTS

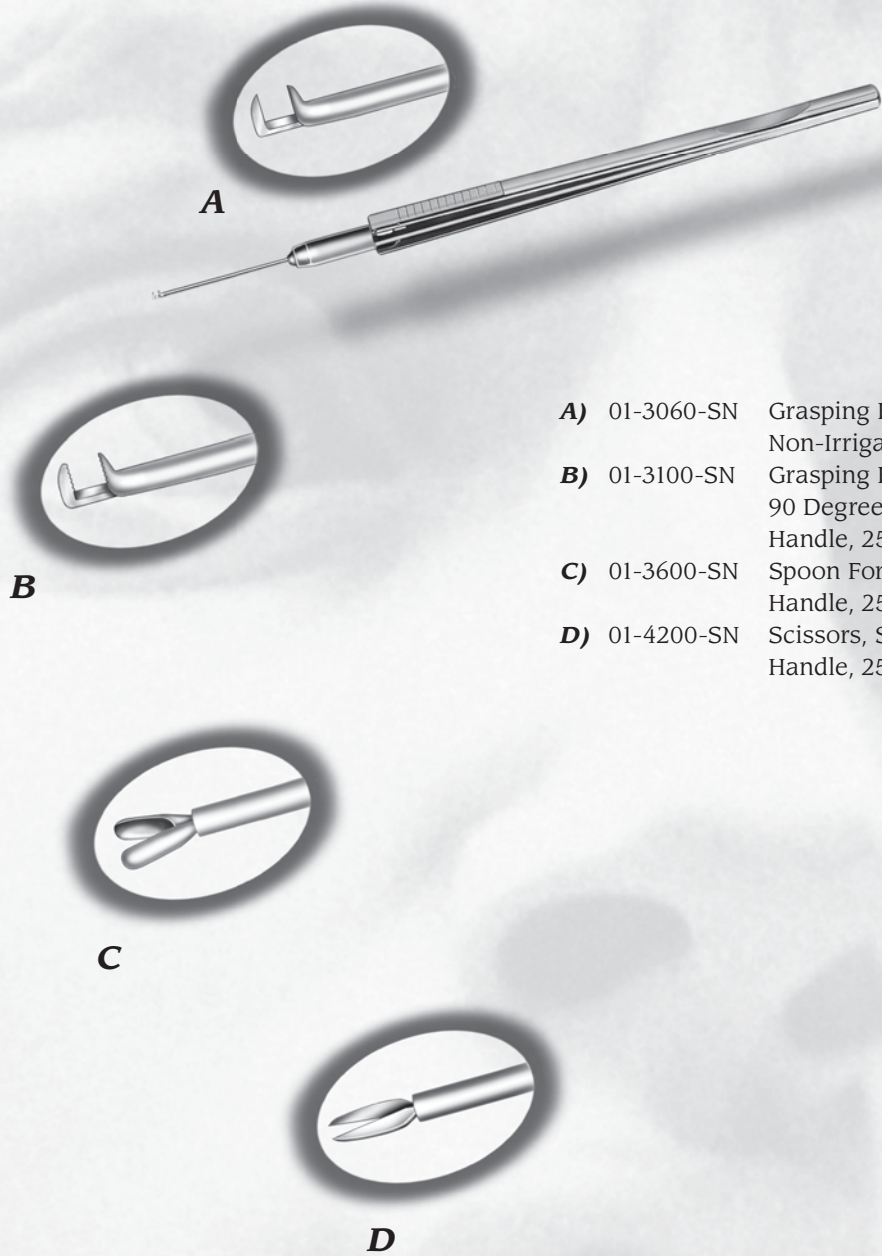

- A)** 01-3060-SN Grasping Forceps, Smooth, 90 Degrees, Non-Irrigating Silver Handle, 25 Gauge
- B)** 01-3100-SN Grasping Forceps w/Serrations, 90 Degrees, Non-Irrigating Silver Handle, 25 Gauge
- C)** 01-3600-SN Spoon Forceps, Non-Irrigating Silver Handle, 25 Gauge
- D)** 01-4200-SN Scissors, Straight, Non-Irrigating Silver Handle, 25 Gauge

29.04



ELEVATING THE QUALITY OF CARE IN OPHTHALMOLOGY
800-637-4346



1-800-263-3557

VITRECTOMY INSTRUMENTS

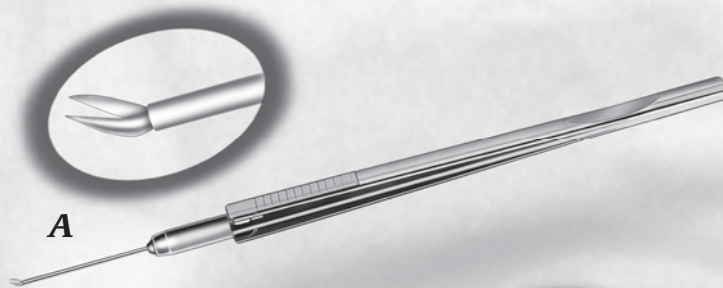

- A)** 01-4210-SN Scissors, Angled 30 Degrees, Non-Irrigating Silver Handle, 25 Gauge
- B)** 01-7160-SN Scissors, Angled 60 Degrees, Non-Irrigating Silver Handle, 25 Gauge
- C)** 01-7170-SN Scissors w/Scoop Tip, Angled 60 Degrees, Non-Irrigating Silver Handle, 25 Gauge
- D)** 01-7180-SN Scissors, Angled 90 Degrees, Non-Irrigating Silver Handle, 25 Gauge



29.05



ELEVATING THE QUALITY

ACOR

1-800-263-3557



NUMERICAL INDEX

01-2350-SN >>> 05-4037

NUMBER	PAGE	PHOTO	NUMBER	PAGE	PHOTO	NUMBER	PAGE	PHOTO
01-2350-SN	29.01	A	03-5030	3.02	D	05-2325	13.29	A
01-2370-SN	29.01	B	03-6150	3.03		05-2326	13.06	D
01-2400-SN	29.01	C	03-6225	3.03		05-2327	13.05	C
01-2410-SN	29.01	D	03-6300	3.03		05-2328	13.05	B
01-2450-SN	29.01	E	03-6450	3.03	A	05-2329	13.05	A
01-2470-SN	29.02	A	05-1010	21.03	C	05-2330	13.29	
01-2500-SN	29.02	B	05-1011	21.03		05-2331	13.21	D
01-2510-SN	29.02	C	05-1014	21.03		05-2331-L	13.21	
01-2610-SN	29.02	D	05-1015	21.03		05-2332	13.21	C
01-2620-SN	29.02	E	05-1018	21.03		05-2333	13.21	F
01-2640-SN	29.03	A	05-1019	21.03	A	05-2334	13.21	
01-2660-SN	29.03	B	05-1022	21.03		05-2334-A	13.21	
01-3020-SN	29.03	C	05-1023	21.03		05-2334-AL	13.21	E
01-3030-SN	29.03	D	05-1026	21.03	D	05-2334-L	13.21	
01-3040-SN	29.03	E	05-1027	21.03		05-2335	13.37	B
01-3060-SN	29.04	A	05-1030	21.03		05-2336	13.24	E
01-3080-SN	29.03	F	05-1031	21.03		05-2338-R	13.24	D
01-3100-SN	29.04	B	05-1034	21.03		05-2339-R	13.24	F
01-3600-SN	29.04	C	05-1035	21.03		05-2340	13.29	C
01-4200-SN	29.04	D	05-1038	21.03	B	05-2341-R	13.24	
01-4210-SN	29.05	A	05-1039	21.03		05-2342	13.23	C
01-7160-SN	29.05	B	05-2111	13.43	B	05-2344	13.23	B
01-7170-SN	29.05	C	05-2112	13.41	A	05-2346	13.24	A
01-7180-SN	29.05	D	05-2115	13.43	C	05-2348	13.23	D
02-2000	1.01	A	05-2116	13.41	B	05-2349	13.24	B
02-2020	1.01	B	05-2119	13.42	B	05-2350	13.24	C
02-5000	1.01	C	05-2120	13.42		05-2351	13.37	A
02-5001	1.01	D	05-2123	13.41	D	05-2355	13.21	
02-5015	1.01	E	05-2124	13.42	A	05-2356	13.21	B
03-0250	3.01		05-2127	13.41	C	05-2357	13.21	A
03-0250-F	3.01		05-2130	13.43	A	05-2360	13.05	D
03-0265	3.01		05-2131	13.42	D	05-2361	13.06	B
03-0265-F	3.01		05-2134	13.42	C	05-2362	13.07	A
03-0280	3.01		05-2211	13.19	B	05-2375	13.23	A
03-0280-F	3.01		05-2212	13.19		05-2376	13.22	E
03-0300	3.01		05-2215	13.18		05-2377	13.22	D
03-0300-F	3.01	A	05-2216	13.18	A	05-2400	13.22	B
03-0320	3.01		05-2217	13.18		05-2402	13.22	C
03-0320-F	3.03		05-2218	13.19	C	05-2410	13.22	A
03-1530	3.03	B	05-2220	13.18	B	05-4011	15.06	
03-1550	3.03	B	05-2221	13.18		05-4012	15.06	
03-2535	3.01	B	05-2224	13.18	D	05-4013	15.01	
03-3006	3.01		05-2225	13.18	C	05-4016	15.07	
03-3007	3.01		05-2226	13.18		05-4017	15.04	
03-3008	3.01		05-2229	13.18	E	05-4018	15.04	
03-3009	3.01		05-2232	13.19	A	05-4020	15.01	
03-3010	3.01	D	05-2233	13.34	B	05-4025	15.04	
03-3011	3.01		05-2311	13.29	B	05-4026	15.04	B
03-3014	3.01		05-2312	13.30	A	05-4030	15.09	E
03-3015	3.01	C	05-2313	13.27	C	05-4032	15.10	B
03-3030	3.03		05-2314	13.27	A	05-4034-L	7.02	
03-3035	3.03	C	05-2318	13.07	B	05-4034-R	7.02	B
03-4022	3.01	E	05-2319	13.07	C	05-4035	7.02	
03-4030	3.01	F	05-2320	13.06	C	05-4035-L	7.02	
03-5005	3.02	A	05-2321	13.05	E	05-4036	7.01	
03-5010	3.02	B	05-2322	13.07	D	05-4036-L	7.01	
03-5020	3.02	C	05-2323	13.06	A	05-4037	7.01	

30.00



ELEVATING THE QUALITY OF CARE IN OPHTHALMOLOGY
800-637-4346



NUMERICAL INDEX

05-4038 >>> 07-6027

NUMBER	PAGE	PHOTO	NUMBER	PAGE	PHOTO	NUMBER	PAGE	PHOTO
05-4038	7.03		05-5060	10.02		05-8114	24.08	
05-4039	7.04		05-5069	10.02		05-8115	10.06	B
05-4040	7.04		05-5077	10.01	A	05-8116	24.01	
05-4040-L	7.04		05-5078	10.01		05-8118	24.01	
05-4040-S	7.04		05-5079	10.01		05-8120	24.01	B
05-4040-SL	7.04		05-5080	10.01		05-8122	24.01	
05-4041	7.07		05-5081	10.01	G	05-8200	10.05	F
05-4042	7.03		05-5082	10.01		05-8202	24.02	A
05-4043	7.03	A	05-5083	10.01		05-8204	24.02	
05-4043-L	7.03		05-5084	10.01		05-8206	24.02	
05-4044	7.05		05-5085	10.01	H	05-8208	24.02	
05-4044-L	7.05		05-5086	10.01	D	05-8210	24.02	
05-4045	7.04		05-5087	10.01	B	05-8212	24.02	
05-4045-L	7.04		05-5088	10.01	C	05-8214	24.02	
05-4046	7.07		05-5089	10.01		05-8216	24.02	
05-4047	7.05		05-5090	10.01		05-8218	24.02	
05-4047-L	7.05		05-5091	10.01		05-8220	24.02	
05-4050	15.08		05-5092	10.02	E	05-8222	24.02	
05-4051	15.10		05-5094	10.01		05-8300	24.03	A
05-4052	15.10	C	05-5095	10.01	I	05-9001	10.04	A
05-4055	15.07		05-5096	10.01	E	05-9002	10.04	B
05-4055-A	15.07		05-5097	10.01	F	05-9003	10.04	G
05-4055-C	15.07		05-5098	10.02	D	05-9004	10.04	E
05-4057	7.06		05-5099	10.01		05-9005	10.04	F
05-4057-L	7.06		05-6010	27.01	A	05-9006	10.04	C
05-4058	7.06		05-6011	27.01		05-9007	10.04	D
05-4058-L	7.06		05-6012	27.01		05-9008	10.03	
05-4059	15.03	C	05-6012-M	27.01		05-9009	10.03	C
05-4060	15.03	B	05-6013	27.01		05-9010	17.01	A
05-4061	15.09	B	05-6014	27.01		05-9011	10.03	
05-4062	15.09		05-6014-M	27.01		05-9012	10.03	B
05-4063	15.09	F	05-6015	27.01	C	05-9013	10.03	D
05-4064-L	7.04		05-6016	27.01	D	05-9014	10.03	
05-4064-R	7.04		05-6017	27.01	E	05-9014-ST	10.03	
05-4065-L	7.07		05-6017-M	27.01		05-9015	10.04	H
05-4065-R	7.07		05-6018	27.02	A	05-9016	10.03	
05-4066-L	7.06		05-6019	27.02	B	05-9017	10.03	F
05-4066-R	7.06		05-6020	27.02		05-9018	10.03	
05-4067	7.05		05-6021	27.01	B	05-9019	10.03	
05-5011	10.02	B	05-6022	27.02		05-9020	10.03	A
05-5013	10.02	C	05-6023	27.02	C	05-9021	10.03	E
05-5018	10.02	A	05-6023-M	27.02		07-1023	6.01	
05-5020	10.02		05-7001	14.02		07-1025	6.01	
05-5024	10.05	A	05-7002	22.02	C	07-2023	6.01	A
05-5026	10.05	B	05-7003	22.01		07-2025	6.01	
05-5030	10.02	F	05-7004	22.02	A	07-3025	6.02	E
05-5030-S	10.02		05-7005	24.08	F	07-3027	6.02	
05-5031	10.02		05-7006	24.07	C	07-3030	6.02	
05-5032	10.02		05-7007	22.03	D	07-4023	6.01	
05-5032-S	10.02		05-8001	10.05	E	07-4025	6.01	
05-5035	10.04	C	05-8102	24.01		07-5025	6.02	A
05-5039	10.04	D	05-8104	24.01		07-5027	6.02	
05-5049-S	10.02		05-8106	24.01		07-5030	6.02	
05-5050	10.02	G	05-8108	24.01		07-5060	6.02	B
05-5050-S	10.02		05-8110	24.01		07-5125	6.02	
05-5052	10.02		05-8111	10.06	A	07-6025	6.02	D
05-5052-S	10.02		05-8112	24.08		07-6027	6.02	

30.01



NUMERICAL INDEX

07-6030 >>> 8-02102

NUMBER	PAGE	PHOTO	NUMBER	PAGE	PHOTO	NUMBER	PAGE	PHOTO
07-6030	6.02		8-01240	13.11	A	8-01392-D	13.32	B
09-6514	6.02	C	8-01241	13.11		8-01392-R	13.32	
09-6518	6.01		8-01242	13.11	B	8-01396	13.31	C
09-6519	6.01		8-01243	13.14	A	8-01397	13.30	D
09-6520	6.01		8-01248	13.12	E	8-01398	13.30	E
09-6521	6.01		8-01249	13.12		8-01401	13.01	
09-6570	6.01		8-01250	13.12		8-01402	13.01	C
09-6575	6.01		8-01251	13.12	D	8-01413	13.04	C
09-6581	6.01	B	8-01252	13.12		8-01414	13.04	D
09-6582	6.01		8-01253	13.12		8-01415	13.04	E
09-6583	6.01		8-01254	13.12	F	8-01416	13.03	A
09-6584	6.01		8-01255	13.12		8-01419	13.01	D
09-6585	6.01		8-01256	13.12		8-01420	13.01	
09-6586	6.01		8-01257	13.12		8-01421-L	13.02	A
09-7001	6.03	A	8-01258	13.12		8-01421-S	13.02	B
09-7010	6.03	B	8-01259	13.12	C	8-01422-N	13.02	C
09-7015	6.03	C	8-01261	13.16	C	8-01423	13.04	A
09-7017	10.07	B	8-01262	13.16		8-01424	13.03	C
09-7018	10.07	A	8-01265	13.11	C	8-01425	13.04	B
8-01101	13.40	A	8-01266	13.11		8-01426	13.03	D
8-01102	13.39	A	8-01270	13.15	D	8-01427	13.03	B
8-01103	13.39	B	8-01271	13.16	E	8-01428	13.02	D
8-01106	13.39		8-01280	13.11	E	8-01428-B	13.02	
8-01107	13.39	C	8-01281	13.16	D	8-01501	13.20	A
8-01108	13.38	C	8-01284	13.15		8-01502	13.20	
8-01109	13.38		8-01285	13.15	A	8-01504	13.20	B
8-01110	13.38	D	8-01291	13.14	D	8-01505	13.20	
8-01111	13.38		8-01294	13.15	B	8-01602	13.10	A
8-01114	13.40	D	8-01295	13.15	C	8-01603	13.25	A
8-01115	13.40	C	8-01298	13.17	A	8-01604	13.25	B
8-01116	13.38	B	8-01299	13.17	D	8-01605	13.25	C
8-01120	13.40		8-01300	13.34	A	8-01606	13.25	D
8-01121	13.40	B	8-01301	13.12	B	8-01607	13.26	A
8-01122	13.38		8-01302	13.12	A	8-01608	13.26	C
8-01123	13.38	A	8-01310	13.33	B	8-01609	13.26	D
8-01124	13.39	D	8-01315	13.27		8-01611	13.26	B
8-01204	13.11		8-01318	13.28	C	8-01619	13.10	C
8-01205	13.11	D	8-01322	13.27	B	8-01620	13.10	E
8-01206	13.14	B	8-01323	13.27		8-01624	13.10	B
8-01207	13.14		8-01325	13.30	B	8-01626	13.10	D
8-01208	13.13	C	8-01334	13.32	C	8-01630	13.34	C
8-01209	13.13		8-01335	13.27	D	8-01631	13.34	
8-01215	13.13	F	8-01336	13.28	A	8-01632	13.34	C
8-01216	13.13	E	8-01337	13.32	A	8-01701	13.08	
8-01217	13.16		8-01338	13.28	B	8-01702	13.08	
8-01218	13.16	A	8-01339	13.32	D	8-01703	13.08	B
8-01219	13.16		8-01340	13.30	C	8-01704	13.08	A
8-01220	13.13	B	8-01341	13.33	C	8-01705	13.08	
8-01221	13.14	E	8-01345	13.33	A	8-01706	13.08	C
8-01222	13.13	A	8-01346-A	13.33	E	8-01707	13.09	
8-01223	13.13	C	8-01346-S	13.33	F	8-01708	13.09	D
8-01224	13.16	B	8-01347	13.33	D	8-01710	13.09	C
8-01225	13.16		8-01350	13.31	A	8-01711	13.09	
8-01231	13.14	F	8-01351	13.31	B	8-01714	13.09	E
8-01234	13.17	C	8-01352	13.31	D	8-01715	13.09	B
8-01235	13.17		8-01380	13.28	D	8-02101	21.02	
8-01239	13.17	B	8-01390	13.29	D	8-02102	21.02	



NUMERICAL INDEX

8-02103 >>> 8-07121

NUMBER	PAGE	PHOTO	NUMBER	PAGE	PHOTO	NUMBER	PAGE	PHOTO
8-02103	21.02	E	8-03237	25.02		8-04227	15.06	B
8-02104	21.02		8-03242	25.03		8-04228	15.01	
8-02111	21.01		8-03243	25.03	C	8-04229	15.01	E
8-02112	21.01	B	8-03301	25.04	D	8-04230	15.05	D
8-02113	21.01		8-03302	25.04		8-04231	15.02	A
8-02114	21.01		8-03312	25.04	E	8-04233	15.04	A
8-02115	21.01		8-03313	25.04		8-04234	15.04	
8-02116	21.01		8-03318	25.04	B	8-04235	15.05	C
8-02117	21.01		8-03319	25.04		8-04236	15.04	D
8-02118	21.01	C	8-03320	25.04		8-04240	15.01	D
8-02119	21.01		8-03321	25.04	A	8-04241	15.01	
8-02120	21.01		8-03332	25.04		8-04305	15.10	
8-02125	21.01		8-03333	25.04	C	8-04306	15.10	D
8-02126	21.02		8-03401	25.06	C	8-04307	15.10	E
8-02127	21.02	B	8-03403	25.06	A	8-04308	15.10	F
8-02128	21.02		8-03404	25.06		8-04309	15.10	
8-02133	21.02	A	8-03405	25.06	D	8-04310	15.07	A
8-02134	21.02		8-03415	25.04	F	8-04311	15.09	A
8-02135	21.02		8-03416	25.06	B	8-04312	15.03	D
8-02136	21.02		8-03501	25.01		8-04401	15.11	C
8-02148	21.02	D	8-03502	25.01		8-04402	15.11	A
8-02153	21.02	C	8-03503	25.01	A	8-04403	15.11	B
8-02155	21.01		8-03504	25.01		8-04404	15.11	
8-02156	21.01	A	8-03505	25.01		8-04405	15.11	
8-02157	21.01		8-03506	25.01		8-04406	15.11	D
8-02158	21.01		8-03507	25.01	B	8-04407	15.11	
8-03101	25.07		8-03508	25.01	F	8-05101	23.01	D
8-03102	25.07	E	8-03509	25.01	E	8-05102	23.01	
8-03103	25.07		8-03510	25.01	D	8-05106	23.01	B
8-03104	25.07		8-03511	25.01	C	8-05107	23.01	E
8-03105	25.07		8-03512	25.01		8-06101	15.11	E
8-03106	25.07	D	8-03609	25.05		8-06102	15.11	
8-03107	25.07	C	8-03610	25.05	B	8-06103	15.11	
8-03108	25.07		8-03611	25.05	C	8-06104	15.11	
8-03109	25.07		8-03612	25.05		8-06105	15.11	
8-03110	25.07	B	8-03614	25.05	A	8-06106	15.11	
8-03111	25.07		8-03615	25.05		8-07101	9.03	C
8-03112	25.07	G	8-03616	25.05		8-07104	9.02	C
8-03113	25.07	F	8-03617	25.05	D	8-07105	9.02	D
8-03114	25.07	A	8-04101	15.01		8-07107	9.02	E
8-03115	25.07		8-04104	15.01	A	8-07108	15.09	D
8-03201	25.03		8-04115	15.02		8-07110	9.03	A
8-03202	25.03	A	8-04123	15.02	B	8-07111	15.08	E
8-03205	25.03	B	8-04124	15.02	C	8-07112	15.10	A
8-03206	25.03		8-04201	15.02	D	8-07113	15.10	C
8-03207	25.02	B	8-04202	15.04		8-07114	15.07	F
8-03208	25.02	C	8-04203	15.04	E	8-07114-A	15.07	D
8-03209	25.02	D	8-04205	15.05	A	8-07114-C	15.07	E
8-03210	25.02		8-04207	15.03	A	8-07114-I	15.08	B
8-03211	25.02	E	8-04210	15.04	C	8-07114-IC	15.08	A
8-03222	25.03	D	8-04216	15.06	A	8-07114-ICO	15.08	
8-03223	25.03		8-04219	15.06		8-07114-IS	15.08	
8-03224	25.03		8-04220	15.06		8-07114-ISO	15.08	C
8-03225	25.03		8-04221	15.06		8-07115	9.01	F
8-03230	25.03	E	8-04223	15.01	B	8-07116	15.09	F
8-03231	25.03		8-04224	15.05	B	8-07117	15.08	D
8-03236	25.02	A	8-04225	15.01	C	8-07121	9.01	E

30.03



ELEVATING THE QUALITY



1-800-263-3557

NUMERICAL INDEX

8-07122 >>> 8-13221

NUMBER	PAGE	PHOTO	NUMBER	PAGE	PHOTO	NUMBER	PAGE	PHOTO
8-07122	9.01		8-08160	26.07	E	8-11104	2.01	D
8-07123	9.01		8-08161	26.03	B	8-12101	4.01	B
8-07124	9.01	B	8-08162	26.05	C	8-12104	4.01	C
8-07125	9.01	C	8-08163	26.05	B	8-12105	4.01	A
8-07126	9.01	D	8-09106	12.02	D	8-12106	24.05	E
8-07127	9.01		8-09107	12.02		8-12107	24.06	B
8-07129	9.01	A	8-09108	12.02		8-12108	24.05	A
8-07130	9.01		8-09109	12.02	B	8-12108-5	24.05	B
8-07136	9.02	A	8-09110	12.01	D	8-12109	24.06	C
8-07137	9.03	D	8-09122	12.01	A	8-12110	4.01	D
8-07140	9.02	B	8-09123	12.01		8-12111	24.05	C
8-07148	15.06	C	8-09124	12.01		8-12111-5	24.05	D
8-07149	15.05	E	8-09125	12.01		8-12112	24.06	A
8-07150	15.06	D	8-09126	12.01		8-12113	24.06	E
8-07151	20.04	A	8-09127	12.01		8-12114	24.06	D
8-07152	20.04	B	8-09130	12.02	C	8-12115	4.01	E
8-07153	9.03	B	8-09132	12.02	A	8-13000	20.02	E
8-08101	26.04	C	8-09132-L	12.02		8-13002	20.01	C
8-08101-T	26.01	A	8-09133-A	12.01	B	8-13101	20.01	B
8-08102	26.04	B	8-09133-B	12.01	C	8-13102	20.01	
8-08102-T	26.01	B	8-10101	11.01	E	8-13103	20.05	D
8-08103	26.04		8-10102	11.01		8-13108	13.37	D
8-08104	26.04	D	8-10103	11.01		8-13109	13.37	
8-08104-T	26.01	C	8-10104	11.01		8-13110	13.37	C
8-08105	26.06	C	8-10105	11.01		8-13111	13.37	
8-08105-T	26.01	D	8-10106	11.01	F	8-13114	20.04	E
8-08106	26.06	B	8-10112	11.01	G	8-13115	20.04	
8-08107	26.05	D	8-10113	11.01		8-13116	20.04	
8-08108	26.05	E	8-10114	11.01		8-13117	20.04	
8-08109	26.06	A	8-10115	11.01		8-13124	20.04	C
8-08111	26.02	A	8-10123	11.01	A	8-13125	20.04	D
8-08112	26.02	F	8-10126	11.01	D	8-13126	14.03	
8-08114	26.02	E	8-10141	11.01	B	8-13127	14.03	C
8-08121	26.08	D	8-10142	11.01	C	8-13128	14.03	
8-08122	26.08		8-10249	28.01	A	8-13130	14.03	
8-08130	26.07	D	8-10250	28.01	B	8-13135	14.02	D
8-08134	26.05		8-10255	28.01		8-13139	20.02	A
8-08135	26.05	A	8-10260	28.01		8-13140	20.01	A
8-08136	26.04	A	8-10265	28.01		8-13141	20.01	
8-08138	26.06	D	8-10270	28.01	C	8-13146	13.01	
8-08139	26.06		8-10272	28.01		8-13147	13.01	
8-08143	26.02	B	8-10275	28.01		8-13200	20.03	A
8-08145	26.02	C	8-10276	28.01		8-13205	20.03	B
8-08146	26.07	B	8-10277	28.01		8-13210	20.03	C
8-08146-A	26.07	A	8-10280	28.01	D	8-13211	20.03	D
8-08147	26.02	D	8-10282	28.01		8-13212	14.03	B
8-08148	26.03	A	8-10283	28.01		8-13212-L	14.03	
8-08149	26.03	C	8-10285	28.01		8-13213	14.03	A
8-08152	26.03	C	8-10287	28.01		8-13214	20.05	
8-08153	26.08	B	8-10290	28.01	E	8-13215	20.05	C
8-08154	26.04	F	8-10295	28.01		8-13215-D	20.05	B
8-08155	26.04	E	8-10297	28.01		8-13216	14.02	E
8-08156	26.07	C	8-10298	28.01	F	8-13217	14.02	
8-08157	26.06	G	8-10299	28.01		8-13218	20.05	A
8-08157-A	26.06	F	8-11101	2.01	A	8-13219	13.01	B
8-08158	26.08		8-11102	2.01	B	8-13220	13.01	
8-08158-A	26.08	A	8-11103	2.01	C	8-13221	13.01	A



NUMERICAL INDEX

8-13222 >>> 8-15242

NUMBER	PAGE	PHOTO	NUMBER	PAGE	PHOTO	NUMBER	PAGE	PHOTO
8-13222	13.01		8-14522-S	19.01	B	8-14560	19.01	A
8-13223	20.01	D	8-14523	19.01	D	8-14561	7.05	B
8-13224	20.04		8-14524	19.01	E	8-14562-L	7.01	
8-13225	20.01	E	8-14525	19.01	F	8-14562-R	7.01	A
8-13226	20.01		8-14526	7.05	A	8-15100	24.10	B
8-14200-L	19.02		8-14526-L	7.05		8-15101	24.10	
8-14200-S	19.02		8-14527	7.04	C	8-15102	24.10	
8-14201-L	19.02		8-14527-L	7.04		8-15103	24.10	
8-14201-S	19.02		8-14528	7.07	C	8-15104	24.10	
8-14202-L	19.02	B	8-14528-L	7.05	D	8-15105	24.10	
8-14202-R	19.02	C	8-14528-R	7.05	E	8-15106	24.10	
8-14204-L	19.02		8-14530	7.02	E	8-15107	24.10	
8-14204-R	19.02	D	8-14530-I	8.01		8-15108	24.10	
8-14205-L	19.02	E	8-14530-L	7.02		8-15115	24.10	A
8-14205-R	19.02		8-14530-LI	8.01	F	8-15116	24.10	
8-14401	19.02		8-14531	7.06	B	8-15117	24.10	
8-14402	19.02		8-14531-L	7.06		8-15118	24.10	
8-14403	19.02	A	8-14532	7.06	C	8-15119	24.10	
8-14404	19.02		8-14532-L	7.06		8-15120	24.10	
8-14405	19.02	B	8-14533-L	7.03		8-15121	24.10	
8-14406	19.02		8-14533-R	7.03	A	8-15122	24.10	
8-14502	7.02	D	8-14535-L	7.04		8-15123	24.10	
8-14502-I	8.01		8-14535-LI	8.03		8-15124	24.10	
8-14502-L	7.02		8-14535-R	7.04	B	8-15125	24.10	
8-14502-LI	8.01	D	8-14535-RI	8.03	A	8-15126	24.10	
8-14503-L	7.01	C	8-14536-L	7.07		8-15127	24.10	
8-14503-R	7.01		8-14536-R	7.07	A	8-15128	24.10	
8-14504	7.04	D	8-14537-L	7.06		8-15130	24.04	
8-14505	7.01	B	8-14537-R	7.06	A	8-15131	24.04	
8-14506	7.03	D	8-14539	7.05	C	8-15132	24.04	
8-14506-I	8.02	A	8-14539-I	8.03	F	8-15133	24.04	
8-14507	7.04	E	8-14540	16.01	A	8-15134	24.04	A
8-14507-I	8.03	D	8-14541	15.07	B	8-15140	24.03	B
8-14508	7.02	C	8-14541-0	15.07	C	8-15141	24.03	C
8-14508-L	7.02		8-14542	8.01	A	8-15142	24.03	D
8-14509	7.03	C	8-14543	8.01		8-15143	24.03	E
8-14511	7.01	D	8-14544	16.01	D	8-15144	24.03	F
8-14512	7.02	A	8-14545	16.01	E	8-15145	24.07	D
8-14512-L	7.02		8-14546	8.01	E	8-15200	24.07	B
8-14513	19.01	C	8-14547	8.03	E	8-15201	24.07	A
8-14514	19.01		8-14548	8.01	E	8-15215	24.01	A
8-14515	19.01		8-14549	8.01	B	8-15216	24.01	
8-14516	7.04	A	8-14550	16.01	B	8-15217	14.01	D
8-14516-I	8.02	G	8-14551	16.01	C	8-15218	14.02	A
8-14516-L	7.04		8-14552	16.01	F	8-15219	14.01	A
8-14516-LI	8.02		8-14553-L	8.03		8-15220	14.01	B
8-14516-S	7.04		8-14553-R	8.03	B	8-15221	14.02	C
8-14516-SL	7.04		8-14554-L	8.02		8-15222	14.02	
8-14517	7.07	B	8-14554-R	8.02	B	8-15223	14.01	C
8-14518	19.03	A	8-14555-L	8.03		8-15224	14.02	
8-14518-L	19.03		8-14555-R	8.03	C	8-15225	24.04	
8-14519	19.03	B	8-14556	8.02	C	8-15226	24.04	A
8-14519-L	19.03		8-14557	8.01	C	8-15227	24.04	
8-14520	19.03	C	8-14558	7.03	F	8-15228	24.04	
8-14520-L	19.03		8-14558-I	8.02	F	8-15240	24.04	
8-14521	7.03	E	8-14559	7.03	G	8-15241	24.04	
8-14522	19.01		8-14559-I	8.02	D	8-15242	24.04	

30.05



ELEVATING THE QUALITY



1-800-263-3557

NUMERICAL INDEX

8-15243 >>> 91-7112

NUMBER	PAGE	PHOTO	NUMBER	PAGE	PHOTO	NUMBER	PAGE	PHOTO
8-15243	24.04		8-17011	18.02		91-7043	5.05	
8-15244	24.04		8-17013	18.02	D	91-7044	5.05	A
8-15245	24.04		8-17014	18.02		91-7045	5.02	F
8-15246	24.04	C	8-17015	18.02	E	91-7046	5.05	B
8-15247	14.02	B	8-17016	18.02		91-7047	5.02	E
8-15248	24.08	A	8-17017	18.03	A	91-7050	5.05	C
8-15249	24.08	B	8-17018	18.03	B	91-7051	5.05	
8-15250	24.08	C	8-17019	18.03	C	91-7052	5.05	D
8-15251	24.08	D	8-17020	18.03	D	91-7053	5.05	
8-15252	24.08	E	8-17021	18.01	A	91-7055	5.08	F
8-15253	24.07	C	8-17022	18.01	B	91-7057	5.17	C
8-15254	24.07	E	8-17023	18.01	C	91-7058	5.04	
8-15255	14.03	D	8-17024	18.01	D	91-7060	5.08	G
8-15256	24.09		8-17100	17.01	B	91-7061	5.04	
8-15257	24.09		85-2001	23.01	A	91-7062	5.04	
8-15258	24.09		85-2002	23.01		91-7063	5.08	
8-16141	22.09	A	85-2003	23.01		91-7064	5.08	D
8-16142	22.08	A	85-2004	23.01		91-7065	5.09	B
8-16143	22.04	A	85-2005	23.01	C	91-7066	5.09	
8-16144	22.05	A	85-2006	23.01		91-7066-S	5.09	E
8-16145	22.04	D	85-5018	13.36		91-7067	5.04	D
8-16146	22.06	B	85-5019	13.36	E	91-7068	5.04	
8-16147	22.05	E	85-5023	13.36	C	91-7069	5.04	E
8-16148	22.09	C	85-5024	13.36	A	91-7070	5.09	F
8-16149	22.01	A	85-5025	13.36	D	91-7071	5.08	C
8-16150	22.05	B	85-5026	13.36	B	91-7072	5.08	
8-16151	22.04	B	85-9001	20.02		91-7075	5.09	
8-16152	22.01	E	85-9002	20.02	B	91-7076	5.09	C
8-16153	22.04		85-9004	20.02	C	91-7078	5.16	A
8-16154	22.04	C	91-1000	5.01	F	91-7079	5.16	B
8-16156	22.05	D	91-1001	5.01	E	91-7080	5.16	D
8-16157	22.02	B	91-1002	5.01	G	91-7085	5.16	
8-16158	22.07	A	91-1100	5.01		91-7086	5.16	
8-16159	22.09	B	91-1101	5.01		91-7087	5.16	
8-16160	22.05	C	91-1105	5.01	C	91-7088	5.16	
8-16161	22.01	B	91-2000	5.14	A	91-7089	5.16	C
8-16162	22.01	D	91-2100	5.02	C	91-7090	5.04	A
8-16163	22.01	C	91-2101	5.02		91-7091	5.03	F
8-16164	22.08	C	91-2102	5.02		91-7092	5.03	E
8-16165	22.06	D	91-2103	5.02	B	91-7093	5.04	B
8-16166	22.07	B	91-2105	5.02	A	91-7093-R	5.04	C
8-16167	22.07	C	91-7024	5.01	A	91-7094	5.03	B
8-16168	22.07	D	91-7025	5.01		91-7095	5.14	E
8-16169	22.08	B	91-7026	5.01		91-7096	5.03	G
8-16170	22.02	D	91-7027	5.01		91-7097	5.02	D
8-16171	22.06	A	91-7030	5.01		91-7098	5.02	
8-16172	22.03	C	91-7031	5.14	B	91-7099	5.02	
8-16173	22.03	B	91-7032	5.15	D	91-7100	5.14	F
8-16174	22.02	E	91-7033	5.15	A	91-7101	5.03	A
8-16175	22.06	C	91-7035	5.01	D	91-7101-S	5.03	
8-16176	22.03	A	91-7036	5.08	B	91-7102	5.15	E
8-17005	18.02		91-7037	5.02		91-7103	5.02	
8-17006	18.02	A	91-7038	5.02		91-7105	5.03	C
8-17007	18.02		91-7039	5.02		91-7106	5.03	
8-17008	18.02	B	91-7040	5.02		91-7110	5.04	F
8-17009	18.02	C	91-7041	5.04	G	91-7111	5.04	
8-17010	18.02		91-7042	5.04		91-7112	5.04	



NUMERICAL INDEX

91-7114 >>> 99-IH90406

NUMBER	PAGE	PHOTO	NUMBER	PAGE	PHOTO
91-7114	5.04		91-8027-V	5.13	
91-7115	5.10	D	91-8028	5.11	E
91-7116	5.10		91-8029-L	5.15	
91-7117	5.10	E	91-8029-R	5.15	C
91-7122	5.10	D	91-8030	5.12	B
91-7123	5.10		91-8031	5.12	F
91-7127	5.01	B	91-8032	5.07	G
91-7128	5.01		91-8032-L	5.08	A
91-7129	5.06	A	91-8033	5.11	C
91-7130	5.06		91-8034	5.10	C
91-7131	5.06		91-8036	5.12	C
91-7132-A	5.06		92M3H	2.01	E
91-7132-S	5.06	D	92M3HL	2.01	
91-7133	5.06		92M3K	2.01	F
91-7133-A	5.06	B	92M3KL	2.01	
91-7134-A	5.06	C	92M3KM	2.01	G
91-7134-S	5.06		99-IH90100	16.02	A
91-7135-A	5.06		99-IH90100-R	16.02	B
91-7135-S	5.06		99-IH90110	16.02	C
91-7136-A	5.06		99-IH90301	16.02	D
91-7136-S	5.06		99-IH90301.2	16.02	
91-7137	5.06		99-IH90301.5	16.02	
91-7138	5.07	A	99-IH90302	16.02	E
91-7140	5.14	D	99-IH90302.4	16.02	
91-7141	5.07	B	99-IH90302.5	16.02	
91-7142	5.07		99-IH90303	16.03	A
91-7143	5.09	A	99-IH90303.5	16.03	
91-7144	5.08	E	99-IH90304	16.03	B
91-7145	5.10	A	99-IH90304.5	16.03	
91-7146	5.10	B	99-IH90306	16.03	C
91-7146-L	5.10		99-IH90306.4	16.03	
91-7202	5.12	G	99-IH90306.5	16.03	
91-7204	5.13	A	99-IH90307	16.03	D
91-7205	5.14	C	99-IH90308	16.03	E
91-7206	5.07	C	99-IH90309	16.03	F
91-8002	5.03		99-IH90311	16.04	A
91-8003	5.03		99-IH90311.5	16.04	
91-8004	5.03		99-IH90312	16.04	B
91-8005	5.03		99-IH90313	16.04	C
91-8006	5.03	D	99-IH90314	16.04	
91-8007	5.03		99-IH90331	16.04	D
91-8011	5.07	D	99-IH90337	16.04	E
91-8012	5.07	E	99-IH90400	16.05	A
91-8013	5.15	B	99-IH90401	16.05	B
91-8014	5.13	D	99-IH90402	16.05	C
91-8015	5.12	E	99-IH90403	16.05	D
91-8016	5.07	F	99-IH90404	16.05	E
91-8018	5.11	A	99-IH90405	16.05	F
91-8019	5.11	B	99-IH90406	16.05	G
91-8020	5.11	D			
91-8021	5.11				
91-8022	5.11	F			
91-8023	5.12	A			
91-8024	5.12	D			
91-8025	5.13	B			
91-8026	5.13	E			
91-8027	5.13	F			

30.07



ALPHABETICAL INDEX

Aker >>> Brown

31.00

Description	Page	Photo
A		
Aker Lens Pusher, Round Handle	15.02	D
Alger Brush	20.01	A
Anis Curved w/Lock X-Delicate, Stainless	21.01	
Anis Curved w/o Lock X-Delicate, Stainless	21.01	
Anis Straight w/Lock X-Delicate, Stainless	21.01	
Anis Straight w/o Lock X-Delicate, Stainless	21.01	A
Anis Tying Forceps, Curved, Round Handle	13.38	
Anis Tying Forceps, Straight, Round Handle	13.38	A
Applanation	22.01	
Arruga Capsule Forceps, Standard	13.01	C
Arruga, New Curve, Wide Handle	13.01	
AutoClaves		

Description	Page	Photo
B		
Banaji Double-Ended LASIK Spatula	22.08	A
Banaji LASIK Irrigation Cannula, 25g	5.12	A
Banaji LASIK Marker	22.04	A
Bansal LASIK Irrigation Cannula, 25g	5.12	B
Barraquer Aspiration Speculum, Adult...	26.04	A
Barraquer Blade Breaker & Holder	2.01	A
Barraquer Cilia Forceps	13.10	A
Barraquer Cyclodialysis Spatula...	9.01	A
Barraquer Delicate, Curved w/Lock...	21.01	
Barraquer Delicate, Curved w/o Lock...	21.01	
Barraquer Delicate, Curved w/o Lock...	21.01	B
Barraquer Delicate, Straight w/Lock...	21.01	
Barraquer Delicate, Straight w/o Lock...	21.01	
Barraquer Heavy Wire Speculum...	26.04	
Barraquer Iris Scissors, Blunt...	25.04	F
Barraquer Iris Spatula...	9.01	
Barraquer Scissors, Angled Small Blades...	25.02	
Barraquer Scissors, Angled Small Blades...	25.02	A
Barraquer Standard, Curved w/Lock...	21.01	C
Barraquer Standard, Curved w/o Lock...	21.01	
Barraquer Standard, Straight w/Lock...	21.01	
Barraquer Standard, Straight w/o Lock...	21.01	
Barraquer Wire Speculum, Large Blades, N...	26.01	B
Barraquer Wire Speculum, Large Blades, T...	26.04	B
Barraquer Wire Speculum, Large Solid Blades, N...	26.01	C
Barraquer Wire Speculum, Small Blades, T...	26.04	C
Barraquer Wire Speculum, Small Blades...	26.01	A
Barraquer Wire Speculum, w/Large Solid Blades, T...	26.04	D
Barraquer, Delicate, Curved w/Lock...	21.01	
Battle ICL Manipulator-Titanium	15.03	B
Bechert Dual Port Irrigating "Y" Manipulator	15.07	B
Bechert Lens Pusher 45, Angled	15.03	A
Bechert Nucleus Rotator, Angled	15.07	A
Bechert Nucleus Rotator, Angled, 7mm-Titanium	15.07	
Bechert Open Ended Irrigating "Y" Manipulator	15.07	C
Bechert/McPherson Tying Forceps Angled...	13.38	B
Behler LASIK Retreatment Hook	22.07	A
Bennett Cilia Forceps, 3mm Cup Jaws	13.10	B
Berke Ptosis Forceps, 20mm Blades w/Lock	13.08	A
Berke Ptosis Forceps, 27mm Blades w/Lock	13.08	

Description	Page	Photo
Bi-Manual Irrigation Handpieces	16.01	
Binkhorst 180 Degree I&A Tip w/0.3mm Port	16.03	C
Binkhorst 180 Degree I/A Tip w/0.4mm Port	16.03	
Binkhorst 180 Degree I/A Tip w/0.5mm Port	16.03	
Binkhorst Cannula 22g Left, 18mm Length	5.04	E
Binkhorst Cannula 22g Right, 18mm Length	5.04	
Binkhorst-McIntyre, 26g, Cannula, 18mm Left	5.04	
Binkhorst-McIntyre, 26g, Cannula, 18mm Right	5.04	
Binkhorst-McIntyre, 26g, Cannula...	5.04	D
Bishop-Harmon Adapter For Squeeze Bulb	5.01	
Bishop-Harmon Cannula, 19g, 7mm Tip, 24mm	5.01	D
Bishop-Harmon Cannula, w/Bulb & Adapter	5.01	C
Bishop-Harmon, Cross Serrations	13.11	B
Bishop-Harmon, Delicate, 1x2 Teeth	13.11	
Bishop-Harmon, X-Delicate, 1x2 Teeth	13.11	A
Blaydes Lens Insertion Forceps	13.27	
Blaydes Lens Insertion Forceps-Titanium	13.27	A
Bohigian 19g Tip, 16g Sleeve Anterior Chamber...	16.01	F
Bonaccolto Utility, 1.2mm Jaws	13.11	C
Bonaccolto Utility, 1.7mm Jaws	13.11	
Bonn Iris Hook, Angled	15.01	A
Bonn Iris Micro Hook, Straight-Titanium	15.01	
Bonn Long Forceps, .12mm 1x2 Teeth...	13.11	D
Bonn Micro Iris Hook, Straight	15.01	
Bonn Miniature, Curved 3-1/2" w/15mm Blades	25.04	A
Bonn Miniature, Straight 3-1/2" w/15mm Blades	25.04	
Bonn Short Forceps, .12mm 1x2 Teeth...	13.11	
Bonn, Curved, 1x2 Teeth, .12mm, w/Platform...	13.18	
Bonn, Straight, 1x2 Teeth, .12mm, w/Platform...	13.18	
Bonn, Straight, 1x2 Teeth, .12mm, w/Platform...	13.18	A
Bores Axis Marker	24.07	A
Bores Fixation Forceps, 1x2, .12mm Straight	13.11	E
Bores Radial Marker, 6 Blades	24.08	A
Bores Radial Marker, 8 Blades	24.08	
Bowman Lacrimal Probe Size 0000-000	12.01	A
Bowman Lacrimal Probe Size 00-0	12.01	
Bowman Lacrimal Probe Size 1-2	12.01	
Bowman Lacrimal Probe Size 3-4	12.01	
Bowman Lacrimal Probe Size 5-6	12.01	
Bowman Lacrimal Probe Size 7-8	12.01	
Bracken Fixation Forceps, 1x2 Teeth	13.12	B
Brems LASIK Marker w/Level	22.04	B
Brown Capsule Polisher, 26g	5.03	A
Brown Capsule Polisher, 26g, w/Sand Blasted Tip	5.03	
Brown Glaucoma Tube Forceps	13.34	C
Brown ICL Suction Manipulator	22.06	C
Brown INTACS Insertion Forceps-Titanium	17.01	A
Brown INTACS Pocket Starter-Stainless	17.01	B
Brown LASEK Butterfly Trephine, 9.5mm	18.01	A
Brown LASEK Epithelial Repositioning Cannula	5.11	C
Brown LASEK Micro Plow	18.01	D
Brown LASEK Nested Trephine Well, 9.5mm	18.01	C
Brown LASEK Nested Trephine...	18.01	B
Brown LRI Guide...	24.07	C
Brown Pupil Dilator, Phaco Incision	12.01	B
Brown Side Port Pupil Dilator	12.01	C
Brown Silicone Lens Cutter, Straight	19.01	A



ELEVATING THE QUALITY OF CARE IN OPHTHALMOLOGY
800-637-4346



ALPHABETICAL INDEX

Brown >>> Connor

Description	Page	Photo
Brown-Grabow Capsulorrhexis Cystotome...	13.05	A
Bunge Evisceration Spoon, Large 11mm Cup	20.01	
Bunge Evisceration Spoon, Small 8mm Cup	20.01	B
Burrato LASIK Irrigation Cannula, 25g	5.11	D

C

Calipers, Rulers & Gauges	4.03	
Cannula Handles	5.01	
Cannula, J-Shaped	5.04, 5.06, 5.07, 6.02	
Cannulas, Air Injection/ Irrigation	5.02	
Cannulas, Alpha-Chymotrypsin	5.02	
Cannulas, Anterior Chamber	6.02	
Cannulas, Capsule Polishers	5.03-5.04	
Cannulas, Cortex Extraction	5.04-5.05	
Cannulas, Cyclodialysis	5.05	
Cannulas, Cystotomes	6.02	
Cannulas, Hydrodissection	5.06-5.09, 6.02	
Cannulas, I&A	5.09	
Cannulas, Irrigating Choppers	5.11	
Cannulas, Irrigating Vectis	5.10	
Cannulas, Lachrymal	5.11	
Cannulas, LASIK & LASEK	5.12-5.15	
Cannulas, Miscellaneous	5.16-5.17	
Cannulas, Peribulbar	5.18, 6.01	
Cannulas, Retrobulbar	5.18, 6.01, Guide 20.01	
Cannulas, Sub-Tenon	5.18	
Capsule Polishers	20.05	
Carpel Aspirating Speculum, Temporal Fit	26.04	E
Carpel Non-Aspirating Speculum, Temporal Fit	26.04	F
Carpel One-Step Trabeculectomy Punch	20.01	C
Casebeer Capsulorrhexis Forceps	13.05	B
Castillejos LASIK Retreatment Spatula	22.08	B
Castroviejo 5-1/2", Curved w/Lock, Stainless	21.02	
Castroviejo 5-1/2", Curved w/o Lock, Stainless	21.02	
Castroviejo 5-1/2", Straight w/Lock, Stainless	21.02	
Castroviejo 5-1/2", Straight w/o Lock, Stainless	21.02	A
Castroviejo Blade Breaker & Holder	2.01	B
Castroviejo Caliper, Straight	4.01	B
Castroviejo Colibri, .12mm	13.12	C
Castroviejo Corneal Section, Curved...	25.02	B
Castroviejo Corneal Section, Curved...	25.02	C
Castroviejo Corneal, Curved Blunt Tips, Small	25.02	D
Castroviejo Cyclodialysis Spatula, 10mm x 1mm	9.01	C
Castroviejo Cyclodialysis Spatula, 15mm x 1mm	9.01	D
Castroviejo Cyclodialysis, 10&15mm x .5mm Wide	9.01	B
Castroviejo Cyclodialysis, 10&15mm x .75mm Wide	9.01	
Castroviejo Cyclodialysis, 10&15mm x 1mm Wide	9.01	
Castroviejo Delicate, Curved w/Lock, Stainless	21.02	B
Castroviejo Delicate, Curved w/o Lock, Stainless	21.02	
Castroviejo Delicate, Straight w/Lock, Stainless	21.01	
Castroviejo Delicate, Straight w/o Lock, Stainless	21.02	
Castroviejo Double Ended Spatula, .25mm	9.01	
Castroviejo Keratoplasty Scissors, Blunt Points	25.02	E
Castroviejo Keratoplasty Scissors, Sharp Points	25.02	
Castroviejo Lacrimal Dilator Double-Ended	12.01	D
Castroviejo Scissors Micro, Left	25.03	A

Description	Page	Photo
Castroviejo Scissors Micro, Right	25.03	
Castroviejo Scissors, Standard, Left	25.03	
Castroviejo Scissors, Standard, Right	25.03	B
Castroviejo, .12mm, Angled	13.12	D
Castroviejo, .12mm, Straight	13.12	E
Castroviejo, .12mm, Wide Handle, Straight	13.12	F
Castroviejo, .3mm, Angled	13.12	
Castroviejo, .3mm, Straight	13.12	
Castroviejo, .3mm, Wide Handle, Straight	13.12	
Castroviejo, .5mm, Angled	13.12	
Castroviejo, .5mm, Straight	13.12	
Castroviejo, .5mm, Wide Handle, Straight	13.12	
Castroviejo, .6mm, Wide Handle, Straight	13.12	
Castroviejo, .9mm, Wide Handle, Straight	13.12	
Castroviejo, Double Ended, .35mm Angled...	9.01	E
Castroviejo, Straight, 1x2 Teeth...	13.18	B
Castroviejo, Straight, 1x2 Teeth...	13.18	
Cautery Cleaning Pads 10/Box (Non-Sterile)	20.03	D
Cautery Pens	20.03	
Cellulose Eye Spears, 100/Box	6.03	A
Chang 20g Irrigating Chopper, Right Curve	5.10	C
Chang 27g Hydrodissection Cannula, Long 90 Degree ...	5.08	A
Chang 27g Hydrodissection Cannula, Short 90 Degree...	5.07	G
Chang Chopper, 1.75mm Tip, Double Ended...Left...	7.01	
Chang Chopper, 1.75mm Tip, Double Ended...Right...	7.01	A
Choppers Non Irrigating Double Ended	7.06-7.07	
Choppers Non Irrigating Stainless & Titanium	7.01-7.06	
Choppers, Irrigating	8.01-8.03	
Chu Foldable Lens Cutter, Angled	19.01	
Chu Foldable Lens Cutter, Straight	19.01	B
Chu ICL Manipulator-Titanium	15.03	C
Clayman Lens Forceps w/Lock	13.27	
Clayman Lens Forceps w/o Lock	13.27	B
Clayman Lens Insertion Forceps-Titanium	13.27	C
Clayman Lens Rotator, .5mm Wide, V/Notch	15.03	D
Cleaning Blocks	6.03	
Colibri Forceps .12mm, 1x2 Teeth	13.13	A
Colibri Utility, .12mm, X-Delicate	13.13	B
Colibri w/Tying Platform, .3mm	13.13	C
Colibri, .12mm Teeth, w/Platform, 3-3/8"-Titanium	13.18	C
Colibri, .12mm Teeth, w/Platform, 4"-Titanium	13.18	
Colibri, Pierce Teeth, w/Platform, 3-3/8"-Titanium	13.18	D
Colibri, Troutman/Barraquer, .12 Teeth...	13.18	E
Collamer & ICL Cartridge Loading Block	13.31	B
Complete Cassette For Statim 2000	1.01	B
Complete Cassette For Statim 5000	1.01	E
Connor Capsulorrhexis Peeler Forceps	13.05	C
Connor Wand -Straight, Titanium	15.07	
Connor Wand, Angled	15.07	D
Connor Wand, Angled-Titanium	15.07	
Connor Wand, Curved	15.07	E
Connor Wand, Curved w/Open-Ended...	15.08	
Connor Wand, Curved w/Right & Left 20g...	15.08	A
Connor Wand, Curved-Titanium	15.07	
Connor Wand, Straight	15.07	F
Connor Wand, Straight w/Distal Irrigation...	15.08	B
Connor Wand, Straight w/Open-Ended Irri...	15.08	C

31.01



ELEVATING THE QUALITY



1-800-263-3557

ALPHABETICAL INDEX

Connor >>> Fine

31.02

Description	Page	Photo	Description	Page	Photo
Connor Wand, Straight w/Right & Left 20g Irri...	15.08		Diamond Knife, CVD	10.06	A
Cook 1-7/8", Child Size, 11mm Blades, T...	26.05	A	Diamond Knives Cleaning System	10.07	
Cook 1-7/8", Infant Size, 9mm Blades, T...	26.05		Diamond Knives Plastic Surgery	10.06	
Corydon Viscoelastic Irrigating Cannula 25g, 7/8"	5.14	B	Diamond Knives Titanium Cataract	10.01,10.02	
Crescent 1.4mm CVD Diamond	10.03	D	Diamond Knives Titanium Refractive & LRI	10.05	
Crescent Blades, 2.0mm Angled, Bevel Down...	3.02	C	Diamond Knives, Miscellaneous /CVD	10.03	
Crescent Blades, 2.0mm Angled, Bevel Up...	3.02	B	Diamond Knives, Miscellaneous /Sapphire	10.04	
Crescent Blades, 2.0mm Angled, Double Bevel...	3.02	D	Dilators	12.01-12.02	
Culler Iris Spatula, 1mm x 30mm	9.01	F	Dishler LASIK Irrigation Cannula, 30g, 7mm	5.12	
Currettes	15.11		Dishler LASIK Irrigation Cannula, 30g, 9mm	5.12	E
Curved 20g Aspiration w/Handpiece w/Capsule...	16.01	E	Disposable Steril Products	6.03	
Curved 20g Aspiration w/Handpiece w/Capsule...	16.01	D	Double Ended Synechia Spatula	9.02	A
Curved 20g Dual Port Irrigation w/Handpiece...	16.01	B	Double Stack Tray, 6" x 10" x 1.5"	27.02	B
Curved Bi-Manual Aspiration Handpiece, .3mm...	16.05	E	Double Stack Tray, 7" x 11"	27.02	C
Curved Bi-Manual Aspiration Handpiece,21g	16.05	D	Double Sterilization Tray, 11" x 14"	27.01	D
Curved Bi-Manual Aspiration Handpiece,23g	16.05	B	Double Sterilization Tray, 6" x 9"	27.01	C
Curved Bi-Manual Irrigation Handpiece, 5mm, 21g	16.05	G	Double Sterilization Tray, 8" x 13"	27.01	
Curved I&A Tip w/0.3mm Aspiration Port	16.02	E	Douglas Cilia Forceps, 2.5mm	13.10	C
Curved I/A Tip w/0.4mm Aspiration Port	16.02		Dressing Forceps Delicate, Curved	13.20	
Curved I/A Tip w/0.5mm Aspiration Port	16.02		Dressing Forceps Delicate, Straight	13.20	A
Curved Silicone Sleeve I/A Tip w/0.3mm Port	16.04	A	Dressing Forceps Standard, Curved	13.20	
Curved Silicone Sleeve I/A Tip w/0.5mm Port	16.04		Dressing Forceps Standard, Straight	13.20	B
Curved, 3-3/8"-Titanium	13.41	A	Dreus Capsule Polisher, 25g, Port At 6 O'Clock	5.03	D
Curved, 4"-Titanium	13.41	B	Drysdale Nucleus Manipulator	15.08	B
Curved, w Lock, Standard Jaws, 4-1/4" - Titanium	21.03		Dusek-McIntyre Forceps	13.30	C
Curved, w/Lock, Delicate Jaws, 4-1/4" - Titanium	21.03				
Curved, w/Lock, Delicate Jaws, 5-1/2" - Titanium	21.03		E		
Curved, w/Lock, Standard Jaws, 5-1/2" - Titanium	21.03	A	Ehrhardt Lid Forceps, Serrated Jaw 9.5mm	13.08	C
Curved, w/o Lock, Delicate Jaws, 4-1/4" - Titanium	21.03		Elschnig, 1x2 Teeth, Straight	13.14	F
Curved, w/o Lock, Delicate Jaws, 5-1/2" - Titanium	21.03	B	Enucleation Scissors 5", Full Curve	25.05	
Curved, w/o Lock, Standard Jaws, 4-1/4" - Titanium	21.03	C	Enucleation Scissors 5", Light Curve	25.05	A
Curved, w/o Lock, Standard Jaws, 5-1/2" - Titanium	21.03		Enucleation Scissors 5", Medium Curve	25.05	
			Eye Sheild	20.02	
			Eye Spears	6.03	
			Eye Spears	6.03	
			F		
			Faulkner Lens Holder	13.32	A
			Faulkner Lens Insertion Forceps X-Action	13.27	D
			Feaster A/K Micrometer Knife-Titanium	10.05	F
			Feaster Speculum, Open Wire Blades	26.05	B
			Feaster Speculum, Solid Blades	26.05	C
			Feaster Spherical Spatula, w/Malleable Tip	9.02	B
			Feaster Titanium R/K Micrometer Knife	10.05	E
			Fenzl Lens Hook, .15mm Angled	15.04	
			Fenzl Lens Hook, .15mm, Straight w/Guard	15.04	A
			Fenzl Lens Manipulator, Angled-Titanium	15.04	B
			Fenzl Lens Manipulator, Straight-Titanium	15.04	
			Fine 20g Irrigating Capsulorrhesis Forceps...	13.01	D
			Fine 20g Irrigating Reverse Actuating Splitting...	8.01	A
			Fine 21g Bi-Manual Irrigation Handpiece, Curved...	16.05	F
			Fine 22g Irrigating Capsulorrhesis Forceps...	13.01	
			Fine 22g Irrigating Reverse Actuating Splitting...	8.01	
			Fine Collamer & ICL Lens Loading Forceps	13.31	A
			Fine Collamer & ICL Lens Loading Forceps...	13.21	A

D

Davidoff Ambidextrous Nucleus Chopper	7.01	B
Davidoff Ambidextrous Nucleus Chopper-Titanium	7.01	
Davis Irrigating Iris Retractor	5.14	C
Dell Astigmatism Marker, 40, 60, & 80 Degrees...	24.05	C
Dell Astigmatism Marker, 40, 60, & 80 Degrees...	24.05	D
Dell Astigmatism Marker, 6mm & 8mm Cord...	24.05	A
Dell Astigmatism Marker, 6mm & 8mm Cord...	24.05	B
Delron Irrigating Handle, Male/Female Fittings	5.01	E
Delron Irrigating Handle, Male/Female Fittings	5.01	
Delron Irrigating Handle, Two Male...	5.01	F
Desmarres Forceps, Large 17x28mm	13.08	B
Desmarres Forceps, Medium 12x23mm	13.08	
Desmarres Forceps, Small 11x17mm	13.08	
Desmarres Lid Retractor 5-1/2", Size 1, 11mm	23.01	A
Desmarres Lid Retractor 5-1/2", Size 2, 13mm	23.01	
Desmarres Lid Retractor 5-1/2", Size 3, 15mm	23.01	
Desmarres Lid Retractor 5-1/2", Size 4, 17mm	23.01	
Diamond Knife Cleaning Blocks	6.03	
Diamond Knife Cleaning Blocks, 10/Box	6.03	C
Diamond Knife Tray, Double Slots	27.01	A
Diamond Knife Tray, Single Slot, 2" x 6"	27.02	
Diamond Knife Tray, Triple Slots	27.01	



ELEVATING THE QUALITY OF CARE IN OPHTHALMOLOGY
800-637-4346



ALPHABETICAL INDEX

Fine >>> Graether

Description	Page	Photo	Description	Page	Photo
Fine Collamer & ICL Loading Platform...	13.21		Formed Ultrata/Kershner Capsulorrhexis Cyst...	13.06	A
Fine Collamer & ICL Loading Platform...	13.21	B	Francis Chalazion Forceps, 12x14mm	13.09	A
Fine Crescent Fixation Ring w/Swivel Handle...	14.02		Frederick-Kuglen Hook For Posterior Segment	15.01	C
Fine Crescent Fixation Ring...	14.02	B	Frederick-Sinsky Hook For Posterior Segment	15.01	B
Fine Foldable Lens Insertion Forceps	13.28	A	Freehand 45 Degree Sapphire 1mm Knife, Straight	10.04	E
Fine Foldable Lens Loading Block-Stainless	13.21	C	Freehand Spear Sapphire 1mm Knife, Straight	10.04	F
Fine Head-Tilt Capsulorrhexis Cystotome Forceps...	13.05	D	Freehand Tri-Facet Sapphire 1mm Knife, Straight	10.04	G
Fine I Inserter Straight w/Lock-Titanium	13.21		G		
Fine I Inserter Straight-Titanium	13.21	D	Gaskin Fragment Forceps	13.33	A
Fine II Inserter, Angled-Titanium	13.21		Gaskin, Angled, 11mm, 3-3/8"-Titanium	13.41	C
Fine II Inserter, Angled w/Lock-Titanium	13.21	E	Gass Retinal Detachment Hook, Flattened...	20.01	D
Fine II Inserter, Straight w/Lock-Titanium	13.21		Gass Scleral Marker, 2.0mm Diameter Marking...	20.01	
Fine III Inserter, Angled w/Lock-Titanium	13.24	F	Geggel Corneal Chiller For PRK & LASEK	22.06	B
Fine III Inserter, Angled w/o Lock-Titanium	13.24		Geggel Corneal Transplant Marker, 16 Bite...	24.06	A
Fine Lens Loading Forceps-Titanium	13.21	F	Geggel Corneal Transplant Marker, 24 Bite...	24.06	B
Fine Scleral Marker	24.05	E	Gill (Chandler) Serrated Tip	13.13	D
Fine Stitch Scissors, Curved Sharp Tips	25.06		Gill Knife, Slightly Curved 3.5mm Blade	11.01	A
Fine Stitch Scissors, Straight Sharp Tips	25.06	A	Gill, 1x2 Teeth, Curved	13.13	E
Fine Wedge 20g Irrigating Chopper w/Open Ended...	8.01	B	Gills I&A, 25g Aspirating & 23g Irrigating	5.08	B
Fine/Thornton 13mm Ring w/Fixed Handle	14.02	C	Gills I&A, 25g Thin Wall/Aspiration, 23g Thin Wall...	5.08	
Fine/Thornton 13mm Ring w/Swivel Handle	14.02		Gills/Vannas Scissors, 10mm, Curved	25.01	
Fine/Thornton 16mm Ring w/Fixed Handle	14.02		Gills/Vannas Scissors, 10mm, Straight	25.01	A
Fine/Thornton 16mm Ring w/Swivel Handle	14.01	C	Gills/Vannas Scissors, 7mm, Curved	25.01	
Fine/Thornton II Ring 13mm w/11mm Opening...	14.02	A	Gills/Vannas X-Thin 7mm Sharp Blades, Straight	25.01	
Fine-Nagahara Phaco Chopper, Left Hand...	7.01	C	Gills/Welsh Vannas Scissors, Angled, 11mm Blades	25.01	B
Fine-Nagahara Phaco Chopper, Left Hand...	7.01		Gills/Welsh, 25g, Angled 10mm Tip	5.02	
Fine-Nagahara Phaco Chopper, Right Hand...	7.01		Gills/Welsh, 25g, Angled 5mm Tip	5.02	
Fine-Nagahara Phaco Chopper, Right Hand...	7.01		Gills/Welsh, 25g, Angled 7mm Tip	5.02	
Fine-Nichamin Quick I Double Chopper Left Hand...	7.06		Gills/Welsh, 25g, Angled 8mm Tip	5.02	
Fine-Nichamin Quick I Double Chopper Left Hand...	7.06		Gills/Welsh, 25g, Angled 9mm Tip	5.02	A
Fine-Nichamin Quick I Double Chopper Right Hand...	7.06	A	Gillum Irrigating Phaco Splitter	5.10	A
Fine-Nichamin Quick I Double Chopper Right...	7.06		Gillum Open-Ended Irrigating Phaco Splitter...	8.01	C
Fixation	22.02		Gillum Phaco Splitter	7.01	D
Fixation Rings	14.01, 14.02		Gillum Retrobulbar Guide	20.01	E
Flexible Stainless Ruler	4.01		Gillum Side Port Splitter-Left Hand...	7.02	
Flexible Stainless Ruler, 6" x 1/2"	4.01	A	Gillum Side Port Splitter-Right Hand...	7.02	A
Foldable Lens	13.27-13.33		Gimbel Irrigating Cannula, 30g, 28mm	5.02	B
Foldable Lens Cutters			Girard Anterior Chamber Needle Set, 23g	5.14fgrndon	D
Foldable Lens Loaders & Inserters	13.21-13.24		Girard Corneo-Scleral, .12mm 1x2 Teeth	13.14	A
Forceps Miscellaneous	13.35		Girard Swan Knife, 1.5mm Blade	11.01	B
Forceps, Bi-Polar	13.01		Glaucoma Marker 5mm x 5mm	24.04	C
Forceps, Capsule, Stainless	13.01-13.04		Globe Fixation Instruments	14.01-14.03	
Forceps, Capsule, Titanium	13.05-13.07		Goldberg Side Port Nucleus Splitter	15.08	E
Forceps, Chalazion	13.09		Goldberg Side Port Nucleus Splitter-Titanium	15.08	
Forceps, Cilia	13.10		Goldman Capsulorrhexis Forceps	13.06	B
Forceps, Corneal, Stainless	13.11-13.17		Golf Club Spud	20.02	A
Forceps, Corneal, Titanium	13.19		Gradle Cilia Forceps, 1.4mm Wide Jaws	13.10	D
Forceps, Cystotome	13.04-13.07		Graefe Iris, 1x2 Teeth, Curved	13.14	
Forceps, Dressing	13.20		Graefe Iris, 1x2 Teeth, Straight	13.14	B
Forceps, Jeweler	13.25, 13.26		Graefe Iris, Serrated Tip, Curved	13.13	
Forceps, Mosquito	13.36		Graefe Iris, Serrated Tip, Straight	13.13	C
Forceps, Nucleus Splitting	13.37		Graether Collar Button, 23g, Angled	5.03	C
Forceps, PMMA Lens	13.29		Graether Collar Button, 23g, Straight	5.03	
Forceps, PRK, LASIK, Intralase	22.01		Graether Collar Button, Angled	15.01	
Forceps, Serrifine	13.37		Graether Collar Button, Straight w/Guard	15.01	D
Forceps, Tying, Stainless	13.38-13.40				
Forceps, Tying, Titanium	13.41-13.43				

31.03

STRYKER
ELEVATING THE QUALITY OF CARE

1-800-263-3557

ALPHABETICAL INDEX

Grandon >>> Kershner

31.04

Description	Page	Photo
Grandon I&A, "03", 23g x 23g, Aspiration, Top Left	5.08	C
Grandon I&A, "04", 23g x 23g, Aspiration, Top Right	5.08	
Green Fixation, 5mm Jaws 8x9 Teeth	13.14	D
Green Strabismus Hook 5"	15.11	A
Guell LASIK Irrigation Cannula, 25g	5.11	F

H

Halsted Mosquito Forceps, 5", Curved Standard	13.36	A
Halsted Mosquito Forceps, 5", Curved X-Delicate	13.36	B
Halsted Mosquito Forceps, 5", Straight Standard	13.36	C
Halsted Mosquito Forceps, 5", Straight X-Delicate	13.36	D
Handle, Delron	5.01	
Handles, I&A	16.02	
Handpiece & Tip Sterilization Tray	16.02	C
Hardten Double Ended LASIK Flap Lifter & Spatula	22.08	C
Hardten LASIK Flap Epithelial Removal Platform	22.06	D
Harms Colibri Forceps - .12mm w/Tying Platforms	13.14	E
Harms Tying Forceps, Curved 7mm Tying Platforms	13.38	
Harms Tying Forceps, Straight 7mm Tying Platforms	13.38	C
Hartman Mosquito Forceps, 3-1/2" Curved	13.36	E
Hartman Mosquito Forceps, 3-1/2" Straight	13.36	
He Hook Chopper - Left Handed Surgeon-Titanium	7.02	
He Hook Chopper - Right Handed Surgeon-Titanium	7.02	B
Heslin Infusion Cannula, 23g, 9mm Sandblasted	5.14	F
Heslin Infusion Cannula, 25g, 9mm Sandblasted	5.14	E
Hess Memory Lens Inserter-Titanium	13.22	A
Hirshman Spatula	9.02	C
Hoes	18.02, 18.03	
Hoffer-Optical Zone Marker 11.00mm	24.07	
Hoffer-Optical Zone Marker 3.00mm	24.07	A
Hoffer-Optical Zone Marker 3.25mm	24.07	
Hoffer-Optical Zone Marker 3.50mm	24.07	
Hoffer-Optical Zone Marker 3.75mm	24.07	
Hoffer-Optical Zone Marker 4.00mm	24.07	
Hoffer-Optical Zone Marker 4.25mm	24.07	
Hoffer-Optical Zone Marker 4.50mm	24.07	
Hoffer-Optical Zone Marker 4.75mm	24.07	
Hoffer-Optical Zone Marker 5.00mm	24.07	
Hoffer-Optical Zone Marker 5.50mm	24.07	
Hoffer-Optical Zone Marker 6.00mm	24.07	
Hoffer-Optical Zone Marker 7.00mm	24.07	
Hoffer-Optical Zone Marker 8.00mm	24.07	
Hoffman LASIK Irrigation Cannula, 25g	5.12	A
Hooks, Iris	15.01	
Hooks, Retreatment	22.07	
Hooks, Tenotomy	15.11	
Huang Epithelial LASEK Hoe	18.02	B
Huang 7.5mm LASEK Trephine w/Extension & Well	18.02	
Huang 8.5mm LASEK Trephine w/Extension & Well	18.02	A
Huang 9.5mm LASEK Trephine w/Extension & Well	18.02	
Huang LASIK Cannula, 2 Ports, 23g	5.12	B
Hunt Chalazion Forceps, 12mm	13.09	B
Hyde Corneal Forceps, 2x2 Teeth...	13.12	A

Description	Page	Photo
I		
Instrument Wipes	6.03	
INTACS Instruments	17.01	

J

Jaeger Lid Plate 4", Blades 20mm & 23mm	23.01	B
Jaffe Bone Plate, 11cm x 20mm, 1mm Thick, Blackened	20.02	B
Jaffe Eye Shield, Blackened	20.02	C
Jaffe Lens Manipulator, Straight, .15mm Diameter	15.04	C
Jaffe Lens Spatula, .5mm Wide	9.02	E
Jaffe Lid Retractor 30mm x 20mm, Blackened	23.01	C
Jaffe Lid Retractor 30mm x 24mm, Blackened	23.01	
Jaffe Lid Retractors (Pair)	26.06	A
Jaffe Mouth Guard, Blackened	20.02	
Jaffe Tying Forceps, Curved 6mm Tying Platforms	13.38	
Jaffe Tying Forceps, Straight 6mm Tying Platforms	13.38	D
Jaffe/Bechert Nucleus Rotator, Angled	15.09	A
Jaffe/Maltzman Lens Manipulator, .15 Diameter...	15.04	D
Jameson Caliper	4.01	C
Jameson Muscle Forceps, Left w/Lock	13.34	D
Jameson Muscle Forceps, Right w/Lock	13.34	
Jameson Strabismus Hook 5", Small	15.11	
Jameson Strabismus Hook, Large	15.11	B
Jarrett Side Port Nucleus Manipulator	15.09	B
Jensen Capsule Scraper, 23g, Sandblasted Tip	5.03	
Jensen Capsule Scraper, 23g, Semi-Sandblasted Tip	5.03	
Jensen Capsule Scraper, 25g, Semi-Sandblasted Tip	5.03	D
Jensen Capsule Scraper, 25g, Semi-Sandblasted Tip	5.03	
Jensen Capsule Scraper, 27g, Sandblasted Tip	5.03	E
Jensen Capsule Scraper, 27g, Semi-Sandblasted Tip	5.03	
Johnson Spatula, 10mm Long	9.03	A
Johnston Axis Marker & LASIK Spatula, 13mm Spread	22.04	C
Johnston LASIK Cannula, Flat Tip, Rounded Distal Tip...	5.14	C
Johnston LASIK Fixation Ring-Titanium	22.02	A
Johnston LASIK Flap Applanator-Stainless	22.01	A
Johnston LASIK Flap Applanator-Titanium	22.01	

K

Kalt 5-1/4", Standard, Delicate Jaws, Stainless	21.02	C
Katzen Transplant Mini, Curved Medium, Left	25.03	C
Katzen Transplant Mini, Curved Medium, Right	25.03	
Kellan Hydro-Elevation 27g Cannula	5.07	A
Kellan Inserter-Titanium	13.22	B
Kellan Nucleus Dissection Spatula	19.01	D
Kellan Nucleus Elevation Spatula	19.01	E
Kellan Nucleus Manipulator	19.01	F
Kellan Viscoelastic 21g Cannula	5.17	A
Kelly Descemet's Punch	20.02	E
Kelman Cyclodialysis Cannula, 19g, Flat Left	5.05	
Kelman Cyclodialysis Cannula, 19g, Flat Right	5.05	C
Kelman/McPherson, 1x2 .12mm Teeth, Angled...	13.16	
Kelman/McPherson, Angled 8mm Tying Platforms	13.39	A
Kelman/McPherson, Angled, 8mm, 3-3/8"...	13.41	D



ELEVATING THE QUALITY OF CARE IN OPHTHALMOLOGY
800-637-4346



ALPHABETICAL INDEX

Kershner >>> Manche

31.05

Description	Page	Photo	Description	Page	Photo
Kelman/McPherson, Angled, 8mm, 4"-Titanium	13.42	A	Kratz/Barraquer Wire Speculum, Nasal Fit	26.01	D
Kelman/McPherson, Round Handle, Angled...	13.39	B	Kremer Fixation Forceps 1x2, .12mm Curved	13.15	A
Kershner 5mm Diameter Arcuate A/K Marker	24.04		Kremer Fixation Forceps 1x2, .12mm Straight	13.15	
Kershner 6mm Diameter Arcuate A/K Marker	24.04		Kuglan Lens Manipulator, Angled-Titanium	15.01	
Kershner 7mm Diameter Arcuate A/K Marker	24.04		Kuglan Iris Hook, Angled	15.01	E
Kershner 8mm Diameter Arcuate A/K Marker	24.04		Kuglan Iris Hook, Straight	15.01	
Kershner 9mm Diameter Arcuate A/K Marker	24.04	A	L		
Kershner Butterfly Capsulorrhexis Forceps, Long	13.02	A	Lambert Chalazion Forceps, 8mm	13.09	C
Kershner Butterfly Capsulorrhexis Forceps, Short	13.02	B	Lancaster Open Wire Katz Style	26.06	E
Kershner Capsulorrhexis Forceps, 8mm Blades...	13.06	C	LASEK Instruments	18.01-18.03	
Kershner Clear Corneal I&A Tip w/0.3mm Asp.	16.03	F	Lehner I Lens Inserter	13.28	D
Kershner Foldable Lens Insertion Forceps	13.28	B	Lehner I Loader-Titanium	13.22	C
Kershner II 23g Stainless Micro Capsulorrhexis...	13.02	C	Lehner II Acrylic Lens Inserter-Titanium	13.22	D
Kershner LASIK Flap Forceps	22.01		Lehner II Acrylic Lens Loader-Titanium	13.22	E
Kershner LRI Marker, 8mm ID, 10mm OD...	24.07	D	Lens Cutters,	19.01	
Kershner Reversible Speculum, Fenestrated Blades	26.03	B	Lens Loop 3mm Wide, 3 Ports	5.10	C
Kershner Reversible Speculum, Solid Blades	26.03	A	Lens Loops	15.10	
Kershner-Nichamin 30 Degree 10.0mm LRI Marker	24.08	A	Lens Manipulators	15.02-15.06	
Kershner-Nichamin 45 Degree 10.0mm LRI Marker	24.08	B	Lester Fixation 1x2 Teeth	13.15	B
Kershner-Nichamin 60 Degree 10.0mm LRI Marker	24.08	C	Lester Fixation 2x3 Teeth	13.15	C
Kershner-Nichamin 75 Degree 10.0mm LRI Marker	24.08	D	Lester Lens Manipulator, Angled-Titanium	15.04	
Kershner-Nichamin 90 Degree 10.0mm LRI Marker	24.08	E	Lester Lens Manipulator, Straight-Titanium	15.04	
Khouri "J" I&A Cannula, 26g Irr., 23g Asp...	5.08	E	Lester Lens Pusher, Angled, Round Handle	15.04	E
Khouri 3mm Nucleus Removal Spoon	5.09	A	Lester Lens Pusher, Straight w/Guard...	15.04	
Khouri Cutting Board, Left Hand Dominant...	19.02		Lester Modified Hook, Angled, Round Handle	15.05	A
Khouri Cutting Board, Right Hand Dominant...	19.02	A	Level For Brems (8-16151) Marker	22.04	
Khouri Cutting Fork, Left Hand Dominant Surgeon	19.02		Lewicky Lens Manipulator, Angled, .15mm Diameter	15.05	C
Khouri Cutting Fork, Right Hand Dominant Surgeon	19.02	B	Lewis Lens Loop 5-1/4", Serrated Loop 5.5x8mm	15.10	
Khouri Hydrodissection Cannula, 23g, Left	5.07	B	Lewis Lens Loop 5-1/4", Smooth Loop 5.5x8mm	15.10	D
Khouri Hydrodissection Cannula, 23g, Right	5.07		Lieberman Open Wire Kratz Style Speculum w/Asp...	26.06	F
Khouri Nuclear Fragment Removal Forceps	13.03	A	Lieberman Open Wire Kratz Style Speculum...	26.06	G
Khouri Phaco Nucleus Manipulator	15.05	E	Lieberman Speculum, V-Wire, Aspiring, Temp...	26.07	A
Khouri Phacofragmentation System, Left Hand...	19.02		Lieberman Speculum, V-Wire, Temporal Fit	26.07	B
Khouri Phacofragmentation System, Right Hand...	19.02		Lindstrom 90 Degree Sandblasted I&A Tip 0.3mm	16.04	B
Kimura Malleable Flat Spatula, 4mm Wide	9.03	B	Lindstrom LASIK Spatula & Marker	22.04	D
Knapp (Rollet) 5-1/4", 4 Sharp Prongs	23.01	D	Lindstrom Lens Inserter - Titanium	13.23	A
Knapp 5-1/4", 4 Blunt Prongs	23.01		Lindstrom Lens Insertion Forceps w/Notch...	13.29	A
Knolle Anterior Chamber, 23g, Angled 2mm Tip...	5.02	D	Lindstrom Lens Insertion Forceps w/o Notch...	13.29	
Knolle Anterior Chamber, 25g, Angled 2mm Tip...	5.02		Lindstrom PRK Spatula & 7mm Marker	22.05	A
Knolle Anterior Chamber, 27g, Angled 2mm Tip...	5.02		Lindstrom Star Nucleus Manipulator, Angled...	15.09	E
Knolle Anterior Chamber, 30g, Angled 2mm Tip...	5.02		Lindstrom Trident Splitter - Left Hand Dominant	7.02	
Knolle Capsule Scraper, 23g, 2mm Sandblasted Tip	5.03	F	Lindstrom Trident Splitter - Right Hand Dominant	7.02	C
Knolle Capsule Scraper, 30g, 2mm Sandblasted Tip	5.03		Lindstrom-Chu Aspiration Speculum, Temp. & Nasal...	26.03	C
Knolle Lens Nucleus Spatula	9.03	C	Little Suture Caring Scissors, 4-5/8" w/Suture...	25.06	B
Knolle/Pearce Vectis, 23g, 3 Outer Ports	5.09	B	Livermois Fixation Loop	14.02	D
Knolle/Shepard w/Peg, Serrated Jaws	13.33	B	Luer Adaptor Tip For Cannulas	16.03	E
Koch Nucleus Manipulator	15.09		M		
Koch Nucleus Manipulator	15.09	D	Machat Double Ended Intralase Spatula w/Sinsky...	22.03	A
Koch-Salz Nucleus Splitter-Titanium	13.37	A	Mackool, Capsule Retractor	15.02	A
Kraff Capsule Polisher, 25g Irrigation Port/Center	5.03	G	Maldonado UAF LASIK Marker	24.06	D
Kraff Lens Insertion Forceps	13.28	C	Maloney Astigmatism Keratometer	24.08	F
Kratz Barraquer Pediatric Speculum, Temporal Fit	26.05	D	Maltzman/Fenzl Hook, .15mm Straight w/Guard	15.05	C
Kratz Capsule Scraper, 23g, 1mm Sandblasted Tip	5.04	A	Manche LASIK Irrigation Cannula, 25g	5.12	D
Kratz Wire Speculum w/Wings, Temporal Fit	26.06	B			
Kratz/Barraquer w/Aspiration, Adult...	26.06	D			
Kratz/Barraquer w/Aspiration, Child...	26.06				
Kratz/Barraquer Wire Speculum, Adult, Temp...	26.06	C			



ELEVATING THE QUALITY



1-800-263-3557

ALPHABETICAL INDEX

Mansur >>> Nichamin

31.06

Description	Page	Photo	Description	Page	Photo
Mansur-Aran Graft Harvesting & Pterygium...	25.05	D	Meyerhoefer Curette Size 2, 2.0mm	15.11	
Markers, AK	24.03,24.04		Meyerhoefer Curette Size 3, 2.5mm	15.11	
Markers, LRI	24.05-24.08		Meyerhoefer Curette Size 4, 3.5mm	15.11	
Markers, Optical Zone	24.10		Miguel Maldonado LASIK Posterior Ablation...	22.02	E
Markers, RK	24.01, 24.02		Mini Crescent Blades, 1.25mm Angled, Bevel Up...	3.02	A
Masket Sub-Tenon Anesthesia Cannula, 19g	5.16	A	Mitchell Viscoelastic Removal I/A Tip	16.04	C
Mat For 11" x 14" Tray	27.01		Moretsky LASIK Hinge Fixation Protector-Titanium	22.02	C
Mat For 6" x 9" Tray	27.01		Mouth Guard	20.02	
Mat For 7"x11" Tray #05-6023	27.02				
Mat For 8" x 13" Tray	27.01				
Maumenee Colibri .12mm 1x2 Teeth	13.15	D			
McIntyre II 3mm Irrigating Removal Spoon, Small	5.09	D			
McIntyre II 4.5mm Irrigating Removal Spoon, Large	5.09				
McIntyre II Cutting Board-Left Hand Dominant...	19.02	B	Nagahara 20g Dual Port Irrigating Phaco Chopper, L...	8.01	D
McIntyre II Cutting Board-Right Hand Dominant...	19.02	C	Nagahara 20g Dual Port Irrigating Phaco Chopper, R...	8.01	
McIntyre II Double Cleaver - Left Hand Dominant...	19.02	E	Nagahara 20g Irrigating Chopper w/Open Ended...	8.01	E
McIntyre II Double Cleaver - Right Hand Dominant...	19.02		Nagahara Phaco Chopper, Left Hand Dominant	7.02	
McIntyre II Single Cleaver - Left Hand Dominant...	19.02		Nagahara Phaco Chopper, Left Hand Dominant...	7.02	
McIntyre II Single Cleaver - Right Hand Dominant...	19.02	D	Nagahara Phaco Chopper, Right Hand Dominant...	7.02	D
McIntyre II Splitting/Removal System-Left Hand...	19.02		Nagahara Phaco Chopper, Right Hand Dominant...	7.02	
McIntyre II Splitting/Removal System-Left Hand...	19.02		Needle Holders, Stainless & Titanium	21.01-21.03	
McIntyre II Splitting/Removal System-Right Hand...	19.02		New McIntyre Speculum, Nasal Fit	26.02	B
McIntyre II Splitting/Removal System-Right Hand...	19.02		New Orleans Lens Loop 5-1/4", Smooth Loop	15.10	E
McIntyre III 21g Debulking Cannula	5.07	E	Newsom Side Port Nucleus Cracker	15.09	F
McIntyre III 27g Hydrodissection Cannula	5.07	D	Newsom Side Port Nucleus Cracker	15.09	F
McIntyre III Chamber Maintainer, 19g Tip	5.15	B	Nichamin 20g Dual Port Irrigating I Quick Chopper-L...	8.01	F
McIntyre III Fragment Extractor-Left Hand...	19.03		Nichamin 20g Dual Port Irrigating I Quick Chopper-R...	8.01	
McIntyre III Fragment Extractor-Right Hand...	19.03	C	Nichamin 20g Dual Port Irrigating Triple...	8.02	A
McIntyre III Nucleus Cutter-Left Hand...	19.03		Nichamin 20g Irrigating I Quick Chopper ...	8.02	
McIntyre III Nucleus Cutter-Right Hand...	19.03	A	Nichamin 20g Irrigating I Quick Chopper...	8.02	B
McIntyre III Nucleus Cutting Spatula-Left Hand...	19.03		Nichamin 20g Irrigating Vertical Chopper...	8.02	C
McIntyre III Nucleus Cutting Spatula-Right Hand...	19.03	B	Nichamin Fixation Ring w/10 Degree Marks...	14.01	D
McIntyre Speculum	26.02	A	Nichamin Formed Quick Pick Chopper...	7.03	F
McIntyre, Straight w/Lock, Stainless	21.02	D	Nichamin I Foldable Lens Insertion Forceps...	13.23	B
McPherson Angled Bi-Polar Forceps	13.01		Nichamin I Foldable Lens Loading Forceps...	13.23	C
McPherson Straight Bi-Polar Forceps	13.01	B	Nichamin I Quick Chopper & Nucleus Pick-Left...	7.06	
McPherson X-Delicate, Curved w/Lock, Stainless	21.02	E	Nichamin I Quick Chopper & Nucleus Pick-Left...	7.06	
McPherson X-Delicate, Curved w/o Lock, Stainless	21.02		Nichamin I Quick Chopper & Nucleus Pick-Right...	7.06	B
McPherson X-Delicate, Straight w/Lock, Stainless	21.02		Nichamin I Quick Chopper & Nucleus Pick-Right...	7.06	
McPherson X-Delicate, Straight w/o Lock, Stainless	21.02		Nichamin I Quick Chopper-Left Hand Dominant	7.02	
McPherson, 1x2 .12mm Teeth, Angled 5mm Tying...	13.16	A	Nichamin I Quick Chopper-Right Hand Dominant	7.02	E
McPherson, 1x2 .12mm Teeth, Straight 5mm Tying...	13.16		Nichamin II Foldable Lens Insertion Forceps...	13.23	D
McPherson, Angled, .12mm Teeth, w/Platform...	13.19	A	Nichamin II Foldable Lens Loading Forceps...	13.24	A
McPherson, Angled, 5mm, 3-3/8"-Titanium	13.42	B	Nichamin II Quick Chopper, Left Hand Dominant...	7.03	
McPherson, Angled, 5mm, 4"-Titanium	13.42		Nichamin II Quick Chopper, Right Hand Dominant...	7.03	
McPherson, Angled, Micro 5mm Tying Platforms	13.39	C	Nichamin III Foldable Lens Loading Forceps...	13.24	B
McPherson, Straight, Micro 5mm Tying Platforms	13.39		Nichamin IV Foldable Lens Loading Forceps...	13.24	C
McPherson/Vannas 3-1/4", Curved Sharp Points	25.01		Nichamin Open-Ended Formed Quick Pick...	8.02	D
McPherson/Vannas 3-1/4", Straight Sharp Points	25.01	C	Nichamin Quick Chopper-Left Hand Dominant...	7.03	
McPherson/Westcott, Curved Blunt Tips	25.07	A	Nichamin Quick Chopper-Right Hand Dominant...	7.03	A
McPherson/Westcott, Sharp Points, Small Blades	25.06	C	Nichamin Sapphire Fixation Knife	10.04	H
McPherson/Westcott, Straight Blunt Tips	25.07		Nichamin Triple Chopper & Quick I Chopper-Left...	7.06	
Melki LASIK Flap Stabilizer, 9mm Platform...	22.02	D	Nichamin Triple Chopper & Quick I Chopper-Left...	7.06	
Mendez Degree Gauge	24.07	B	Nichamin Triple Chopper & Quick I Chopper-Right...	7.06	C
Meyerhoefer Curette Size 0, 1.5mm	15.11		Nichamin Triple Chopper & Quick I Chopper-Right...	7.06	
Meyerhoefer Curette Size 00, 1.0mm	15.11	E	Nichamin Triple Chopper w/Spatula	7.03	B
Meyerhoefer Curette Size 1, 1.7mm	15.11		Nichamin Triple Nucleus Chopper	7.03	C
			Nichamin Triple Nucleus Chopper-Titanium	7.03	
			Nichamin Vertical Nucleus Chopper	7.03	D



ELEVATING THE QUALITY OF CARE IN OPHTHALMOLOGY
800-637-4346



1-800-263-3557

ALPHABETICAL INDEX

Nucleus >>> Seibel

31.07

Description	Page	Photo
O		
Nucleus Fragmentation	19.01	
Nucleus Hooks	15.07-15.10	
Olson 20g Irrigating Chopper w/Open Ended...	8.01	E
Olson 21g Irrigating Quick Chopper, Left Hand...	5.10	
Olson 21g Irrigating Quick Chopper, Right Hand...	5.10	B
Osher "Y" Hook, Straight	15.05	D
Osher Implant Hook, 24g, w/30g Tip	5.15	E

Description	Page	Photo
P		
Paton Double Ended Corneal Spatula And Spoon	9.03	D
Peribulbar, 23g Atkinson, 1"	5.18	C
Peribulbar, 23g Atkinson, 5/8"	5.18	
Peribulbar, 23g, Atkinson, 1-1/4"	5.18	
Peribulbar, 23g, Atkinson, 7/8"	5.18	
Peters Pupil Dilator	12.02	A
Peters Pupil Dilator Loop	12.02	
Pettigrove Aspirating LASIK Speculum, Temporal...	26.07	C
Pettigrove Irrigating LASIK Cannula	5.12	E
Pettigrove LASIK Marker	22.05	B
Pfister PKP Suture Adjuster, Thin Tip	20.04	B
Pfister PKP Suture Adjustment Forceps & Spatula	13.39	D
Pfister PKP Suture Pincher, Wide Tip	20.04	A
Phillips Gravity Axis Marker, 10mm ID, 14mm OD	22.05	C
Pierse Colibri, .1mm Teeth	13.16	B
Pierse Colibri, .3mm Teeth	13.16	
Pierse Type, Curved, w/Platform, 3-3/8"-Titanium	13.19	
Pierse Type, Straight, w/Platform, 3-3/8"-Titanium	13.19	B
Plager LASIK Flap Lifter & Irrigator	5.12	F
Polack, Double .12mm Corneal Fixation	13.16	C
Polack, Double Corneal Fixation Pierse .1mm	13.16	
Punches	20.01, 20.02	
PVAc Instrument Wipes, 30/Box	6.03	B

Description	Page	Photo
R		
Randolph Cyclodialysis, 19g, Front Opening	5.05	D
Randolph Cyclodialysis, 21g, Front Opening	5.05	
Retinal Instruments	29.00	
Retractors	23.01	
Retrobulbar, Atkinson, 23g, 1-1/2" Long	5.18	D
Retrobulbar, Atkinson, 25g, 1-1/2" Long	5.18	
Reusable 18 Gauge Cautery Pen, 45 Degree Bevel	20.03	A
Reusable 18 Gauge Cautery Pen, Dual Broad Tip	20.03	B
Reusable 23 Gauge Cautery Pen, Tapered Tip	20.03	C
Reusable Knives	11.01	
Rhein Advantage I Diamond LRI Knife, 1mm Wide...	10.01	H
Rhein Advantage II Diamond LRI Knife, 0.75mm...	10.01	I
Rhein Artisan Lens Holding Forceps, Direct Acting...	13.32	B
Rhein Artisan Lens Holding Forceps, Reverse Acting...	13.32	
Rhein Capsulorhexis Cystotome Forceps	13.06	D
Rhein Colibri Capsulorhexis Forceps...	13.05	E
Rhein Cross Action Pierse Tooth Lens Forceps...	13.29	C
Rhein Crystalens Lens Insertion Forceps	13.30	E
Rhein Disposable Knife Cleaning Packs, 12/Box	10.07	A

Description	Page	Photo
Rhein I Lens Holding Forceps	13.32	C
Rhein ICL Retrieval Forceps, 12mm Blades, Angled ...	13.30	D
Rhein II Lens Holding Forceps	13.32	D
Rhein III Foldable Lens Loader-Titanium	13.24	D
Rhein Incision Gauges, 100um Increments...	4.01	D
Rhein LASIK Aspiration Cannula	5.13	A
Rhein LASIK Flap Elevator & Stromal Spatula	22.09	A
Rhein LASIK Flap Forceps, Curved On Side Of...	22.01	C
Rhein LASIK Flap Forceps, Curved Toward Handle...	22.01	D
Rhein LASIK Flap Forceps, Solid Blades	22.01	E
Rhein LASIK Irrigation Cannula	5.12	G
Rhein Open Sub-Tenon Anesthesia Cannula, 19g	5.16	B
Rhein Open-Ended Quick Pick Chopper, Irrigating	8.02	F
Rhein Quick Pick Chopper, Non-Irrigating	7.03	E
Rhein R/K & A/K Knife, Rectangular Blade, Microm...	10.05	A
Rhein Reusable Knife Cleaning Cradle w/One Pack	10.07	B
Rhein Tubular 23g Capsulorhexis Forceps, 1.0mm...	13.03	B
Rhein Tubular 23g Capsulorhexis Forceps, 1.0mm...	13.07	A
Rhein Universal Lens Insertion Forceps-Titanium	13.29	B
Rhein, Straight, 45 Degree 1x2 Teeth, .12mm...	13.19	C
Rhein/Maumenee Cross Action-Titanium	13.42	C
RK Micrometer Knife, Double Edge 45 Degree...	10.05	B
Roper Alpha-Chymotrypsin Cannula, 19g	5.02	E
Round Handle w/Flat Ridge, Curved, 4"-Titanium	13.42	D
Round Handle w/Flat Ridge, Straight, 4"-Titanium	13.43	A
Rousseau Chin Lift Stabilizer	14.03	D
Rousseau Dual-Tip Slit Lamp Mounted Axis Marker	24.07	E
Rousseau IntraLase Flap Spreader	22.03	B
Rowen White-To-White Corneal Gauges...	4.01	E
Rubenstein LASIK Irrigation Cannula, 23g	5.13	B
Rubman-Bores Fixation Forceps, 1x2, Curved...	13.16	D
Ruedemann Infant Lacrimal Dilator 3", .5mm	12.02	B
Ruminson Astigmatic Gauge & Marker, 7mm...	24.06	E
Ruminson Hydrodissection Luxation Cannula	5.07	F
Ruminson Side Port Fixation Occluder-Tip Left	14.02	E
Ruminson Side Port Fixation Occluder-Tip Right	14.02	

Description	Page	Photo
S		
Sabet Lenticular Safety Net	13.02	D
Sabet Lenticular Safety Net, Extra Wire Basket	13.02	
Salz Nucleus Splitter-Titanium	13.37	B
Same As #8-13114 w/Allen Plunger Retractor	20.04	
Sauer 1-1/4", Infant Size, 10mm Blades, Temp...	26.07	D
Sauer Suturing Forceps, .6mm Teeth	13.16	E
Schepens Orbital Retractor, Smooth, Forked...	23.01	E
Schiotz Tonometer, Original Model w/3 Weights...	20.04	E
Schlemm's Canal Tissue Forceps, Stainless	13.34	A
Schlemm's Canal Tissue Forceps, Titanium	13.34	B
Schochet Double Ended Depressor w/Clip, 6mm...	20.04	
Scissors, Capsulotomy	25.01	
Scissors, Corneal	25.02, 25.03	
Scissors, Iris	25.04	
Scissors, Miscellaneous	25.05	
Scissors, Stitch	25.06	
Scissors, Tenotomy	25.07	
Seibel 20g Dual Port Irrigating Nucleus Chopper-Left	8.02	



1-800-263-3557

ALPHABETICAL INDEX

Seibel >>> Steinert

31.08

Description	Page	Photo	Description	Page	Photo
Seibel 20g Dual Port Irrigating Nucleus Chopper-R...	8.02	G	Short Capsulorrhexis Forceps, Straight Cystotome...	13.04	B
Seibel 20g Dual Port Irrigating Vertical Safety Quick...	8.03		Silicon Squeeze Bulb	5.01	
Seibel 20g Dual Port Irrigating Vertical Safety Quick...	8.03	A	Silicone Sleeve Replacements	16.04	E
Seibel 20g Irrigating Safety Chopper w/Open ...	8.03		Simcoe Capsule Scraper, 23g, 13mm Length	5.04	B
Seibel 20g Irrigating Safety Chopper w/Open...	8.03	B	Simcoe Cortex Extractor, 23g, 0.3mm Port, 13mm	5.04	G
Seibel 3-D Speculum	26.07	E	Simcoe Cortex Extractor, 23g, 0.3mm Port, 21mm	5.04	
Seibel Double-Ended LASIK Flap Lifter & Spatula	22.09	B	Simcoe Cortex Extractor, 23g, 0.4mm Port, 21mm	5.04	
Seibel I IntraLase Flap Lifter & Retreatment Spat...	22.03	C	Simcoe Double Barreled I&A Cannula, 23g x 23g...	5.08	F
Seibel II IntraLase Flap Lifter & Retreatment Spat...	22.03	D	Simcoe Double Barreled I&A Reverse Cannula, 23g...	5.08	G
Seibel LASIK Flap Irrigator & Squeegee, Left Ports	5.13		Simcoe Nucleus Loop Left, 25g, Two Ports, 4mm	5.09	F
Seibel LASIK Flap Irrigator & Squeegee, Right Ports	5.13	C	Simcoe Nucleus Loop Right, 25g, Two Ports, 4mm	5.09	
Seibel Loader w/Lock-Titanium	13.21		Simcoe Nucleus Spatula, 25g, Flattened Tip	5.15	C
Seibel Loader w/Lock-Titanium	13.24	E	Simcoe Reverse Aperture Posterior Scrubber...	5.04	C
Seibel LRI Diamond Knife, 1mm Wide, Presets...	10.04	D	Single Stack Tray, 6" x 10" x 0.75"	27.02	A
Seibel Nucleus Chopper & Safety Quick ...	7.07		Single Sterilization Tray 7.5" x 4"	27.02	
Seibel Nucleus Chopper & Safety Quick Chopper, R...	7.07	A	Single Sterilization Tray, 11" x 14"	27.01	E
Seibel Nucleus Chopper & Safety Quick Chopper, R...	7.07		Sinskey Hook, 0.25mm Angled Round	15.06	A
Seibel Nucleus Chopper & Safety Quick Chopper...	7.07		Sinskey Hook, Angled, .15mm Tip	15.06	
Seibel Nucleus Chopper, Angled-Left Hand...	7.04		Sinskey Hook, Angled-Titanium	15.06	
Seibel Nucleus Chopper, Angled-Right Hand...	7.04		Sinskey Hook, Straight-Titanium	15.06	
Seibel Nucleus Chopper, Straight-Left Hand...	7.04		Sinskey II Hook, Angled, .18mm Diameter	15.06	
Seibel Nucleus Chopper, Straight-Right Hand...	7.04		Sinskey II Hook, Straight w/Guard, .18mm Diameter	15.06	
Seibel Nucleus Chopper-Left Hand, Angled...	7.04		Sinskey Tying Forceps, Curved	13.40	B
Seibel Nucleus Chopper-Left Hand, Straight...	7.04		Sinskey Tying Forceps, Straight	13.40	
Seibel Nucleus Chopper-Right Hand, Angled...	7.04	A	Sisler Punctum Dilator	12.02	C
Seibel Nucleus Chopper-Right Hand, Straight...	7.04		Slade LASIK 26g Formed Irrigation Cannula	5.13	D
Seibel Paracentesis Valve Adjuster	20.05	A	Slade LASIK Irrigation Cannula, 27g	5.13	E
Seibel Vertical Safety Quick Chopper, Left Hand...	7.04		Snellen Entropium Forceps, Left 35mm Plate	13.09	
Seibel Vertical Safety Quick Chopper, Left Hand...	7.04		Snellen Entropium Forceps, Right 35mm Plate	13.09	D
Seibel Vertical Safety Quick Chopper, Right Hand...	7.04	B	Spatulas,	9.01-9.03, 18.03, 19.01, 19.03, 20.02, 22.03, 22.08-28.09	
Seibel Vertical Safety Quick Chopper, Right Hand...	7.04		Speculums, Nasal	26.01, 26.02	
Serdarevic Fixation Speculum, Nasal Fit	26.02	C	Speculums, Reversible	26.03	
Serdarevic Lens Insertor	13.29	D	Speculums, Temporal	26.04-26.08	
Serrefine 1-1/2", Curved With Suture Hole	13.37	C	Spivack Axis Marker, 11.5mm Spread	22.05	D
Serrefine 1-1/2", Straight With Suture Hole	13.37	D	Spoons	20.05, 29.04	
Serrefine 2-1/2", Curved With Suture Hole	13.37		Squeeze Bulb	5.01	
Serrefine 2-1/2", Straight With Suture Hole	13.37		Stainless Blade Holders	2.01	
Sharvelle Side Port Nucleus Splitter	15.10	A	Stainless Blades	3.01	
Sharvelle Side Port Nucleus Splitter-Titanium	15.10		Stainless Blades, Crescent	3.02	
Sheets Irrigation Vectis, 23g With Serrations	5.09	E	Stamler Corneal Transplant Stabilizer	14.03	A
Sheets Irrigation Vectis, 23g Without Serrations	5.09		Stamler Side Port Fixation Hook - Left Hand...	14.03	
Sheets McPherson Forceps, Angled Tying 10.5mm...	13.40	A	Stamler Side Port Fixation Hook - Right Hand...	14.03	B
Shepard Lens Insertion Forceps	13.30	B	Statim 2000 Cassette Autoclave	1.01	A
Shepard Lens Insertion Forceps-Titanium	13.30	A	Statim 5000 Cassette Autoclave w/o Printer	1.01	C
Shepard Side Port Occluding Cannula	5.14	A	Statim 5000 Cassette Autoclave w/Printer	1.01	D
Shepherd 20g Irrigating Tomahawk Chopper...	8.03		Steinert Double-Ended LASIK Spatula	22.09	C
Shepherd 20g Irrigating Tomahawk Chopper...	8.03	C	Steinert I Claw Chopper	7.04	D
Shepherd Anterior/Posterior Capsule Polisher...	20.05	B	Steinert II 20g Dual Port Irrigating Claw Chopper	8.03	D
Shepherd Anterior/Posterior Capsule Polisher-Left	20.05	C	Steinert II Claw Chopper	7.04	E
Shepherd Anterior/Posterior Capsule Polisher-Right	20.05		Steinert II Claw Chopper-Titanium	7.04	
Shepherd Tomahawk Chopper-Left Hand Dominant...	7.04		Steinert II Lasik Speculum, Aspirating	26.08	A
Shepherd Tomahawk Chopper-Left Hand Dominant...	7.04		Steinert II Lasik Speculum, Non-Aspirating	26.08	
Shepherd Tomahawk Chopper-Right Hand Dominant...	7.04	C	Steinert III Double-Ended Claw Chopper	7.07	B
Shepherd Tomahawk Chopper-Right Hand Dominant...	7.04		Steinert III Double-Ended Claw Chopper-Titanium	7.07	
Short Capsulorrhexis Forceps, Formed Cystotome...	13.03	C	Steinert LASIK Hansa/Moria Speculum, Asp...	26.08	B
Short Capsulorrhexis Forceps, Formed Cystotome...	13.03	D			
Short Capsulorrhexis Forceps, Straight Cystotome...	13.04	A			



ELEVATING THE QUALITY OF CARE IN OPHTHALMOLOGY
800-637-4346



ALPHABETICAL INDEX

Steinert >>> Wallace

31.09

Description	Page	Photo
Steinert LASIK Hansa/Moria Speculum, Non-Asp...	26.03	C
Steinert LASIK Marker	22.05	E
Steinert Nasal Speculum, Nasal Fit	26.02	D
Steinert Suction Globe Stabilizer, 10mm x 4mm	22.06	A
Steinert-Koch Nucleus Manipulator, Curved...	15.10	B
Sterilization Tray, 2" x 6"	27.01	B
Sterilization Tray, 6" x 9"	27.01	
Sterilization Tray, 8" x 13"	27.01	
Sterilization Trays	27.00	
Stern/Gills Scissors, 10mm, Angled	25.01	
Stern/Gills Scissors, 7mm, Angled	25.01	
Stevens Curved 3-3/4" Blunt Tips Ribbon Type	25.07	
Stevens Curved Tenotomy Hook	15.11	C
Stevens Long Blades, Curved Blunt Points	25.07	
Stevens Long Blades, Curved Sharp Points	25.07	C
Stevens Long Blades, Straight Blunt Points	25.07	D
Stevens Long Blades, Straight Sharp Points	25.07	
Stevens Short Blades, Curved Blunt Points	25.07	
Stevens Short Blades, Curved Sharp Points	25.07	
Stevens Short Blades, Straight Blunt Points	25.07	E
Stevens Short Blades, Straight Sharp Points	25.07	
Stevens Straight 3-3/4" Blunt Tips Ribbon Type	25.07	B
Stolte Hawksbill Pre-Chopper, Angled Handle	13.33	D
Stolte Pre-Chopper, Angled Handle, Straight Blades	13.33	E
Stolte Pre-Chopper, Straight Handle, Straight Blades	13.33	F
Strabismus Scissors 4", Curved, Standard	25.05	B
Strabismus Scissors 4", Straight, Standard	25.05	
Strabismus Scissors 4-1/4", Curved, Ribbon	25.05	
Strabismus Scissors 4-1/4", Straight, Ribbon	25.05	C
Suarez Spreader	11.01	C
Suction Sabilizer & Manipulator	22.06	
Sung Reverse Nucleus Chopper-Left Hand...	7.05	
Sung Reverse Nucleus Chopper-Left Hand...	7.05	
Sung Reverse Nucleus Chopper-Right Hand...	7.05	A
Sung Reverse Nucleus Chopper-Right Hand...	7.05	
Suture Instruments	20.04	

T

Tennant Lens Probe, .4mm Diameter Tip, w/Collar	15.06	B
Tennant Superior Rectus Forceps, Curved	13.17	A
Tennant Tying Forceps, Curved 6mm Tying Plat...	13.40	C
Tennant Tying Forceps, Straight 6mm Tying Plat...	13.40	D
Thornton 16mm Diameter Fixation Ring w/Fixed...	14.01	B
Thornton 16mm Diameter Ring w/Swivel Handle	14.01	A
Thornton-Optical Zone Marker 3.00mm	24.10	B
Thornton-Optical Zone Marker 3.25mm	24.10	
Thornton-Optical Zone Marker 3.50mm	24.10	
Thornton-Optical Zone Marker 3.75mm	24.10	
Thornton-Optical Zone Marker 4.00mm	24.10	
Thornton-Optical Zone Marker 4.25mm	24.10	
Thornton-Optical Zone Marker 4.50mm	24.10	
Thornton-Optical Zone Marker 4.75mm	24.10	
Thornton-Optical Zone Marker 5.00mm	24.10	
Thorpe Corneal Forceps, 2x3 Teeth	13.17	B
Tonometer	20.04	
Tooke Knife 4-1/2", 2.5 x 15mm	11.01	D

Description	Page	Photo
Toyos Aqua-Chopper	7.05	B
Trephines,	18.01-18.02, 28.01	
Troutman Alpha-Chymotrypsin Cannula, 25g, Curved	5.02	F
Troutman Superior Rectus Forceps	13.17	D
Troutman/Castroviejo Micro, Left w/Lock	25.03	
Troutman/Castroviejo Micro, Right w/Lock	25.03	D
Troutman/Castroviejo Mini, Left w/Lock	25.03	
Troutman/Castroviejo Mini, Right w/Lock	25.03	
Troutman/Katzen Transplant, Curved Small Blad...	25.03	E
Troutman/Katzen Transplant, Curved Small Blade...	25.03	
Troutman-Barraquer Mini Blade Breaker/Holder	2.01	C
Trujillo LASIK Enhancement Hook	22.07	B
Trujillo LASIK Enhancement Rake	22.07	C
Trujillo LASIK Enhancement Wedge	22.07	D
Tsuneoka 20g Irrigating Chopper w/Open Ended...	8.03	E
Tyrell Iris Hook 5" Blunt	15.02	
Tyrell Iris Hook 5" Sharp	15.02	B

U

Ursell IOL Manipulator	15.06	C
Utrata 27g Hydrodissection "J" Cannula	5.07	C
Utrata Capsulorrhexis Forceps - Flat Handle	13.04	C
Utrata Capsulorrhexis Forceps - Round Handle	13.04	D
Utrata Capsulorrhexis Forceps, Flat Handle...	13.07	B
Utrata Capsulorrhexis Forceps, Round Handle...	13.07	C
Utrata Foldable Lens Cutter	19.01	C
Utrata Foldable Lens Retriever	13.33	C
Utrata/Kershner Capsulorrhexis Cystotome Forceps...	13.04	E
Utrata/Kershner Capsulorrhexis Cystotome Forceps...	13.07	D

V

Valve Adjuster,	20.05	
Verges 20g Irrigating Phaco Chopper w/Open Ended...	8.03	F
Verges Phaco Chopper	7.05	C
Verges Phaco Chopper-Titanium	7.05	
Vidaauri LASIK Irrigation Double Cannula, 25g	5.13	F
Vidaauri LASIK Vertical Double LASIK Cannula, 25g	5.13	
Viscoelastic Injection Cannula, 21g, 7mm Tip	5.15	D
Vitrectomy Instruments	29.00	
Von Graefe Cataract Knife #1, 1.5 x 25mm	11.01	E
Von Graefe Cataract Knife #2, 1.7 x 27mm	11.01	
Von Graefe Cataract Knife #3, 2 x 30mm	11.01	
Von Graefe Cataract Knife #4, 2.3 x 33mm	11.01	
Von Graefe Cataract Knife #5, 2.5 x 35mm	11.01	
Von Graefe Strabismus Hook, Large, 11mm	15.11	
Von Graefe Strabismus Hook, Medium, 10mm	15.11	D
Von Graefe Strabismus Hook, Small, 8mm	15.11	
Vukich Collamer & ICL Cartridge Loading Forceps...	13.31	D
Vukich ICL Diamond Blade, 3.10mm Width	10.02	D
Vukich ICL Manipulator	15.06	D
Vukich Loading Forceps, Direct Acting	13.31	C

W

Wallace-Maloney Fixation Diamond Knife	10.02	E
--	-------	---



1-800-263-3557

ALPHABETICAL INDEX

Wan >>> Ziegler

31.10

Description	Page	Photo
Wan Side Port Nucleus Splitter	15.10	C
Wan Side Port Nucleus Splitter-Titanium	15.10	C
Weinstein LASIK Fixation Ring & Flap Lifter	22.02	B
Wells Enucleation Spoon 6", Cup 21mm	20.05	D
Welsh Flat Olive Cortex Extractor, 25g, Left	5.05	A
Welsh Flat Olive Cortex Extractor, 25g, Right	5.05	
Welsh Flat Olive Cortex Extractor, 25g, Straight	5.05	B
Westcott 5-1/4" Left, Wide Handles, Blunt Tips	25.07	G
Westcott 5-1/4" Right, Wide Handles, Blunt Tips	25.07	
Westcott Curved, Blunt Tips, Medium Handles	25.07	F
Westcott Stitch 4-1/2", Curved Sharp Points	25.06	D
Wheller Dissection Knife	11.01	F
Wies Chalazion Forceps, 9x12mm	13.09	E
Wilbrandt-Binkhorst, 23g, Left	5.02	
Wilbrandt-Binkhorst, 23g, Right	5.02	
Wilbrandt-Binkhorst, 23g, Straight	5.02	C
Wilder Lacrimal Dilator, Fine Taper	12.02	D
Wilder Lacrimal Dilator, Heavy Taper	12.02	
Wilder Lacrimal Dilator, Medium Taper	12.02	
Wilder Lens Loop 5-1/4", Serrated Loop 4x15mm	15.10	F
Wilder Lens Loop 5-1/4", Smooth Loop 4x15mm	15.10	
Williams 2-3/4", Small Blades 11x5mm, Temp...	26.08	
Williams 3-1/4", Large Blades 15 x5mm, Temp...	26.08	D
Winter Helping Hand Chopper - Double Ended	7.07	C
Winter Helping Hand Chopper - Double...	7.07	
Winter Helping Hand Chopper - Left Curve	7.05	D
Winter Helping Hand Chopper - Left Curve-Titan...	7.05	
Winter Helping Hand Chopper - Right Curve	7.05	E
Winter Helping Hand Chopper - Right Curve-Titan...	7.05	
Wire Snare Loop For Ultrata Lens Cutter (Five)	19.01	
Wire Snare Loop For Ultrata Lens Cutter (One)	19.01	
Wise Iris and Capsule Retractor	15.02	C

Z

Ziegler Cilia Forceps, 3-1/2", Smooth	13.10	E
Ziegler Knife-Needle 4-1/2", Size 0, 3mm Blade	11.01	G
Ziegler Knife-Needle 4-1/2", Size 1, 5mm Blade	11.01	
Ziegler Knife-Needle 4-1/2", Size 2, 6mm Blade	11.01	
Ziegler Knife-Needle 4-1/2", Size 3, 7mm Blade	11.01	



ELEVATING THE QUALITY OF CARE IN OPHTHALMOLOGY
800-637-4346



ALPHABETICAL INDEX

Notes

31.11



ELEVATING THE QUALITY



ACOR

1-800-263-3557





Elevating The Quality Of Care In Ophthalmology

*5460 Beaumont Center Blvd., Suite 500, Tampa, Florida 33634
800-637-4346 • Tel: 831-885-5050 • Fax: 813-885-9346
Email: Info@RheinMedical.com * Website: www.RheinMedical.com*

